



Surface Mounted Chip LED

Model No. : LS-SP170YG34-5

■ Features :

- Compatible with automatic placement equipment
- Compatible with reflow solder process

■ Applications :

- Automotive_Telecommunication
- Indicators
- LCD Back-lights
- Illuminations

Dice Material	Light Color	Lens Color
GaP	Yellow Green	Water Clear

Absolute Maximum Ratings

(Ta=25°C)

Item	Symbol	Maximum	Unit
Power Dissipation	P _D	78	mW
Continuous Forward Current	I _F	30	mA
Peak Forward Current (1/10 Duty Cycle 0.1ms Pulse Width)	I _{FP}	100	mA
Reverse Voltage	V _R	5	V
Derating Linear From 25°C		0.4	mA/°C
Operating Temperature Range	Topr	-30 to +80	°C
Storage Temperature Range	Tstg	-40 to +85	°C

Electrical / Optical Characteristics

(Ta=25°C)

Item	Symbol	Condition	Min.	Typ.	Max.	Unit
Forward Voltage	V _F	IF=5mA		1.9	2.3	V
Reverse Current	I _R	VR=5V			10	uA
Peak Emission Wavelength	λ _P	IF=5mA		568		nm
Dominant Wavelength	λ _D	IF=5mA		570		nm
Viewing Angle	2θ 1/2	IF=5mA		130		Deg
Luminous Intensity	I _V	IF=5mA	1.2	2.2		mcd

ISSUE	DIMENSION NO :	VERSION :	DATE :
		A	2007/05/14
	APPROVAL :	CHECK :	EDIT :



◆ Packing coding principle

Notice: Bin code: luminous intensity / wavelength / voltage.

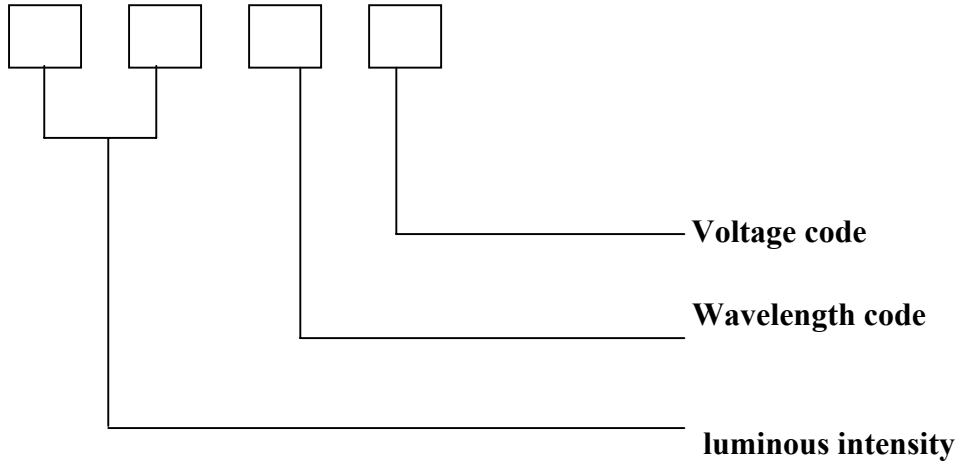

◆ The Luminous Intensity Grade of Yellow Green Chip-LED Products

● Test Condition : @ 5mA

Range,mcd	Bin code
1.2/2.2	C1
2.2/3.6	C2

◆ Dominant Wavelength Grade of Yellow Green Chip-LED Products

● I type @5mA

BIN	Range
0	568/570
1	570/572
2	572/574
3	574/576
4	576/578

◆ Forward Voltage Grade of Yellow Green Chip-LED Products

● I type @ 5mA

BIN	Range	BIN	Range
5	1.9/2.0	6	2.0/2.1



◆ **Precautions For Use :**

- Over - current - proof

Customer must apply resistors for protection, otherwise slight voltage shift will cause big current change (Burn out will happen)

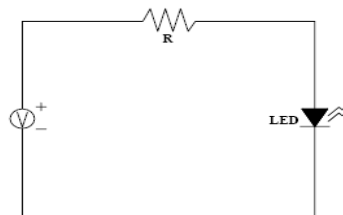

- Storage

1. The operation of temperature and R.H. are : $5^{\circ}\text{C} \sim 30^{\circ}\text{C}$, R.H.60% Max..
2. Once the package is opened, the products should be used within 72 hrs. Otherwise, they should be kept in a dampproof box with desiccating regent. Considering the tape life, we suggest our customers to use our products within 1 year (from production date) .
3. It's recommended to bake before soldering when the package is unsealed after 72 hrs. The condition is : $80^{\circ}\text{C} \pm 5^{\circ}\text{C}$ for 24hrs.

◆ **Soldering Iron :**

- Temperature at tip of iron : 300°C Max. (25W Max.)
- Soldering time : $5 \pm 1\text{sec}$.

◆ **Wave Soldering Temp. / Time :**

Temp.($^{\circ}\text{C}$)		Time(Sec)	
a	25	T1~T2	60 ± 20
b	130 ± 10	T2~T3	
c	185	T3~T6	
d	250 ± 3	T4~T5	3 ± 2

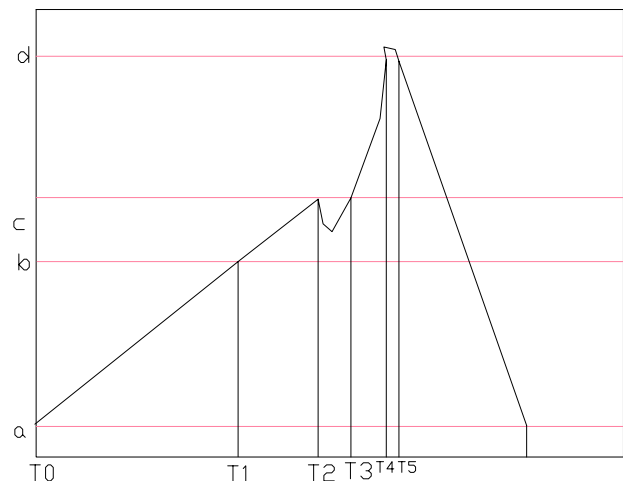



◆ Typical Electro-Optical Characteristic Curve :

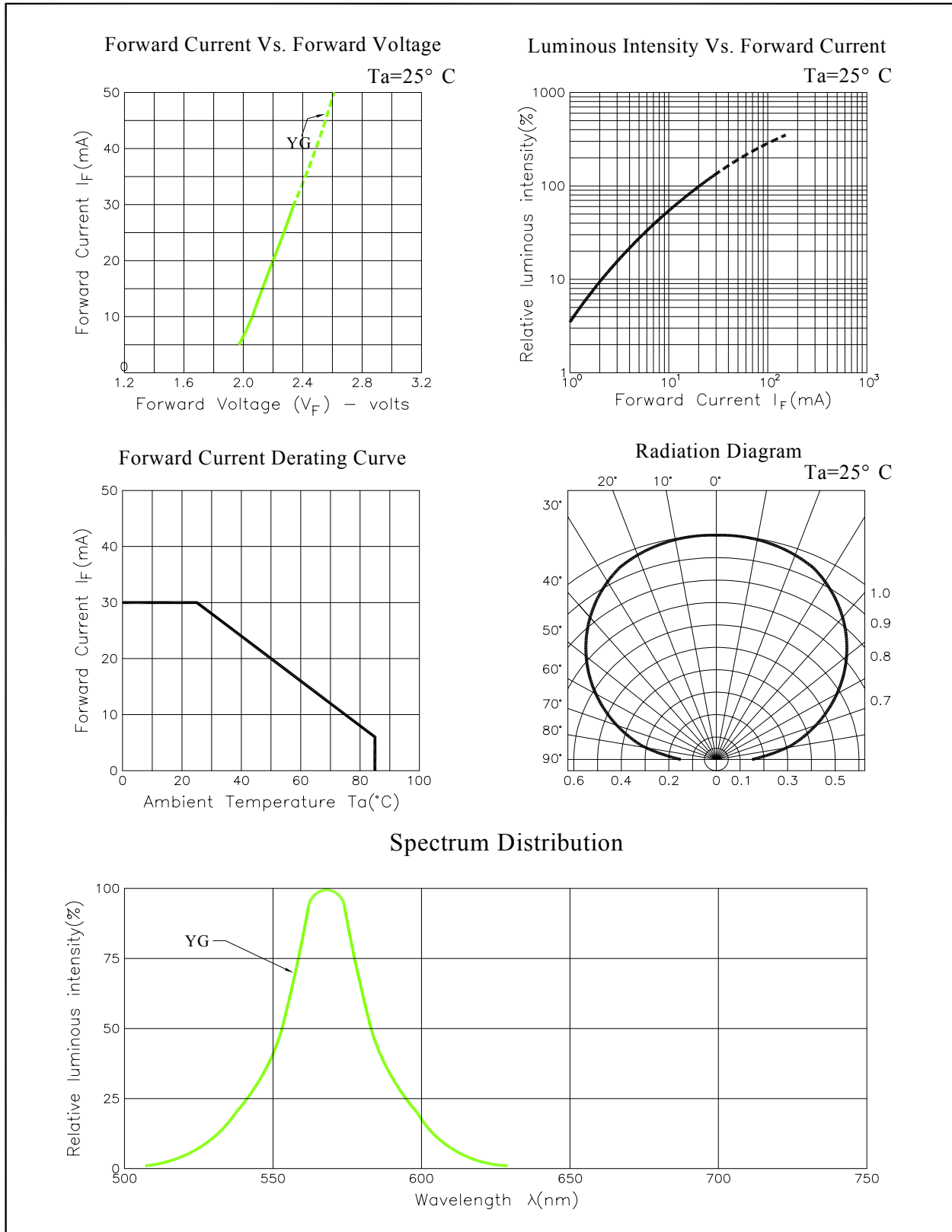



◆ Package Dimensions of Device (LS-SP170 Series)

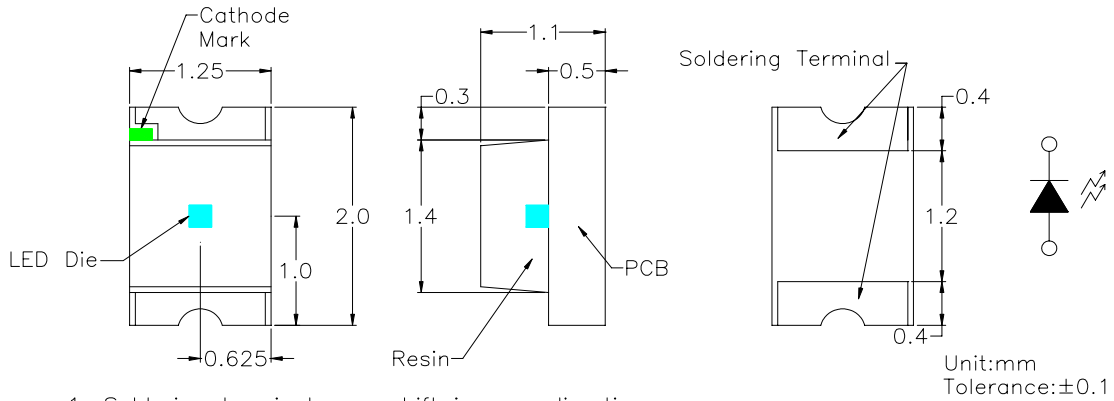

1. Soldering terminal may shift in x, y direction.
2. Polarity referring onto the cathode mark is reversed on the HR/UR/SR

◆ Recommended Soldering Pad Dimensions

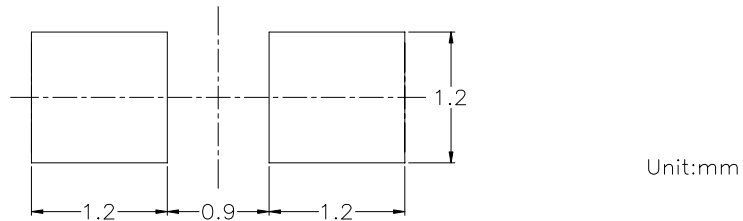

◆ Tape Specification : 3000pcs Per Reel

Packing Size													
Item	W	P1	E	F	Do	D1	Po	10Po	P2	Ao	Bo	Ko	t
Spec.	8.00	4.00	1.75	3.50	1.50	1.00	4.00	40.00	2.00	1.40	2.25	1.35	0.23
Tolerance	±0.20	±0.10	±0.10	±0.05	$^{+0.10}_{-0.00}$	±0.05	±0.05	±0.20	±0.05	±0.10	±0.10	±0.10	±0.05

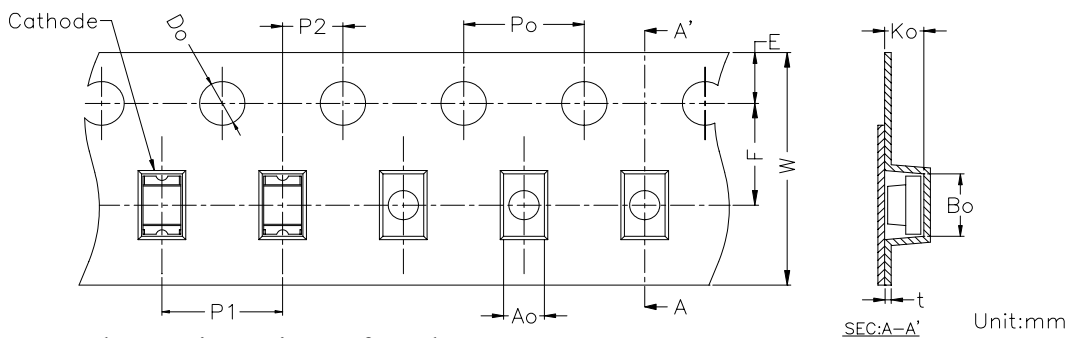

◆ Package Dimensions of Reel

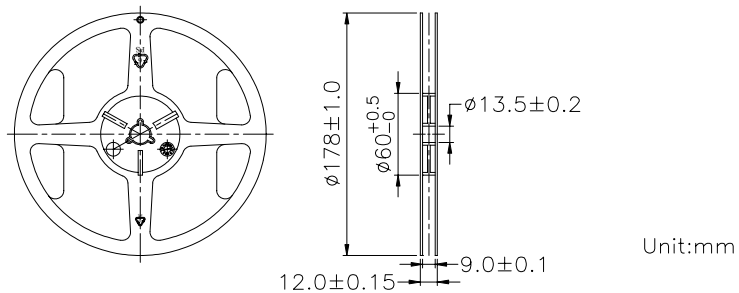



◆Packing and Shipping Spec.

