

Data Sheet

Customer: _____
Part No: CL-SP4208GRB-08-02
Sample No: _____
Description: 4208 Red/Green/Blue SMD
Item No: _____

Customer			
Check	Inspection	Approval	Date

Features

- Extremely wide viewing angle,
- Suitable for all SMT assembly and solder process.
- Available on tape and reel.
- Moisture sensitivity level: Level 4
- Package:1000-4000pcs/reel.)
- RoHS compliant.

Description)

The Green source color devices are made with InGaN on Substrate Light Emitting Diode

The Red source color devices are made with AlGaInP on Substrate Light Emitting Diode

The Blue source color devices are made with InGaN on Substrate Light Emitting Diode



ATTENTION
OBSERVE PRECAUTIONS
FOR HANDLING
ELECTROSTATIC
DISCHARGE
SENSITIVE
DEVICES

注意：操作时应注意静电敏感
释放设备装置

Applications

- Optical indicator
- Indoor display
- Automotive lighting)

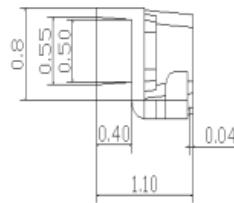

- Backlight for LCD, switch and Symbol, display
- Tubular light application
- General use

Package Dimensions

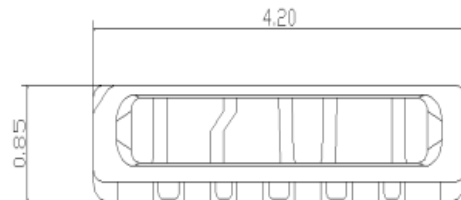

Recommended Soldering Pattern

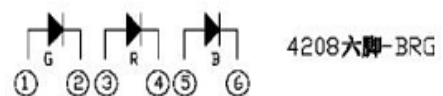
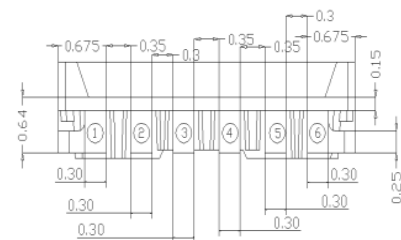
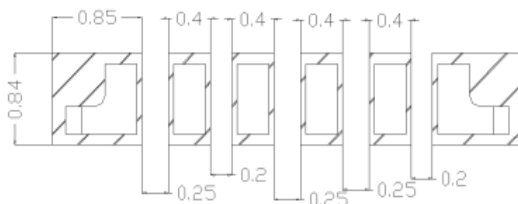

Notes:

1. All dimension units are millimeters.)
2. All dimension tolerance is $\pm 0.15\text{mm}$ unless otherwise noted.

Selection Guide

Part No.	Dice	Lens Type	Luminous intensity(mcd) 20mA		Viewing Angle
			Min.	Typ.	2q1/2
4208GRB-08A	Blue(InGaN)	Aerosol colloid	800	1000	115°
	Red(AlGaInP)	Aerosol colloid	800	1000	
	Green(InGaN)	Aerosol colloid	1800	2000	

Note:

- 2q1/2 is the angle from optical centerline where the luminous intensity is 1/2 the optical centerline value.
- The above luminous intensity measurement allowance tolerance is $\pm 10\%$.

Electrical / Optical Characteristics at Ta=25°C

Parameter	Symbol	Red			Green			Blue			Units	Test Condi- tions
		Min.	Typ.	Max	Min.	Typ.	Max	Min.	Typ.	Max		
Forward Voltage	VF	1.8	2.0	2.3	2.7	3.0	3.2	2.8	3.0	3.3	V	IF=20mA
Reverse Current	IR	--	--	10	--	--	10	--	--	10	uA	VR = 5V
Dominate Wavelength	λ_d	615	625	630	520	525	530	460	465	470	nm	IF=20mA

Absolute Maximum Ratings at Ta=25°C

Parameter	Symbol	Value (Red)	Value (Green)	Value (Blue)	Units
Power Dissipation	Pd	100	100	100	mW
Forward Current	IF	30	30	30	mA
Peak Forward Current [1]	IFP	100	100	100	mA
Reverse Voltage	VR	5	5	5	V
Electrostatic Discharge (HBM)	ESD	2000	1000	1000	V
Operating Temperature	Topr	-40 ~ +85			°C
Storage Temperature	Tstg	-40 ~ +100			°C

Note:

- 1/10 Duty cycle, 0.1ms pulse width.
- The above forward voltage measurement allowance tolerance is $\pm 0.1V$.
- The above dominate wavelength measurement allowance tolerance is $\pm 1nm$.

Typical optical characteristics curves

Ambient Temperature vs. Forward Current

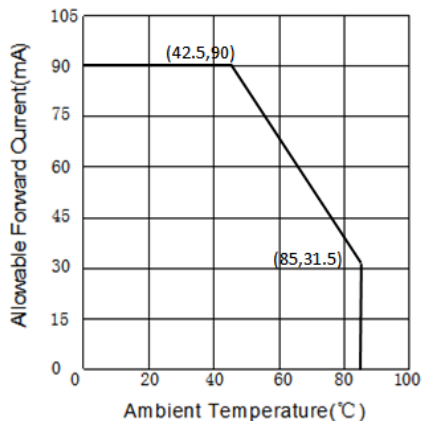

Forward Current VS. Relative Intensity

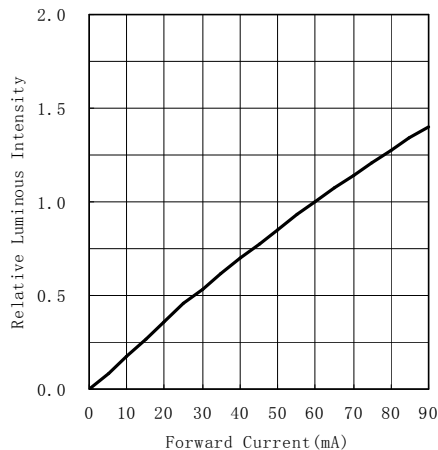

Forward Voltage VS. Forward Current

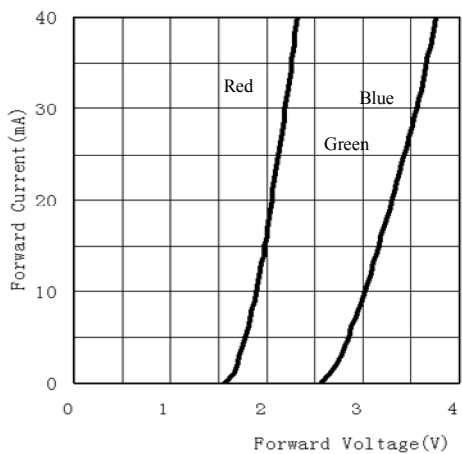

Ambient Temperature VS. Relative Intensity

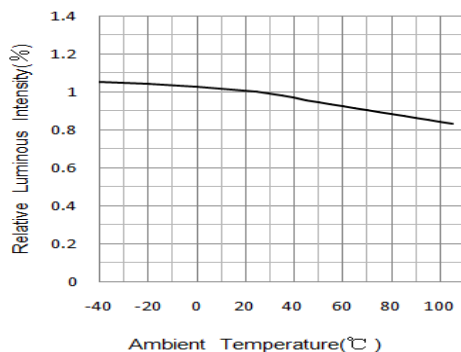

Relative spectral emission

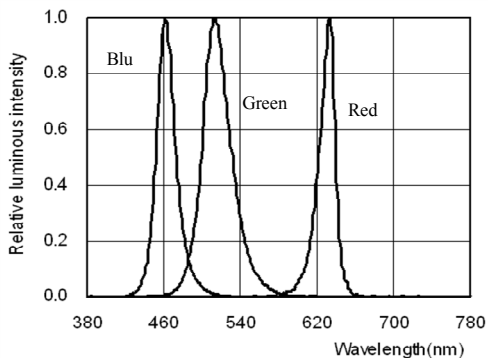

Radiation diagram

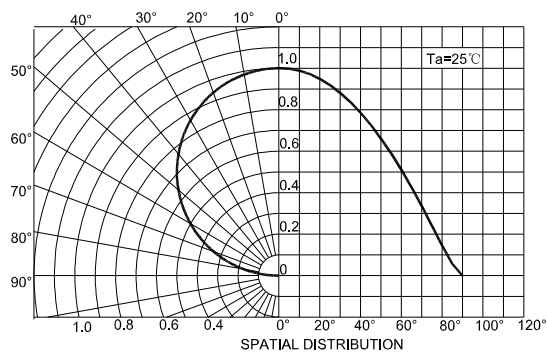

Reliability Test Items And Conditions

Test Items	Ref. Standard	Test Condition	Time	Quantity	Ac/Re
Reflow	JESD22-B106	Temp:260°Cmax T=10 sec	3 times.	22Pcs.	0/1
Temperature Cycle	JESD22-A104	120°C±5°C 30 min. ↑↓5 min -40°C±5°C 30 min.	100 Cycles	22Pcs.	0/1
High Temperature Storage	JESD22-A103	Temp:100°C±5°C	1000Hrs.	11Pcs.	0/1
Low Temperature Storage	JESD22-A119	Temp:-40°C±5°C	1000Hrs.	11Pcs.	0/1
Life Test	JESD22-A108	Ta=25°C±5°C IF=20*3mA	1000Hrs.	11Pcs.	0/1
High Temperature High Humidity Life Test	JESD22-A101	85°C±5°C/ 85%RH IF=20*3mA	1000Hrs.	11Pcs.	0/1

Test Items	Symbol	Test Condition	Failure Criteria	
			Min.	Max.
Forward Voltage	VF	IF=20mA*3	--	U.S.L*)x1.1
Reverse Current	IR	VR = 5V	--	U.S.L*)x2.0
Luminous Flux	Lm	IF=20mA*3	L.S.L*)x0.7	--

U.S.L: Upper Specification Limit

L.S.L: Lower Specification Limit

*The technical information shown in the data sheets are limited to the typical characteristics and circuit examples of the referenced products. It does not constitute the warranting of industrial property nor the granting of any license.

SMT Reflow Soldering Instructions

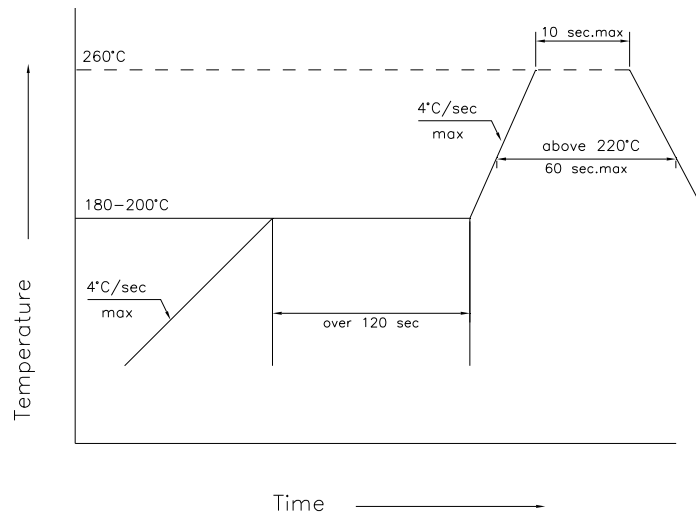

- 1.Reflow soldering should not be done more than two times.
- 2.When soldering , do not put stress on the LEDs during heating

Soldering iron

- 1.When hand soldering, keep the temperature of iron below less 300°C less than 3 seconds
- 2.The hand solder should be done only one times

Repairing

Repair should not be done after the LEDs have been soldered . When repairing is unavoidable , a double-head soldering iron should be used (as below figure). It should be confirmed in advance whether the characteristics of LEDs will or will not be damaged by repairing.

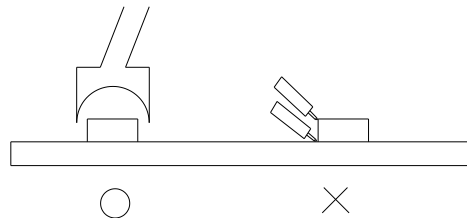

Cautions

The encapsulated material of the LEDs is silicone. Therefore the LEDs have a soft surface on the top of package. The pressure to the top surface will be influence to the reliability of the LEDs. Precautions should be taken to avoid the strong pressure on the encapsulated part. So when use the picking up nozzle, the pressure on the silicone resin should be proper.

Handling Precautions

Compare to epoxy encapsulant that is hard and brittle, silicone is softer and flexible. Although its characteristic significantly reduces thermal stress, it is more prone to damage by external mechanical force. As a result, Special handling precautions must be observed during assembling using silicone encapsulated LED products, Failure to comply might leads to damage and premature failure of the LED.

1. Handle the component along the side surface by using forceps or appropriate tools; do not directly touch or Handle the silicone lens surface, it may damage the internal circuitry.

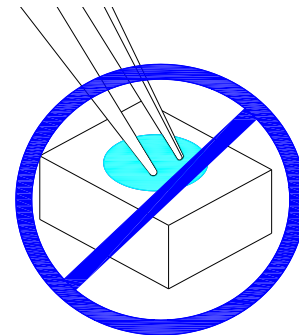
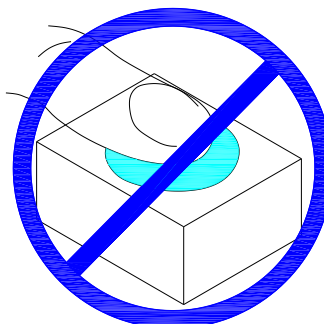
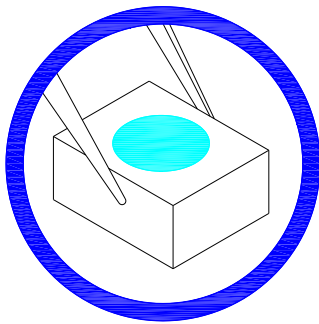

2. The outer diameter of the SMD pickup nozzle should not exceed the size of the LED to prevent air leaks. The inner diameter of the nozzle should be as large as possible. A pliable material is suggested for the nozzle tip to avoid scratching or damaging the LED surface during pickup. The dimensions of the component must be accurately programmed in the pick-and-place machine to insure precise pickup and avoid damage during production.

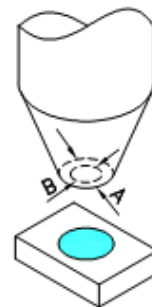

3. Do not stack together assembled PCBs containing LEDs. Impact may scratch the silicone lens or damage the internal circuitry

4. Not suitable to operate in acidic environment, PH<7

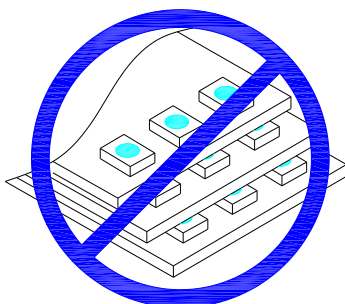

5.LED operating environment and sulfur element composition cannot be over 100PPM in the LED mating usage material.

6.When we need to use external glue for LED application products, please make sure that the external glue matches the LED packaging glue. Additionally ,as most of LED packaging glue is silica gel, and it has strong Oxygen permeability as well as strong moisture permeability; in order to prevent external material from getting into the inside of LED, which may cause the malfunction of LED, the single content of Bromine element is required to be less than 900PPM,the single content of Chlorine element is required to be less than 900PPM,the total content of Bromine element and Chlorine element in the external glue of the application products is required to be less than 1500PPM

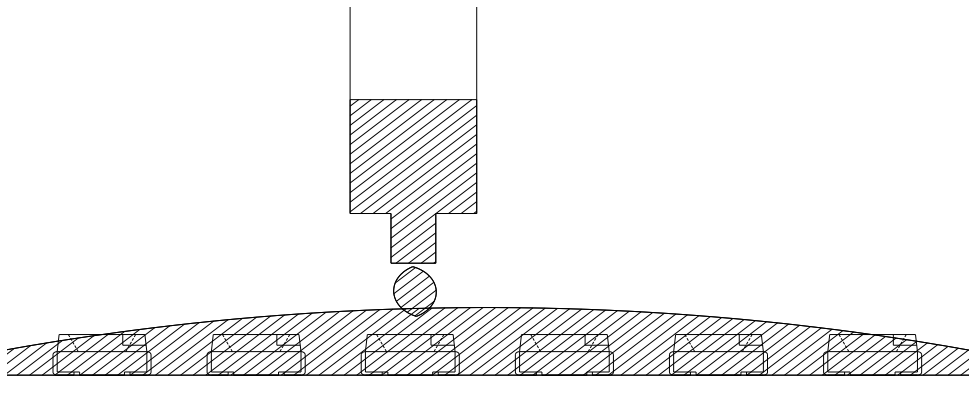

7.Other points for attention, please refer to our LED user manual

Label

IV: Luminous intensity rank

WD: Dominate Wavelength

VF: Forward voltage rank

QTY:

•Dimensions of Tape (Unit: mm)

Tape

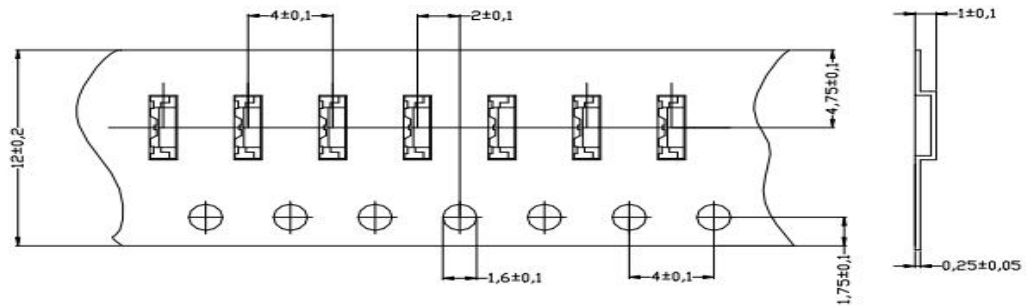

•Dimensions for Reel

Reel Dimensions

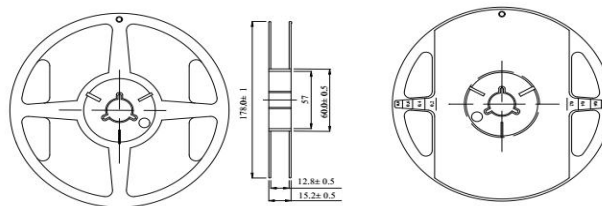

Notes:

1. All dimensions are in mm, tolerance is ±2.0mm unless otherwise noted.
2. Specifications are subject to change without notice.

Moisture Resistant Packaging

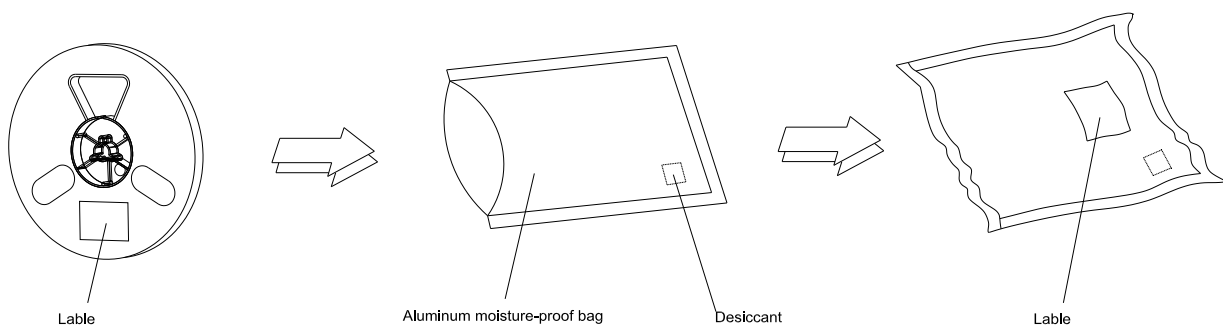

Note: The tolerances unless mentioned is ±0.1mm , Unit: mm