



## Data Sheet

---

Customer: \_\_\_\_\_

Part No: \_\_\_\_\_

CL-SFDZ3535UVA-365-B-05(H)

Sample No: \_\_\_\_\_

Description: \_\_\_\_\_

3535 SMD 365nm UVA

Item No: \_\_\_\_\_

Customer			
Check	Inspection	Approval	Date



## Aatures

- Long service life
- High brightness
- Energy saving and environmental protection
- Low DC voltage operation
- Quick response
- Photometric tunable
- Short wavelength, strong penetration
- Strong antistatic ability
- Eutectic process
- RoHS compliant

## Applications

- All kinds of sterilization
- UV light therapy, beauty and manicure
- Anti-counterfeit detection
- Photocatalytic air purification
- UV curing
- Plant lighting
- Printing equipment

## Radiation Pattern

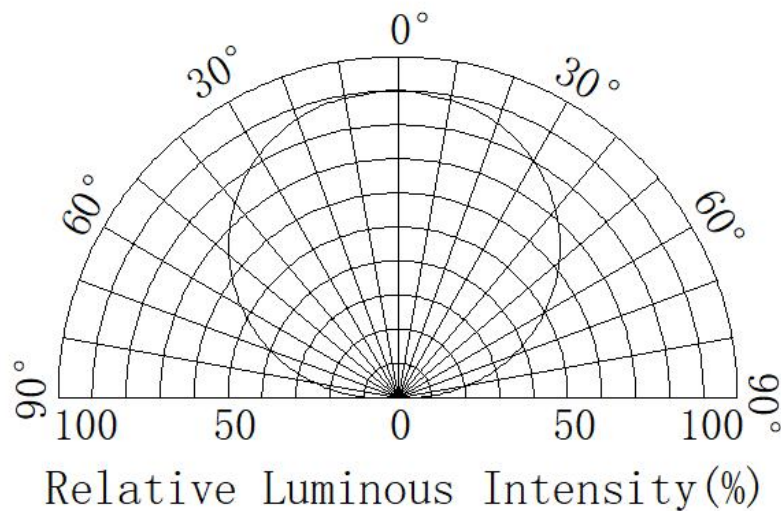

**Typical Optical/ Electrical Characteristics @T<sub>J</sub>=25°C**

Item	Symbol	Condition	Min.	Typ.	Max.	Unit
Forward Voltage	V <sub>F</sub>	IF=500mA	3.2	--	3.8	V
		IF=700mA				
Reverse Current	I <sub>R</sub>	VR=5v	--	--	5	μA
50% Power Angle	2θ <sub>1/2</sub>	IF=500mA	---	120	---	deg
		IF=700mA				
Light radiated power	P	IF=500mA	700	850	1000	mw
		IF=700mA	900	1200	1500	
Recommend Forward Current	I <sub>F</sub>	--	500	--	700	mA
Chromaticity	& λ d)	IF=500mA	365	--	370	nm
		IF=700mA				
Junction temperature	T <sub>J</sub>	IF=500mA	--	125	--	°C
		IF=700mA				
Thermal Resistance, Junction to Case	R <sub>JP</sub>	IF=500mA	--	8	--	°C/W
		IF=700mA				

- Notes: 1. Tolerance of measurement of forward voltage ±0.1V.  
 2. Tolerance of measurement of peak Wavelength ±2.0nm.  
 3. Tolerance of measurement of luminous intensity ±5%.

**Absolute Maximum Rating**

Item	Symbol	Absolute Maximum Rating	Unit
Forward Current	I <sub>F</sub>	700	mA
Pulse Forward Current*	I <sub>FP</sub>	1000	mA
Reverse Voltage	V <sub>R</sub>	5	V
Power Dissipation	P <sub>O</sub>	2000	mW
Operation Temperature	T <sub>OPR</sub>	-40~+80	°C
Storage Temperature	T <sub>STG</sub>	-40~+100	°C
Lead Soldering Temperature*	T <sub>SOL</sub>	Max. 260°C for 3sec Max.	

\*IFP Conditions: Pulse Width ≤ 10msec duty ≤ 1/10

\* All high power emitter LED products mounted on aluminum metal-core printed circuit board, can be lighted directly, but we do not recommend lighting the high power products for more than 5 seconds without a appropriate heat dissipation equipment.

\*Re-flow, wave peak and soak-stannum soldering etc. is not suitable for High power integrated light source.

\*Suggest to solder it by professional high power LED soldering machine.

\*Can use invariable-temperature searing-iron with soldering condition : ≤ 260 degree less than 3 seconds.

### Wavelength Characteristics

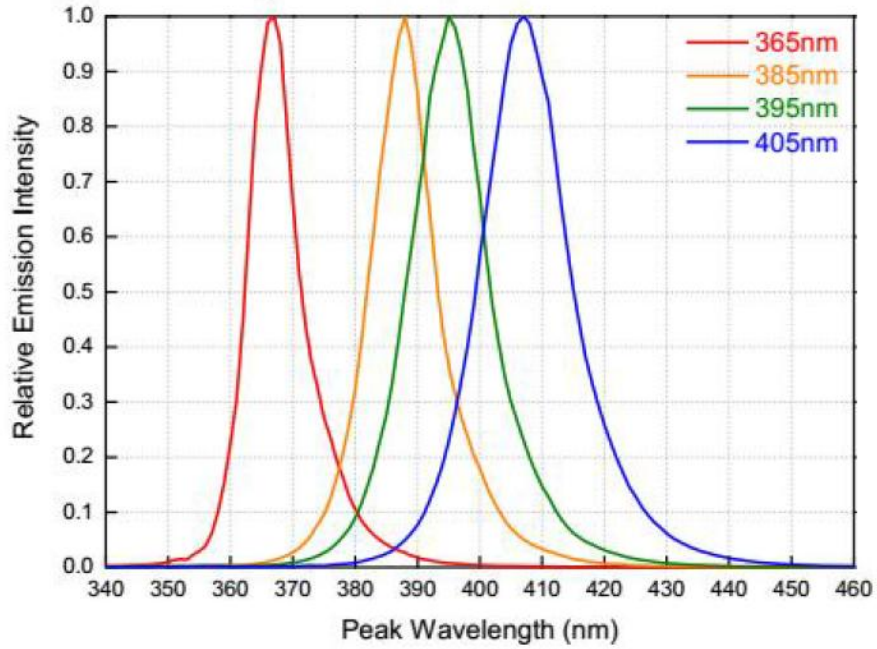

### Forward Current VS. Relative Intensity

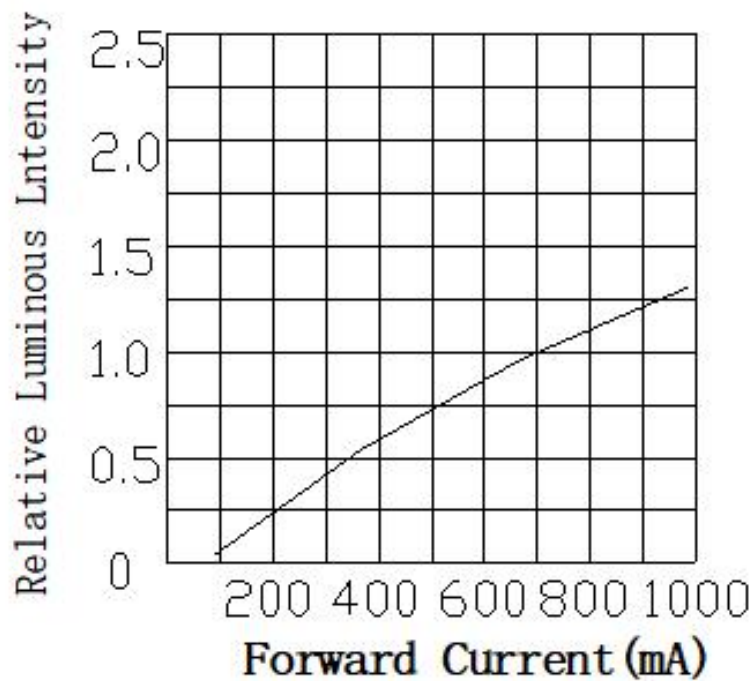

**Ambient Temperature .  
VS Forward Current**

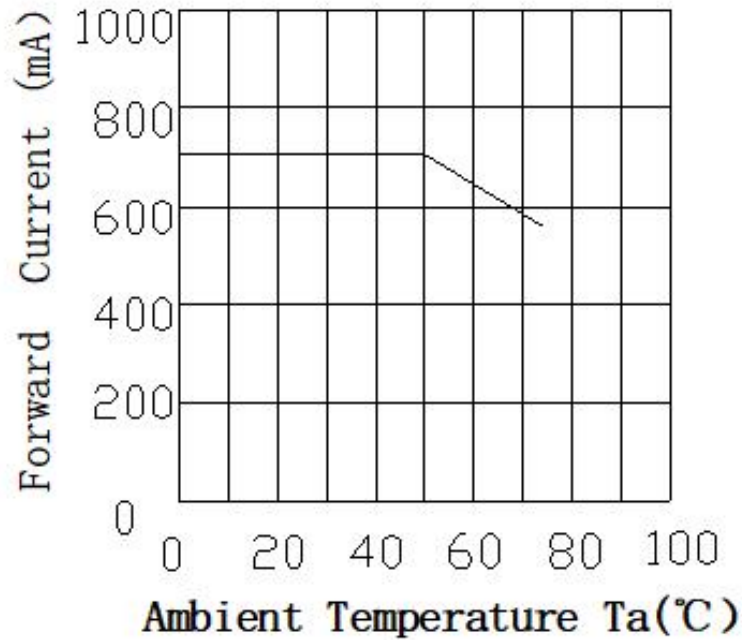

**Forward Current VS  
Forward Voltage**

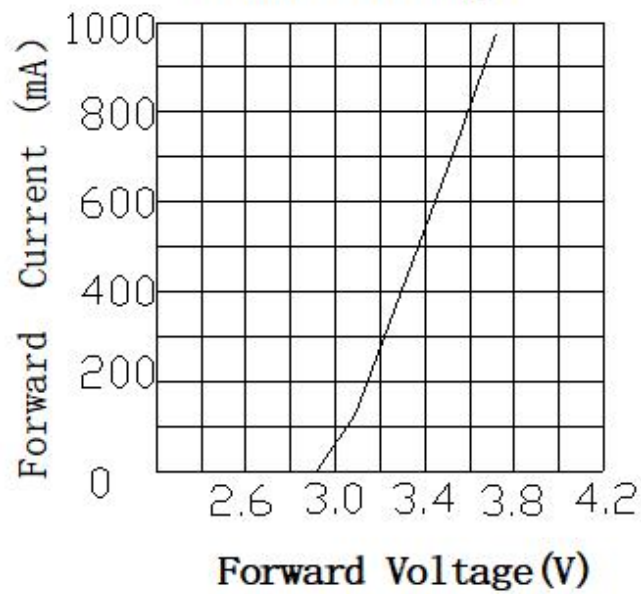

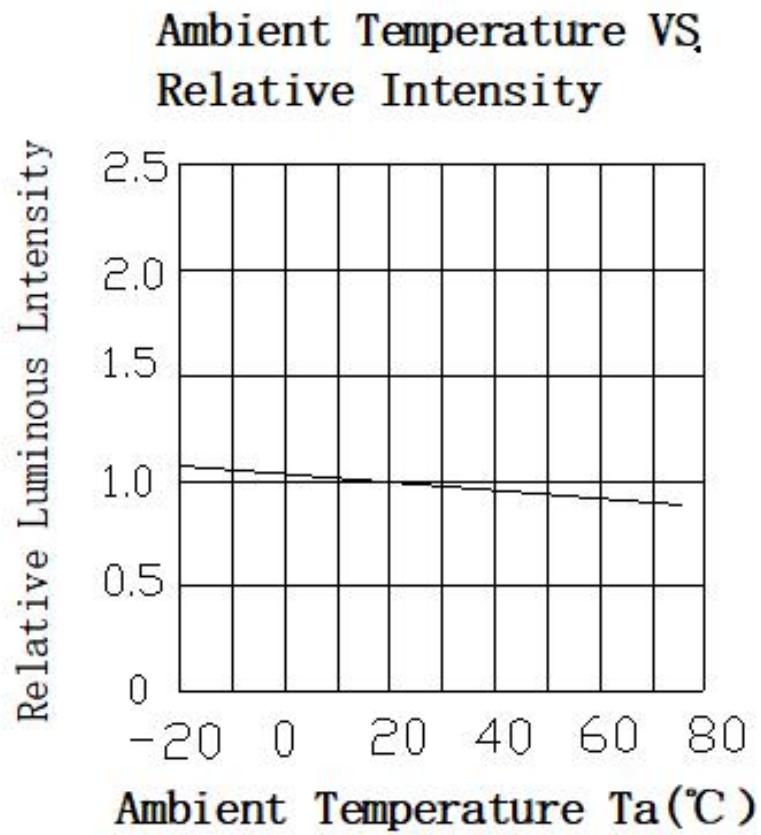

The connection method of chips :

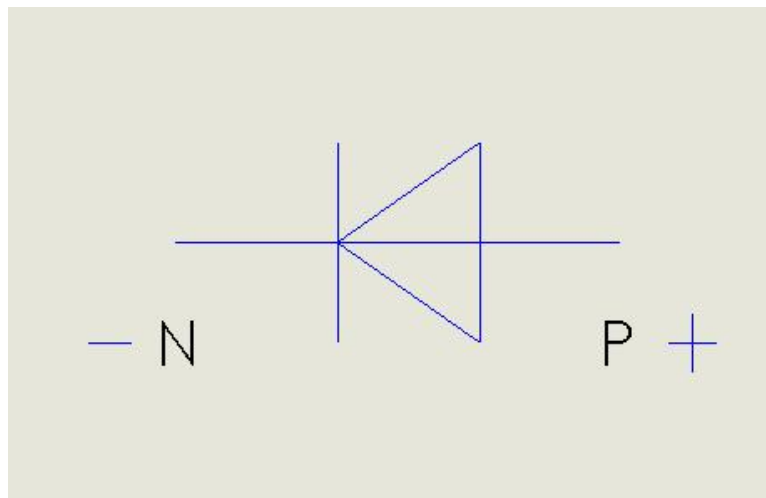

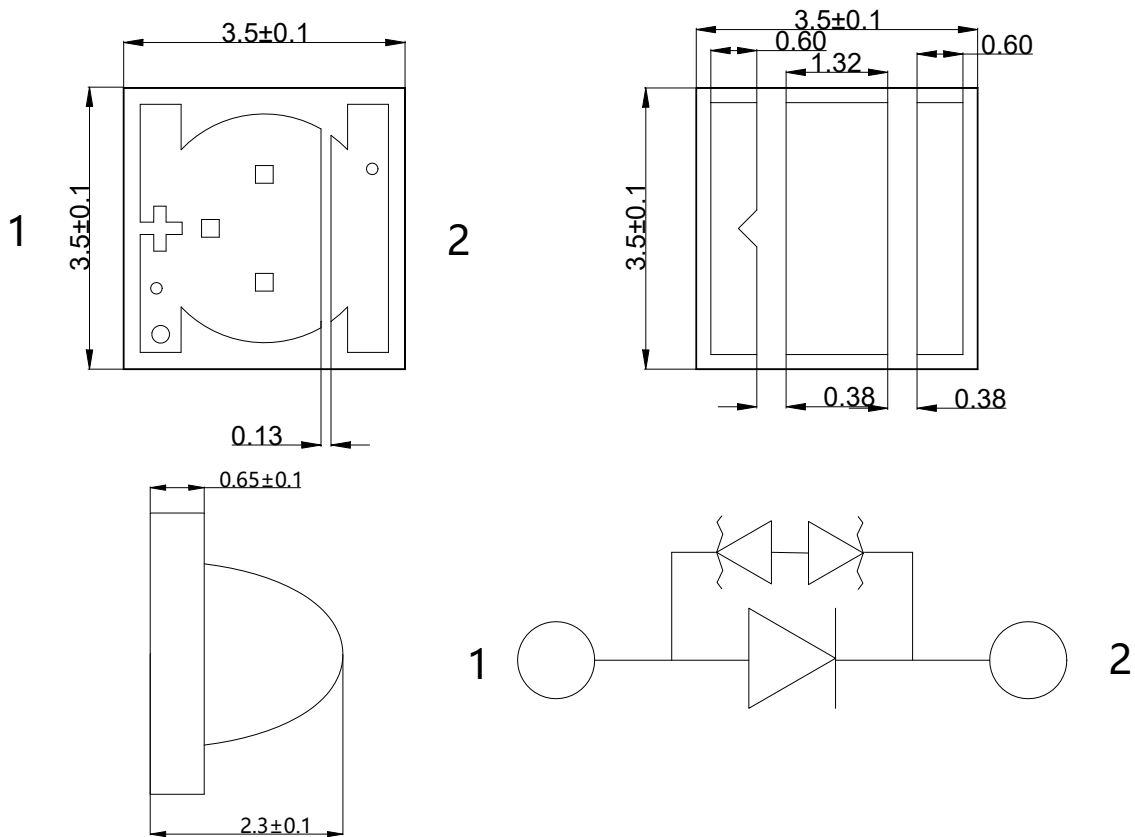
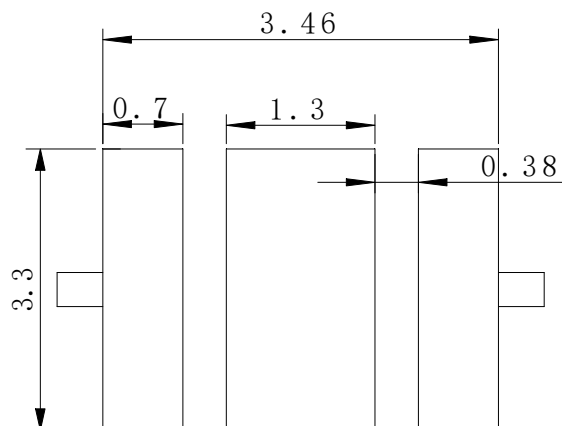
**Package Dimensions (MM)**

**Recommended Soldering Patter (MM)**

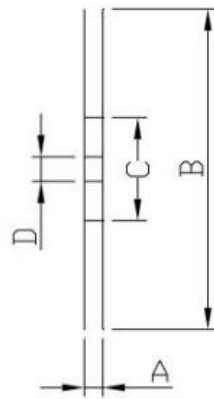
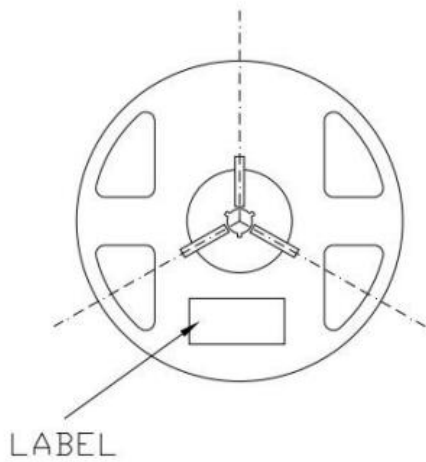
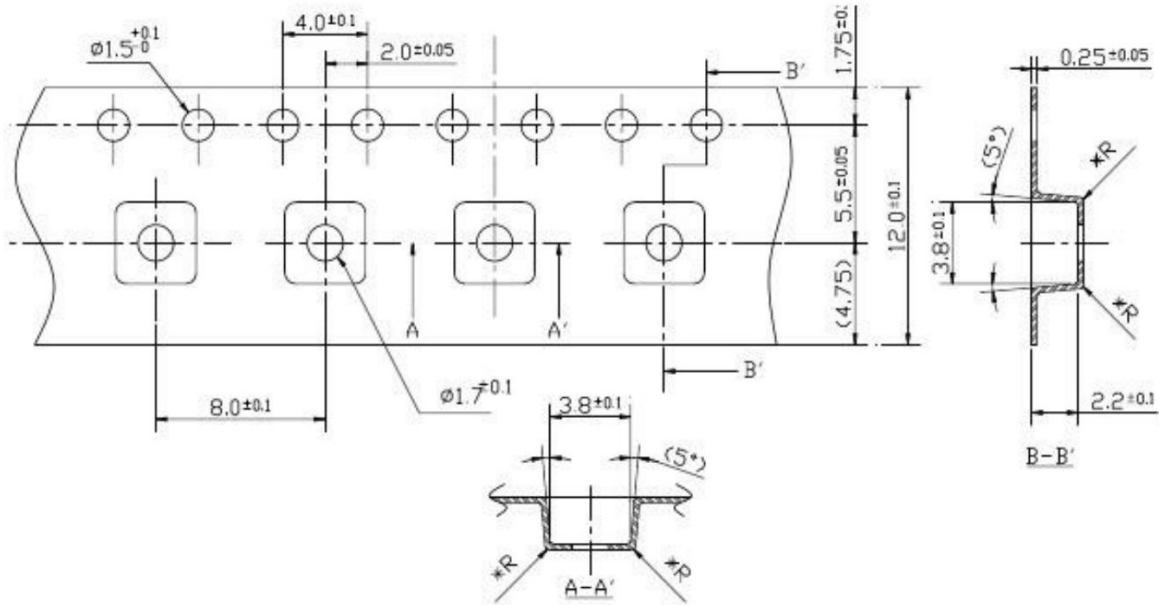
- Notes:
1. All dimension units are millimeters.
  2. All dimension tolerance is  $\pm 0.2$ mm unless otherwise noted.
  3. The brass column of heat sink of the high power LED is Anode. Please pay more attention to the necessary installation, when installing The heat dissipate on equipments and connecting the electric circuit in avoid of short circuit and destroying

**Packaging Information:**

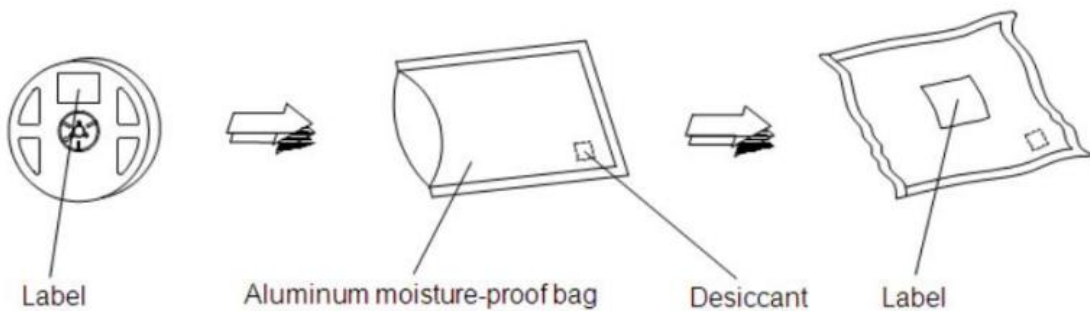
A	12mm
B	330mm
C	21mm
D	13mm





**Product access and installation:**

Before opening the electrostatic shielding bag, it is required to confirm whether the working table and production equipment are grounded. The operator shall wear electrostatic bracelet, gloves or fingertips for operation. After opening the package, the operator should use tweezers to hold both sides of the lamp bead to avoid direct contact with the front cover plate of the lamp bead. The workplace should be free of VOC pollution. Unnecessary pollution will lead to the strong absorption of the UV emitted from the front and affect the light power.

The lamp bead cover plate is a fragile component. Knocking, vibration, prying, clamp and other operations are easy to cause the cover plate to break and affect the use.

**\* welding of products:**

It is recommended to use low temperature solder paste for reflow welding, and the temperature curve can refer to the following figure:

**Note:**

- 1) The actual temperature curve shall depend on the type, proportion and Different reflow soldering equipment, substrate materials, etc And adjustment;
- 2) It is recommended to do more tests before batch welding to ensure the best workers are used Art curve;
- 3) Improper return temperature and time may cause the bead surface The discoloration of the coating may cause the LED chip in the lamp bead to be desoldered and fail;
- 4) After reflow welding, the lamp beads should not be repaired again. When repair is inevitable, double head soldering iron must be used, and it is necessary to confirm in advance whether this way damages the characteristics of the lamp bead itself.

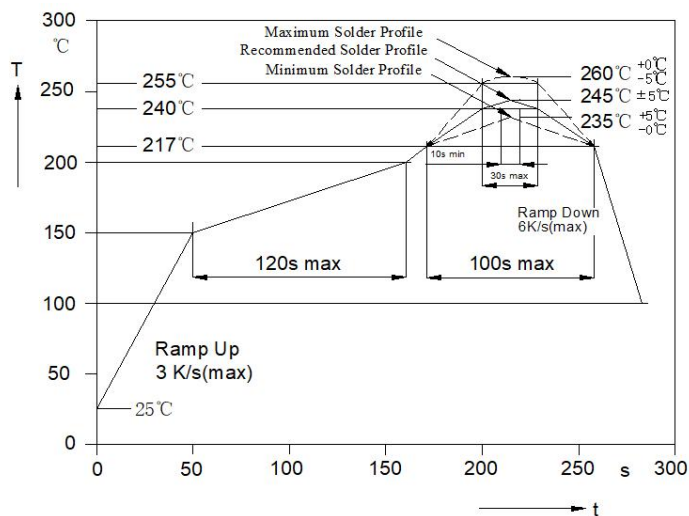

**specific definition of each temperature zone in the figure:**

Preheating zone: the heating rate is 1.0-3.0 °C / s, and the heating rate is too fast in the preheating zone, which is easy to make the mobility and composition of solder paste worsen, and easy to produce the phenomenon of tin explosion and solder bead.

Soakage zone: temperature 110-130 °C, time 90-100s, if the temperature is too low, there will be solder not melting after reflow (recommended temperature rise rate < 2 °C / S)

Back welding area: the peak temperature shall be set at 170-180 °C. It is recommended to adjust the melting time above 138 °C to 50-80 seconds.

Cooling zone: cooling rate < 4 °C / S

**Special note:**

1 for any other matters not mentioned in this specification, please call our sales department.

2 important safety tips:

This product will produce deep ultraviolet after correct operation and power on, and direct irradiation may cause harm to human skin and eyes. It is recommended to wear protective clothing, gloves and goggles during operation / use. It is strictly prohibited to directly irradiate the ultraviolet without taking protective measures, and it is strictly prohibited to directly look at the ultraviolet without wearing protective glasses.

