

## SAMPLE APPROVE SHEET

Customer Name: \_\_\_\_\_

Product description 5050 WARM/WHITE-1W  
 ( 각0.5W ) - 꺾인부분 (-) WARM

Product Name : CL-SFC530DWWDBW-3K,5.7K-05

Issue Date : \_\_\_\_\_ 2020-11-23 \_\_\_\_\_

Lens Color Code	C	Water Transparent
	T	Colored Transparent
	D	White Diffused
	<b>E</b>	<b>Colored Diffused</b>

Customer confirmation	Checked by	Prepared by



## Aatures

- Long operating life
- Highest flux
- Wide range of colors:2500K-25000K
- Lambertian radiation pattern
- More energy efficient than incandescent and most halogen lamps
- Low voltage DC operated
- Cool beam, safe to the touch
- Instant light (less than 100ns )
- Fully dimmable
- No UV
- Superior ESD protection
- Eutectic die band
- RoHS compliant

## Applications

- Reading lights (car, bus, aircraft)
- LCD Backlights/light Guides
- Fiber optic alternative/ Decorative / Entertainment
- Mini-accent/Up lighters/Down lighters/  
Orientation
- Indoor/Outdoor commercial and Residential  
Architectural
- Cove/Under shelf/Task
- Bollards/Security/Garden
- Portable (flashlight, bicycle)
- Edge-lit signs (Exit, point of sale)
- Automotive Exit (Stop-Tail-Turn,CHMSL,  
Mirror Side Repeat)
- Traffic signaling / Beacons / RailCrossing

and Wayside

## Radiation Pattern

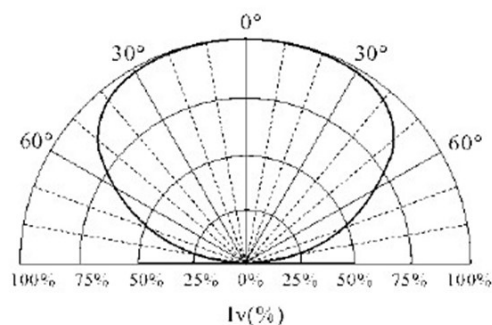

**Typical Optical/ Electrical Characteristics @T<sub>J</sub>=25°C**

Item	Symbol	Condition	Min.	Typ.	Max.	Unit
Forward Voltage SW	V <sub>F</sub>	IF=150mA	3.0	--	3.4	V
Forward Voltage TW	V <sub>F</sub>	IF=150mA	3.0	--	3.4	V
Reverse Current	I <sub>R</sub>	VR=5v	--	--	5	μA
50% Power Angle	2θ <sub>1/2</sub>	IF=150mA	--	140	--	deg
Luminous Intensity	φ <sub>v</sub>	IF=150mA	60	--	65	lm
Luminous Intensity	φ <sub>v</sub>	IF=150mA	55	--	60	lm
Recommend Forward Current	I <sub>F</sub>	--	--	150	--	mA
Chromaticity	T <sub>c</sub>	IF=150mA	5500	--	6000	k
Chromaticity	T <sub>c</sub>	IF=150mA	2800	--	3200	k
Color rendering	R <sub>a</sub>	IF=150mA	--	80	--	--
Junction temperature	T <sub>J</sub>	IF=150mA	--	125	--	°C
Thermal Resistance, Junction to Case	R <sub>JP</sub>	IF=150mA	--	8	--	°C/W

- Notes: 1. Tolerance of measurement of forward voltage ±0.1V.  
 2. Tolerance of measurement of peak Wavelength ±2.0nm.  
 3. Tolerance of measurement of luminous intensity ±5%.

**Absolute Maximum Rating**

Item	Symbol	Absolute Maximum Rating	Unit
Forward Current	I <sub>F</sub>	150	mA
Peak Forward Current*	I <sub>FP</sub>	300	mA
Reverse Voltage	V <sub>R</sub>	5	V
Power Dissipation	P <sub>D</sub>	1	W
Operation Temperature	T <sub>OPR</sub>	-40~+80	°C
Storage Temperature	T <sub>STG</sub>	-40~+100	°C
Lead Soldering Temperature*	T <sub>SOL</sub>	Max. 260°C for 5sec Max.	

\*I<sub>FP</sub> Conditions: Pulse Width ≤ 10msec duty ≤ 1/10

\* All high power emitter LED products mounted on aluminum metal-core printed circuit board, can be lighted directly, but we do not recommend lighting the high power products for more than 5 seconds without a appropriate heat dissipation equipment.

\*Re-flow, wave peak and soak-stannum soldering etc. is not suitable for this products.

\*Suggest to solder it by professional high power LED soldering machine.

\*Can use invariable-temperature searing-iron with soldering condition : ≤ 260 degree less than 3 seconds.

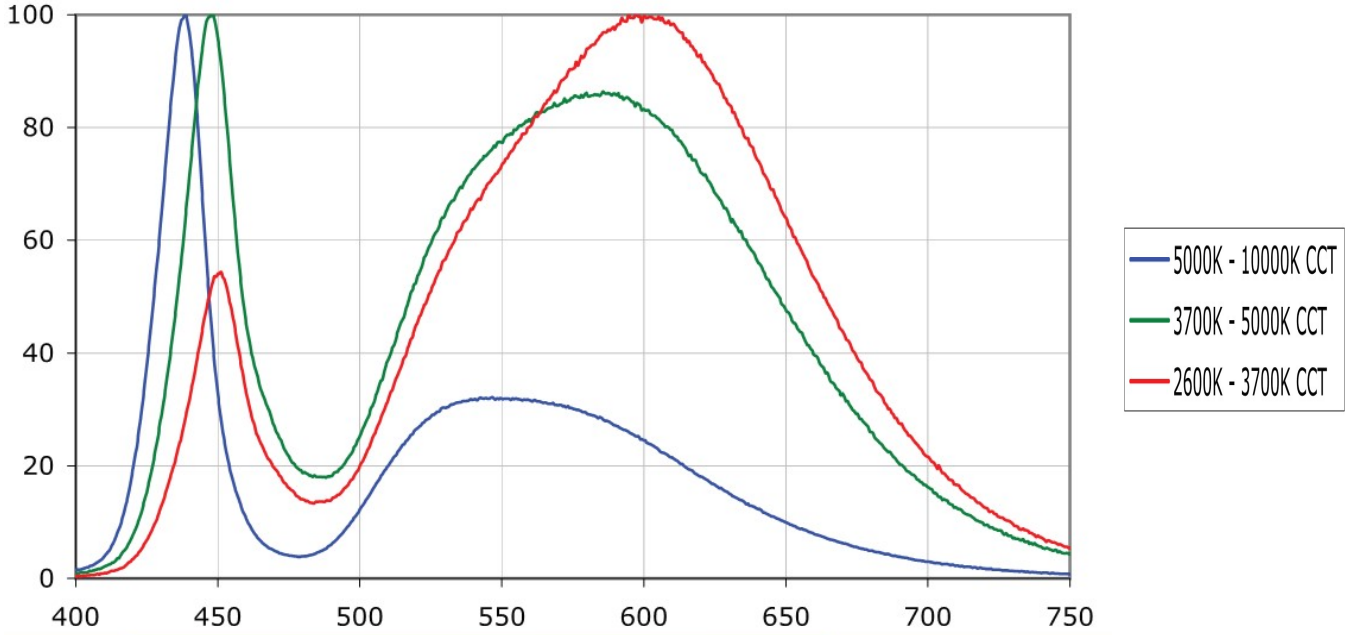
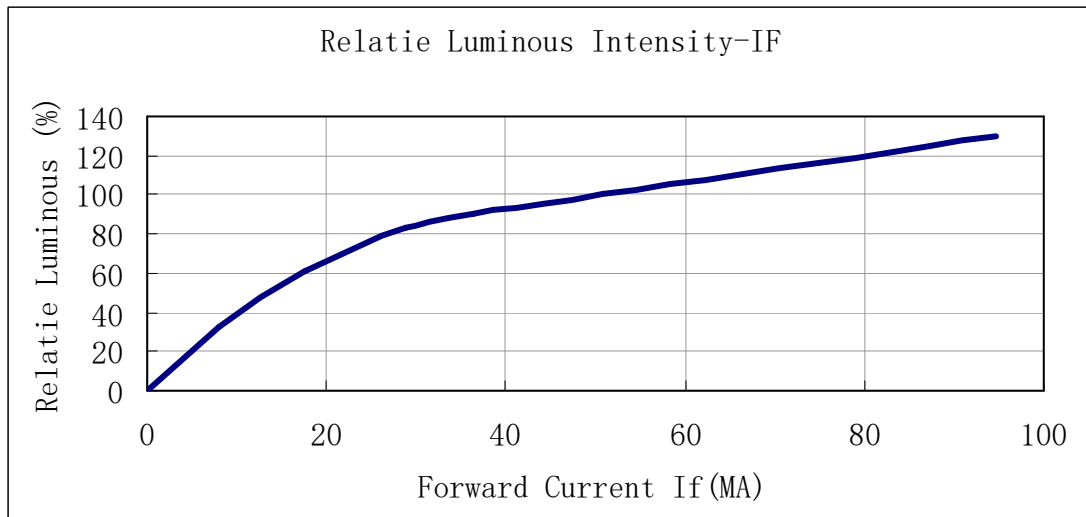
**Wavelength Characteristics**

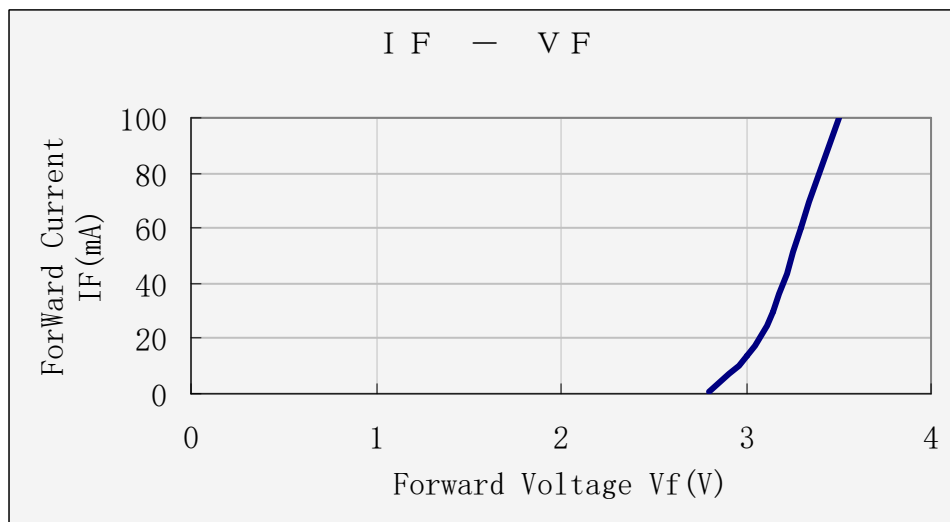
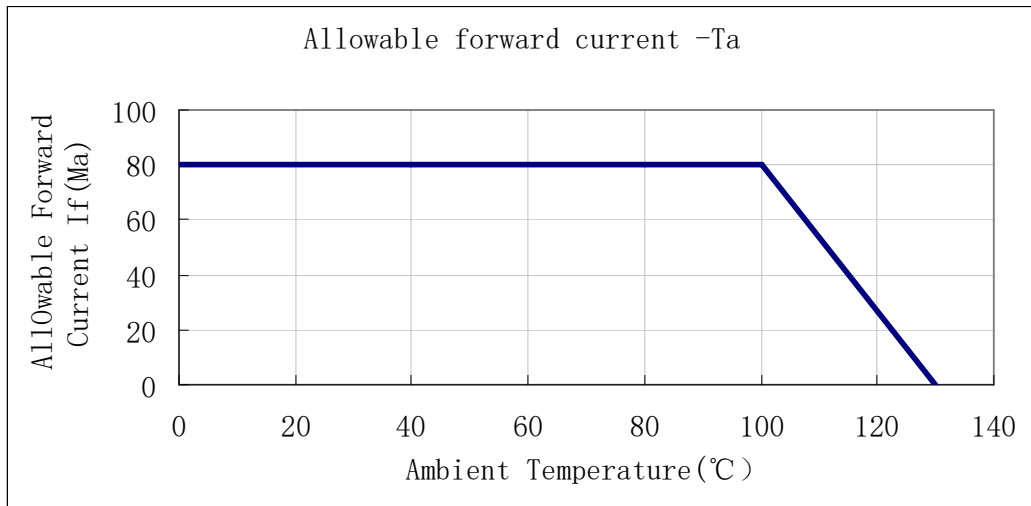
 Wavelength  $\lambda$  (nm)

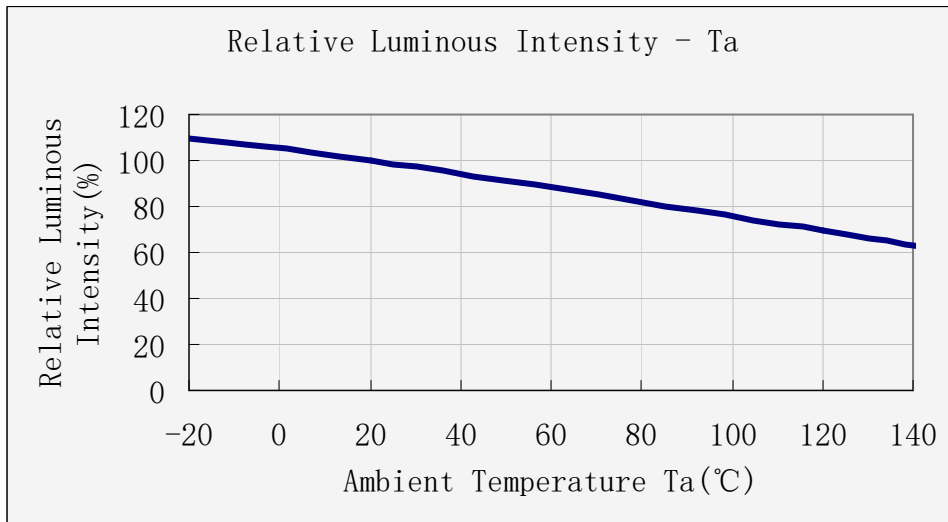

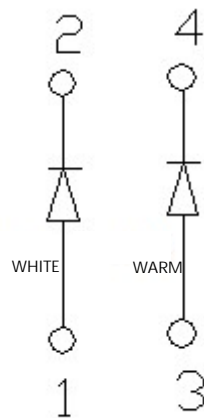

The connection method of chips :

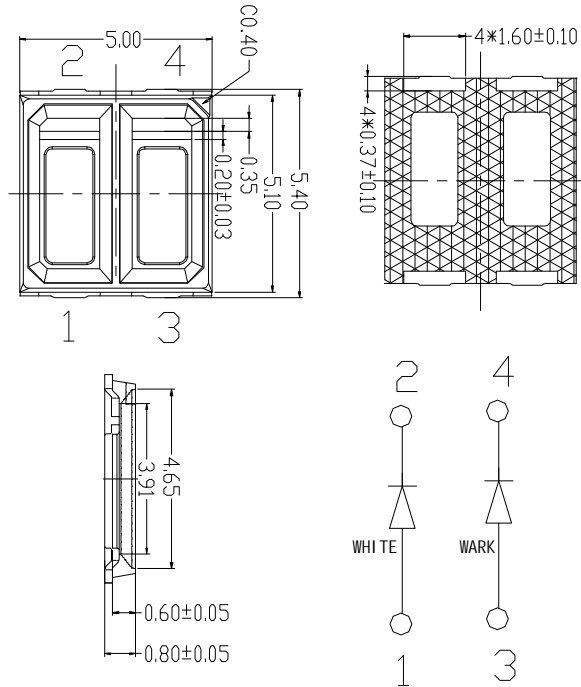

**Package Dimensions**

- Notes:
1. All dimension units are millimeters.
  2. All dimension tolerance is  $\pm 0.2$ mm unless otherwise noted.
  3. The brass column of heat sink of the high power LED is Anode. Please pay more attention to the necessary installation, when installing The heat dissipate on equipments and connecting the electric circuit in avoid of short circuit and destroying

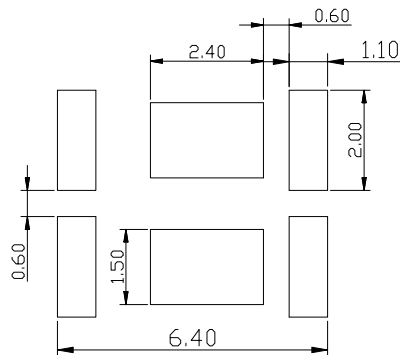
**Recommended Soldering Patter:**

## Package Adhesive Pipe (units:mm)

## Note:

- 1 LED bracket forming method: The pin of LED can be bent where is at least 2mm out of LED colloid; Finishing the forming of LED bracket must be before soldering; Guarantee the gap between two pin of LED tallys with LED pads in PCB when forming;
- 2 Manual soldering: The tip temperature of soldering iron don't exceed 300°C; soldering time don't exceed 3s and soldering position must be 3mm out of led colloid;
- 3 Static electricity and high volt can damage LED, The production whose Die material is InGaN must strictly required ESD, Must put on static glove and static fillet, soldering tool and the cover of device must connect the ground, soldering condition follows the related stating of production specification manual.
- 4 Protecting countermeasure when over current: Need add the protecting resistor in circuit in order to avoid damaging led due to big current and voltage fluctuation
- 5 LED installation method: LED can be stored for a year under the condition, the temperature of 5°C~35°C and humidity of RH60%, These production must be re-inspected and tested before use if their storage time exceed a year.
- 6 If LED is exposed in air for a week under the condition, the temperature of 5 °C ~35°C, humidity of RH60%, must place the LED in the ambience of 65°C ±5°C for 24 hours .

