

# Data Sheet

---

Customer: \_\_\_\_\_  
Part No: CL-SFC506IRR-850,660-01  
Sample No: \_\_\_\_\_  
Description: 5050 Red/IR850 SMD  
Item No: \_\_\_\_\_

Customer			
Check	Inspection	Approval	Date

**Features:**

- . Reflow Solderable
- . High Luminous Intensity and Low Power Dissipation
- . Good Reliability and Long Life
- . Complied With RoHS Directive

**Applications**

- Optical indicator
- Indoor display
- Backlighting in dashboard and switch
- Flat backlighting for LCD, symbol and display
- General use

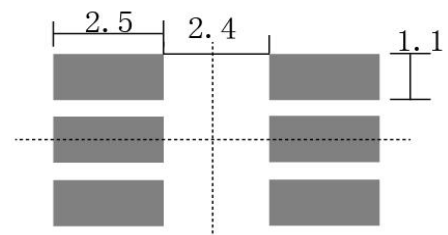
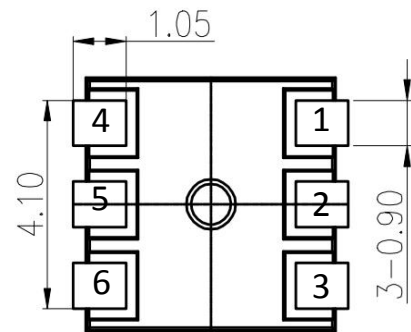
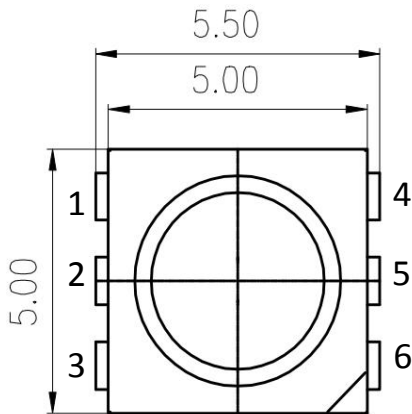
**Notes:**

- 1 . All dimension units are millimeters.
2. All dimension tolerance is  $\pm 0.2\text{mm}$  unless otherwise noted.

### Selection Guide

Part No.	Chip Materials	Lens Type	Luminous intensity(mcd) @ 1mA			Viewing Angle
			Min	Typ	Max	201/2
CL-SFC506IRR-850,660-01	(R)AlGaInP	Water Clear	10	70	--	120

Note:

1. 1/2 is the angle from optical centerline where the luminous intensity is 1/2 the optical centerline value.

2. the above luminous intensity measurement allowance tolerance  $\pm 10\%$

### Electrical / Optical Characteristics at Ta=25°C

Parameter	Symbol	Min.	Typ.	Max.	Units	test conditions
Forward Voltage	VF	1.4	--	2	V	IF=1mA
Reverse Current	IR	--	--	10	uA	VR = 5V
Dominate Wavelength	$\lambda_d$	--	660	--	nm	IF=1mA

### Absolute Maximum Ratings at Ta=25°C

Parameter	Symbol	Rating	Units
Power Dissipation	PD	40	mW
DC Forward Current	IF	20	mA
Peak Forward Current [1]	IFP	75	mA
Reverse Voltage	VR	5	V
Electrostatic Discharge (HBM)	ESD	2000	V
Operating Temperature	Topr	-40~+85	°C
Storage Temperature	Tstg	-40~+100	°C

Note:

1. 1/10 Dut cycle, 0.1ms pulse width.

2. The above forward voltage measurement allowance tolerance  $\pm 0.1V$ .

3. The tolerance of wave length:  $\pm 1nm$ .

**Selection Guide**

Part No.	Chip Materials	Lens Type
CL-SFC506IRR-850,660-01	AlGaAs/GaAs	Water clear

**Electrical And Optical Characteristics (Ta=25°C)**

Parameter	Symbol	Min	Typ.	Max	Units	Condition
Radiant Intensity	Ie	2	6	-	mW/sr	IF=20mA
Forward Voltage	VF	-	1.5	-	V	IF=20mA
Reverse Current	IR	-	-	10	uA	VR=5V
Peak Wavelength	$\lambda_p$	-	850	-	nm	IF=20mA
Controlled Angle	2 $\theta$ 1/2	-	120	-	deg	IF=20mA

Note:

1. 2 $\theta$ 1/2 is the angle from optical centerline where the luminous intensity is 2 $\theta$ 1/2 the optical centerline value.
2. the above luminous intensity measurement allowance tolerance  $\pm 10\%$

**Absolute Maximum Ratings (Ta=25°C)**

Parameter	Symbol	Ratings	Units	Notice
Continuous Forward Current	IF	50	mA	--
Power Dissipation	PD	90	mw	--
Reverse Voltage	VR	5	V	--
Operating Temperature	Topr	-20~+80	°C	--
Storage Temperature	Tstg	-40~+100	°C	--
Soldering Temperature	Tsd	260 (<10sec)	°C	--

### Typical optical characteristics curves

Ambient Temperature VS. Forward Current

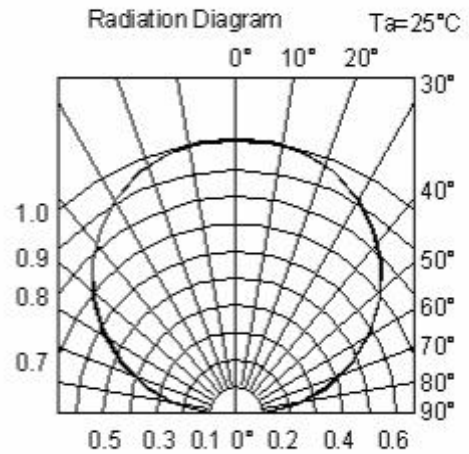
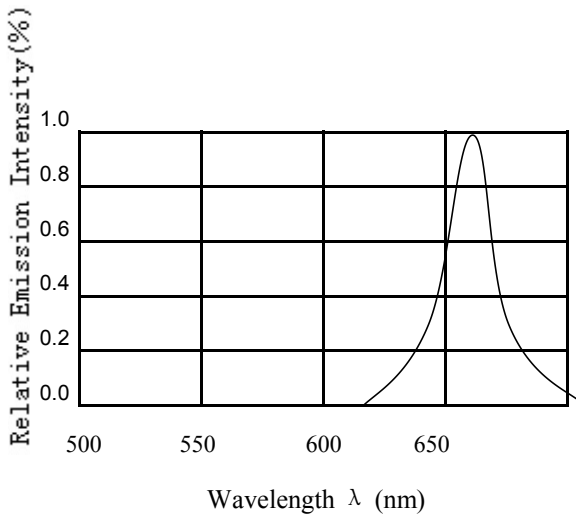
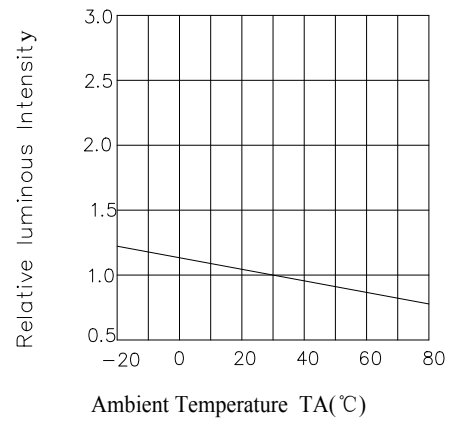
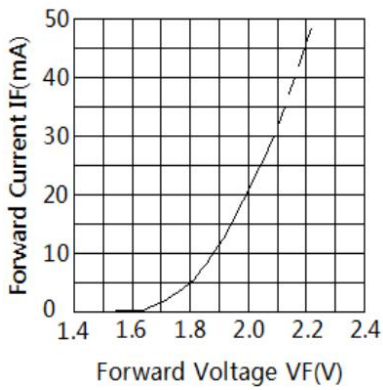
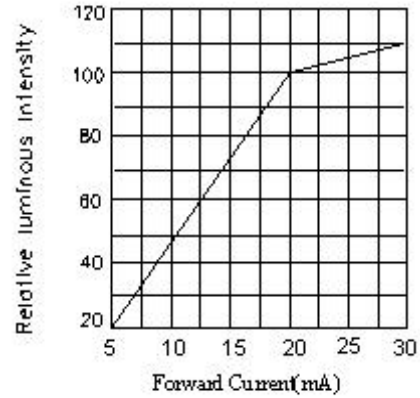
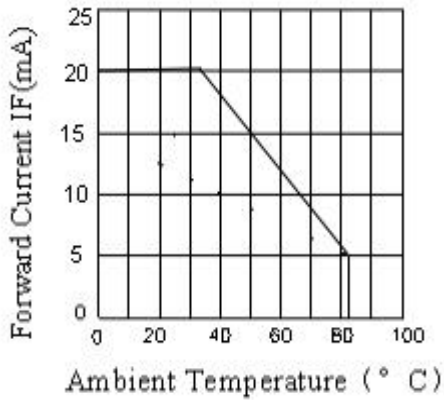

Typical Optical-Electrical Characteristic Curves

Fig.1 Forward Current Vs Forward Voltage

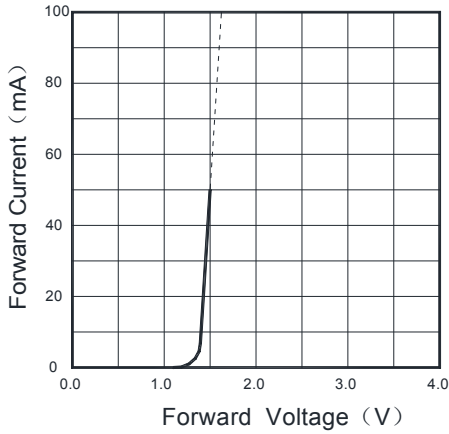

Fig.2 Relative Radiant Intensity Vs Forward Current

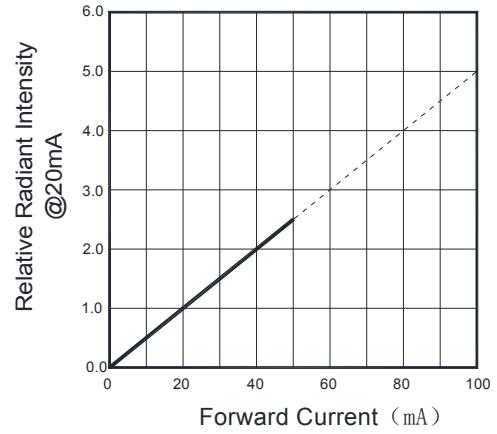

Fig.3 Relative Forward Voltage Vs Ambient Temperature

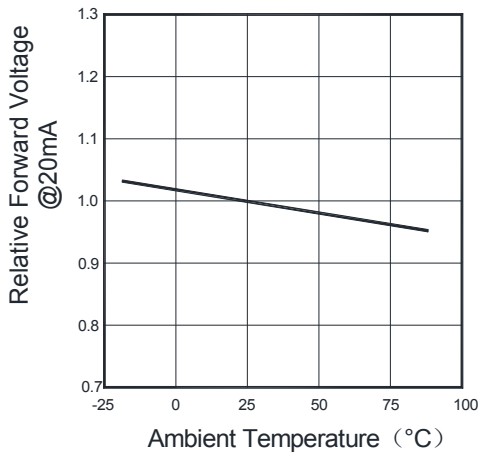

Fig.4 Relative Radiant Intensity Vs Ambient Temperature

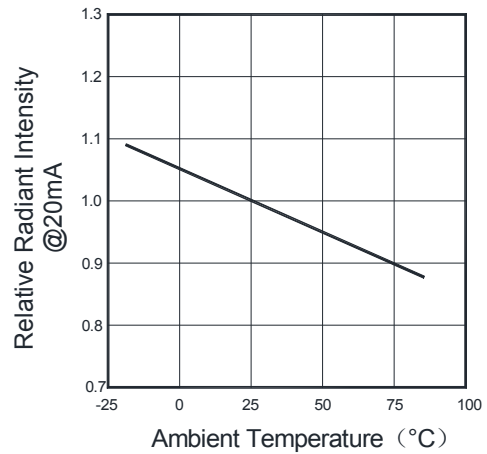

Fig.5 Spectral Distribution

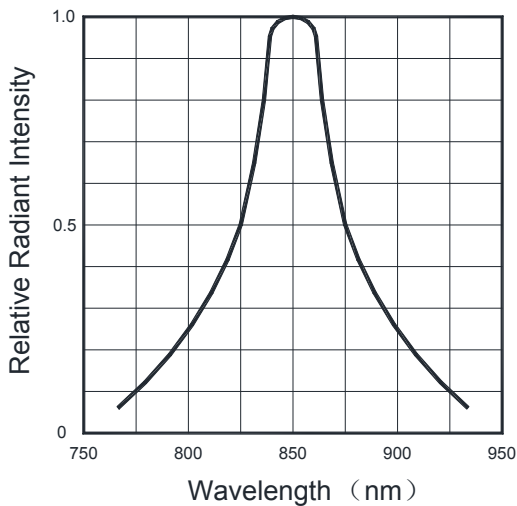
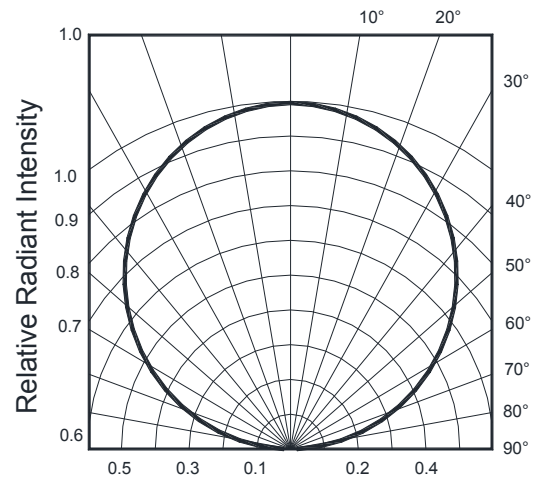

Fig.6 Radiant Diagram



### Reliability Test Items And Conditions

Test Items	Ref.Standard	Test conditions	Time	Quantity	Ac/Re
Reflow	JESD22-B106	Temp:260°C max T=10 sec	3 times.	22Pcs.	0/1
Temperature Cycle	JESD22-A104	100°C±5°C 30 min. ↑↓5 min -40°C±5°C 30 min.	100 Cycles	22Pcs.	0/1
High Temperature Storage	JESD22-A103	Temp:100°C±5°C	1000Hrs	22Pcs.	0/1
Low Temperature Storage	JESD22-A119	Temp:-40°C±5°C	1000Hrs	22Pcs.	0/1
Life Test	JESD22-A108	Ta=25°C±5°C IF=20mA	1000Hrs	22Pcs.	0/1
High Temperature High Humidity Life Test	JESD22-A101	85°C±5°C/ 85%RH	1000Hrs	22Pcs.	0/1

### Criteria For Judging Damage

Test Items	Symbol	Test conditions	Criteria For Judgement	
			Min.	Max.
Forward Voltage	VF	IF=20mA		U.S.L*)x1.1
Reverse Current	IR	VR = 5V		U.S.L*)x2.0
Luminous intensity	IV	IF=20mA	L.S.L*)x0.7	

U.S.L: Upper standard level      L.S.L: Lower standard level

The technical information shown in the data sheets are limited to the typical characteristics and circuit examples of the referenced products.It does not constitute the warranting of industrial property nor the granting of any license.

## SMT Reflow Soldering Instructions

- 1.High temperature welding recommended no more than 2 times.
2. When soldering , do not put stress on the LEDs during heating .
- 3.Reflow temperature distribution (Acc.to J-STD-020D)

Profile Feature	Sn-Pb Eutectic Assembly		Pb-Free Assembly	
	Large Body	Small Body	Large Body	Small Body
Average ramp-up rate (TL to Tp)	3 °C/second max.		3 °C/second max.	
Preheat -Temperature Min(TSmin) -Temperature Max(TSmax) -Time(min to max)(ts)	100°C 150°C 60-120 seconds		150°C 200°C 60-180 seconds	
Tsmax to TL -Ramp-up Rate			3 °C/second max.	
Time maintained above: -Temperature(TL) -Time(tL)	183°C 60-150 seconds		217°C 60-150 seconds	
Peak Temperature(Tp)	225+0/-5°C	240+0/-5°C	245+0/-5°C	260+0/-5°C
Time within 5°C of actual Peak Temperature(tp)	10-30 seconds	10-30 seconds	10-30 seconds	20-40 seconds
Ramp-down Rate	6 °C/second max.		6 °C/second max.	
Time 25°C to Peak Temperatur	6 minutes max.		8 minutes max.	

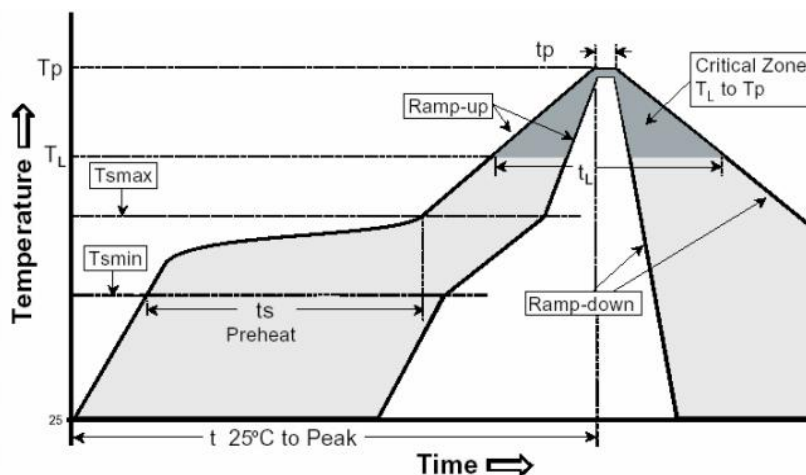

### Soldering iron

- 1.When hand soldering, the temperature of the iron must less than 350°C for 3 seconds
- 2.The hand solder should be done only one times

### Repairing

Repair should not be done after the LEDs have been soldered. When repairing is unavoidable, a double-head soldering iron should be used(as below figure). It should be confirmed in advance whether the characteristics of LEDs will or will not be damaged by repairing.

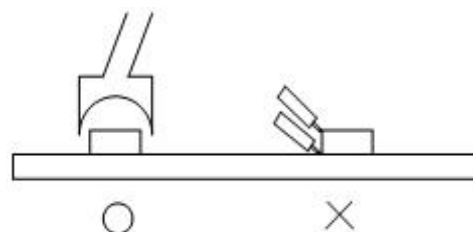



## Storage

Before the package is opened:

The storage environment shall be between 5 °C and 30 °C and the relative humidity shall be within 60 % RH. When the storage time of the product exceeds 1 year, the product must be re-baked before it can be used.

After opening the package:

1、 The ambient temperature should be kept between  $\leq 30$  ° C and relative humidity The lower 60 % RH should be maintained.

2、 If the material is not produced after more than 168 hours of exposure in the workshop, the product must be put back in the oven and dehumidified by 12H at 65 °C before it can be reused. If exposed in the workshop for more than 672 hours without production, return the material to the SMD plant for high temperature dehumidification.

3、 When the material is dehumidified, please do not open the oven in the middle, so that the oven temperature will not drop to the dehumidification effect.

## ESD

Static Electricity will damage the LED.

The following procedures may decrease the possibility of ESD damage.

- 1.All productive machinery and test instruments must be electrically grounded.
- 2.Use a conductive wrist band or anti-electrostatic glove when handling these LEDs.
- 3.Manintain a humidity level of 50%RH or higher in production areas.
- 4.Use anti-static packaging for transport and storage.

## Handling Precautions

- |   |   |                                  |
|---|---|----------------------------------|
| 1.Do not stack together assembled PCBs containing LEDs. Impact may scratch the silicone lens or damage. | 2.Not available in the situation of acidity for PH. | 3.Electrostatic sensitive device |
|---|---|----------------------------------|

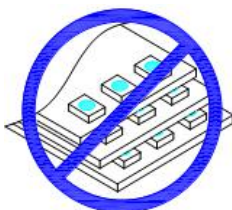

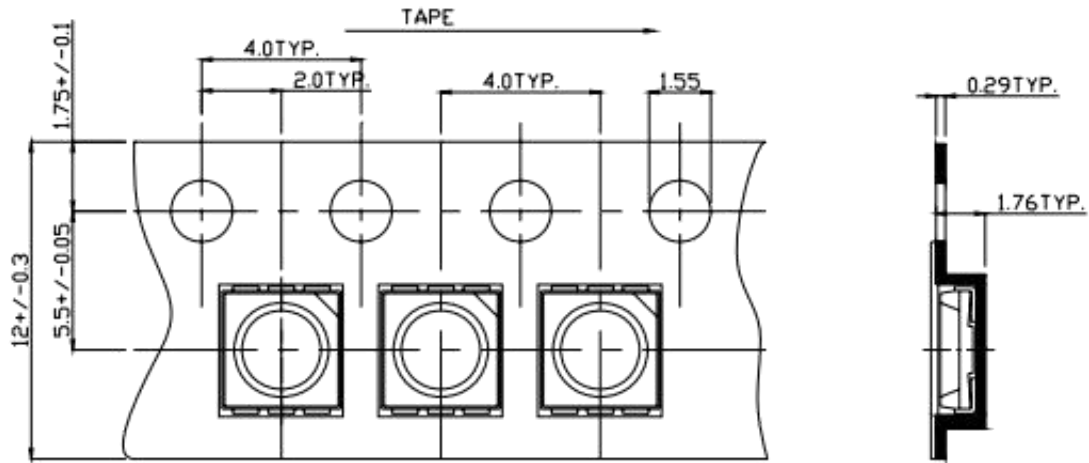
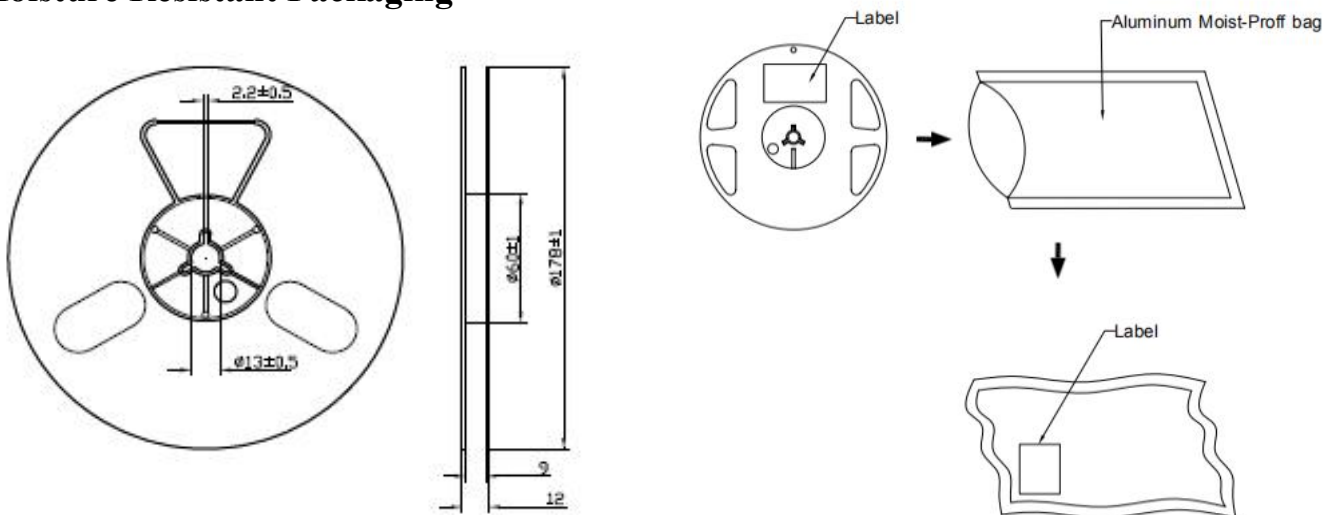
**Carrier tape: 1000PCS/reel**

**Moisture Resistant Packaging**

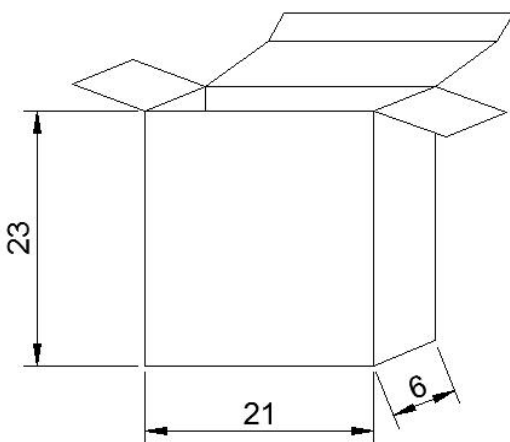
**Cardboard Box**

Maximum packing quantity (5 packs of material)



Maximum packing quantity (27 bags of material or 5 small boxes)

