

Data Sheet

Customer: _____
Part No: CL-SF685RIR-940-01
Sample No: _____
Description: 3528 Red/IR SMD
Item No: _____

| Customer | | | |
|----------|------------|----------|------|
| Check | Inspection | Approval | Date |
| | | | |

Features:

- . Reflow Solderable
- . High Luminous Intensity and Low Power Dissipation
- . Good Reliability and Long Life
- . Complied With RoHS Directive

Applications

- Optical indicator
- Indoor display
- Backlighting in dashboard and switch
- Flat backlighting for LCD, symbol and display
- General use

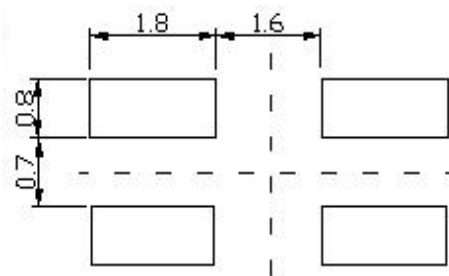
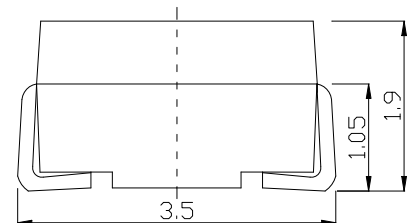
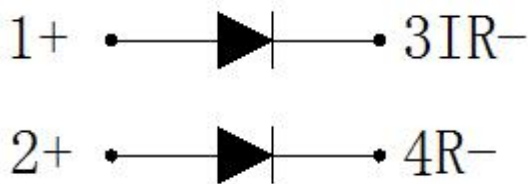
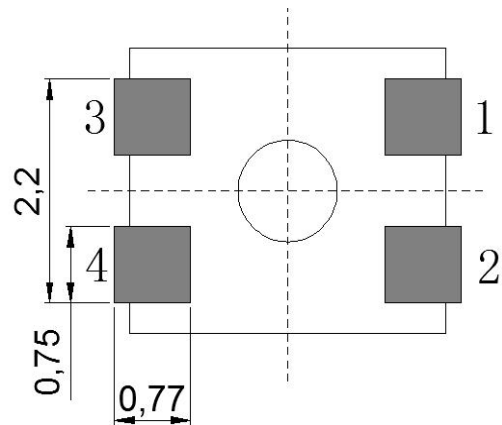
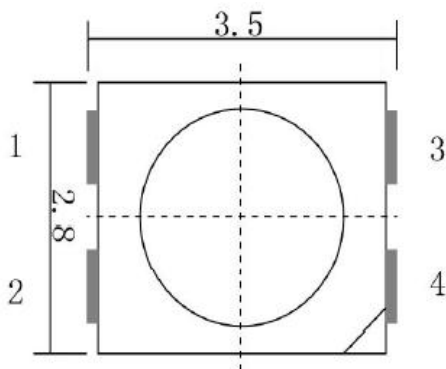

Notes:

1. All dimension units are millimeters.
2. All dimension tolerance is $\pm 0.2\text{mm}$ unless otherwise noted.

Selection Guide

| Part No. | Dice | Lens Type | Luminous intensity(mcd) @ 20mA | | | Viewing Angle |
|--------------------|------------------|-------------|--------------------------------|-----|-----|---------------|
| | | | Min | Typ | Max | 201/2 |
| CL-SF685RIR-940-01 | (R) AlGaInP | Water Clear | 120 | -- | 270 | 120 |
| | | | Radiant Intensity(mW/sr) | | | |
| | (IR) AlGaAs/GaAs | | 1 | -- | 4 | |

Note:

- 1.1/2 is the angle from optical centerline where the luminous intensity is 1/2 the optical centerline value.
- 2.the above luminous intensity measurement allowance tolerance $\pm 10\%$

Electrical / Optical Characteristics at Ta=25°C

| Parameter | Symbol | Min. | Typ. | Max. | Units | test conditions |
|---------------------|--------|------|------|------|-------|-----------------|
| Forward Voltage | R | 1.8 | -- | 2.4 | V | IF=20mA |
| | IR | 1 | -- | 1.8 | | |
| Reverse Current | IR | -- | -- | 10 | uA | VR = 5V |
| Dominate Wavelength | R | 626 | -- | 635 | nm | IF=20mA |
| | IR | -- | 940 | -- | | |

Absolute Maximum Ratings at Ta=25°C

| Parameter | Symbol | Rating | Units |
|-------------------------------|--------|----------|-------|
| Power Dissipation | R | 48 | mW |
| | IR | 36 | |
| DC Forward Current | IF | 20 | mA |
| Peak Forward Current [1] | R | 75 | mA |
| | IR | 75 | |
| Reverse Voltage | VR | 5 | V |
| Electrostatic Discharge (HBM) | ESD | 2000 | V |
| Operating Temperature | Topr | -40~+85 | °C |
| Storage Temperature | Tstg | -40~+100 | °C |

Note:

1. 1/10 Dut cycle,0.1ms pulse width.
2. The above forward voltage measurement allowance tolerance $\pm 0.1V$.
3. The tolerance of wave length: $\pm 1nm$.

Typical optical characteristics curves

Ambient Temperature VS. Forward Current

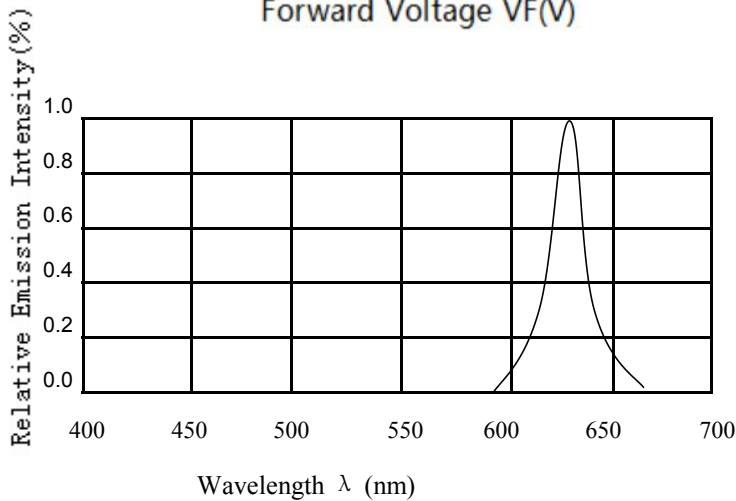
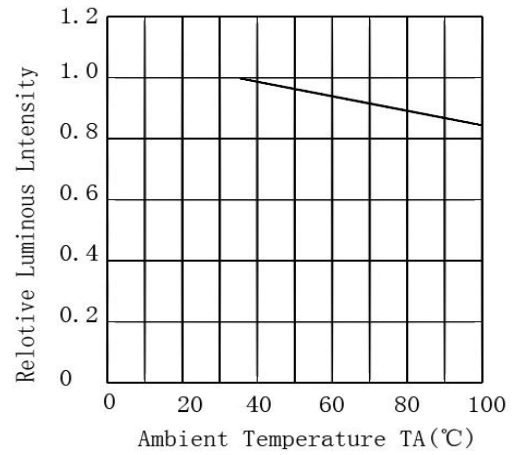
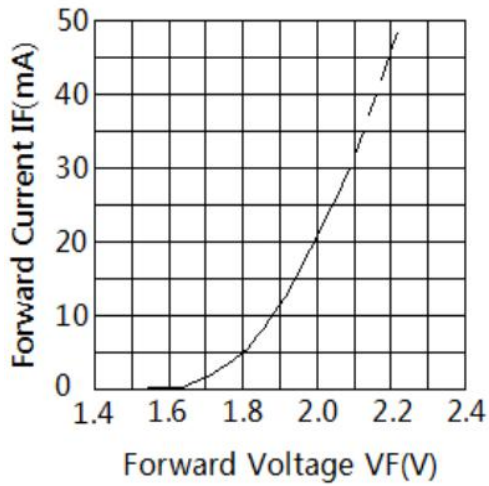
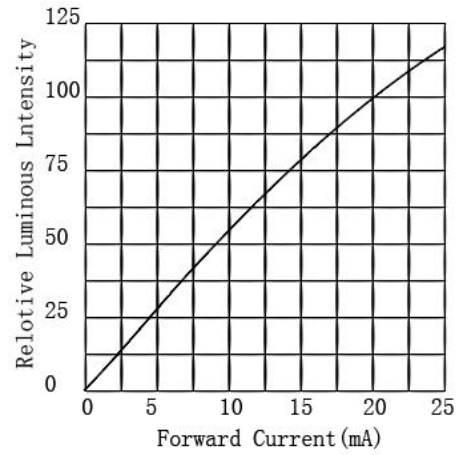
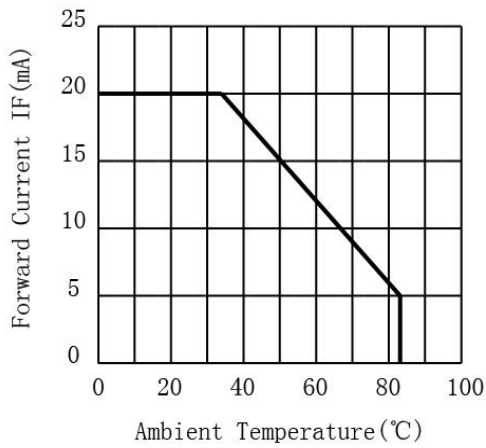

Radiation Diagram $T_a=25^\circ\text{C}$

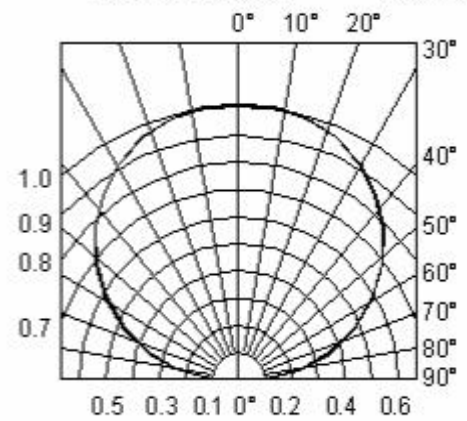

Typical Optical-Electrical Characteristic Curves

Fig.1 Forward Current Vs Forward Voltage

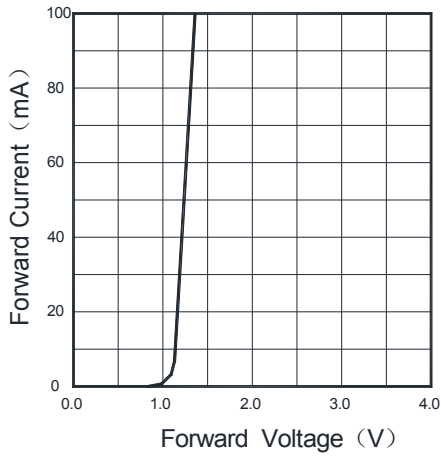

Fig.2 Relative Radiant Intensity Vs Forward Current

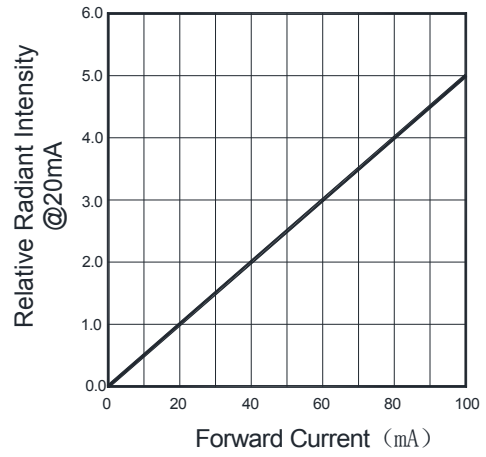

Fig.3 Relative Forward Voltage Vs Ambient Temperature

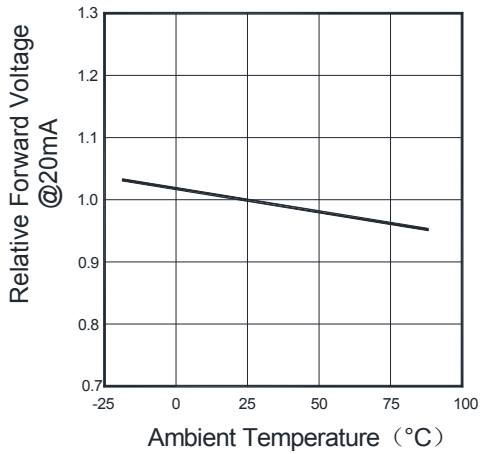

Fig.4 Relative Radiant Intensity Vs Ambient Temperature

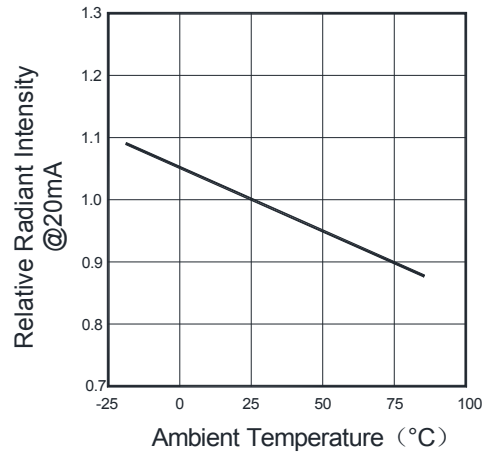

Fig.5 Spectral Distribution

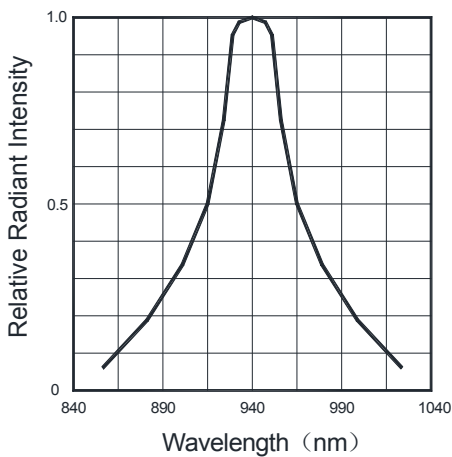
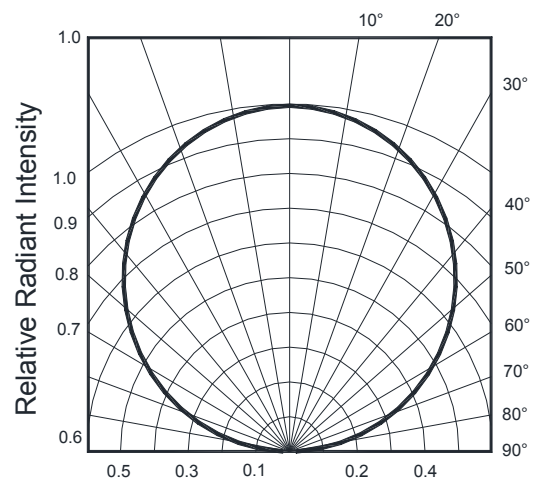

Fig.6 Radiant Diagram



Reliability Test Items And Conditions

| Test Items | Ref.Standard | Test conditions | Time | Quantity | Ac/Re |
|---|--------------|---|------------|----------|-------|
| Reflow Soldering | JESD22-B106 | Temp.:260°C±5°C Min.5sec. | 3 times. | 22Pcs. | 0/1 |
| Temperature Cycle | JESD22-A104 | 100°C±5°C 30 min. ↑↓5 min -40°C±5°C 30 min. | 100 Cycles | 22Pcs. | 0/1 |
| High Temperature Storage | JESD22-A103 | Temp:100°C±5°C | 1000Hrs | 22Pcs. | 0/1 |
| Low Temperature Storage | JESD22-A119 | Temp:-40°C±5°C | 1000Hrs | 22Pcs. | 0/1 |
| Life Test | JESD22-A108 | Ta=25°C±5°C IF=20mA | 1000Hrs | 22Pcs. | 0/1 |
| High temperature and high humidity storage experiment | JESD22-A101 | 85°C±5°C/ 85%RH | 1000Hrs | 22Pcs. | 0/1 |

Criteria For Judging Damage

| Test Items | Symbol | Test conditions | Criteria For Judgement | |
|--------------------|--------|-----------------|------------------------|-------------|
| | | | Min. | Max. |
| Forward Voltage | VF | IF=20mA | | U.S.L*)x1.1 |
| Reverse Current | IR | VR = 5V | | U.S.L*)x2.0 |
| Luminous intensity | IV | IF=20mA | L.S.L*)x0.7 | |

U.S.L: Upper standard level L.S.L: Lower standard level

The technical information shown in the data sheets are limited to the typical characteristics and circuit examples of the referenced products.It does not constitute the warranting of industrial property nor the granting of any license.

SMT Reflow Soldering Instructions

1. The number of reflow soldering shall not exceed two times, and the time from the second processing to the first completion shall not exceed 24H
2. When soldering, do not put stress on the LEDs during heating.
3. Reflow temperature distribution (Acc.to J-STD-020D)

| Profile Feature | Sn-Pb Eutectic Assembly | | Pb-Free Assembly | |
|--|----------------------------------|---------------|----------------------------------|---------------|
| | Large Body | Small Body | Large Body | Small Body |
| Average ramp-up rate (TL to Tp) | 3°C/second max. | | 3°C/second max. | |
| Preheat -Temperature Min(TSmin) -Temperature Max(TSmax) -Time(min to max)(ts) | 100°C 150°C 60-120 seconds | | 150°C 200°C 60-180 seconds | |
| Tsmax to TL -Ramp-up Rate | | | 3°C/second max. | |
| Time maintained above: -Temperature(TL) -Time(tL) | 183°C 60-150 seconds | | 217°C 60-150 seconds | |
| Peak Temperature(Tp) | 225+0/-5°C | 240+0/-5°C | 245+0/-5°C | 260+0/-5°C |
| Time within 5°C of actual Peak Temperature(tp) | 10-30 seconds | 10-30 seconds | 10-30 seconds | 20-40 seconds |
| Ramp-down Rate | 6°C/second max. | | 6°C/second max. | |
| Time 25°C to Peak Temperatur | 6 minutes max. | | 8 minutes max. | |

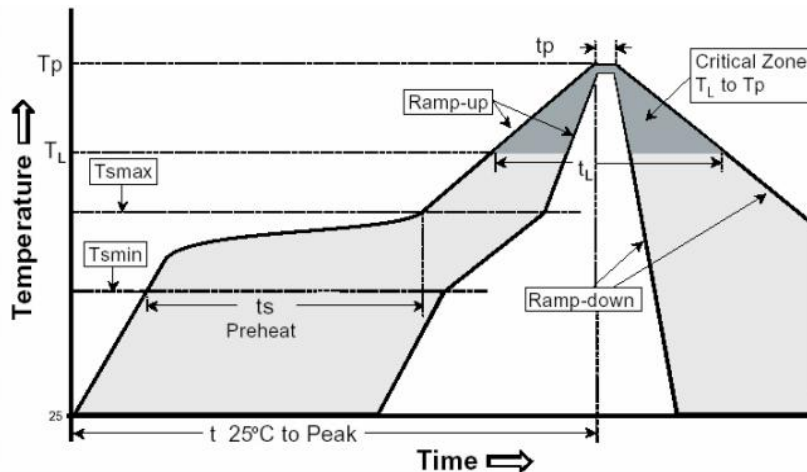

Soldering iron

1. When hand soldering, the temperature of the iron must be less than 350°C for 3 seconds
2. The hand solder should be done only one time

Repairing

Repair should not be done after the LEDs have been soldered. When repairing is unavoidable, a double-head soldering iron should be used (as shown in the figure below). It should be confirmed in advance whether the characteristics of LEDs will or will not be damaged by repairing.

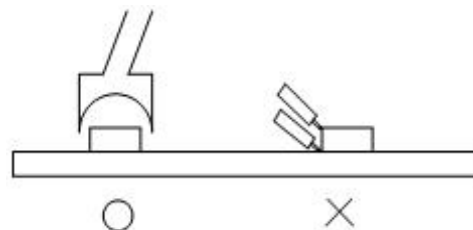

Storage

This product uses sealing anti-moisture antistatic packaging, and with desiccant, humidity card.

Before packaging is opened:

1、 Storage environment: the ambient temperature should be kept between 5°C and 30°C, and the relative humidity should be kept within 60% RH. When the storage time of the product exceeds 3 months, it must be dehumidified before use. The dehumidification condition is: 65°C/24H.

2、 Please check that the package is leaking before opening. If it has leaked, please re-bake and use it or return to the plant to dehumidify.

After opening the package:

1、 After opening the package, check whether the humidity card has a discoloration phenomenon. For example, 20 % of the humidity card indicates discoloration. Please remove the material from the bag and use it after dehumidifying 24H at 65 °C.

2、 Environmental conditions: The ambient temperature should be kept between $\leq 30^{\circ} \text{C}$ and relative humidity The lower 60 % RH should be maintained.

3、 if the material is not produced after exposure in the workshop for more than 24 hours, the product must be put back in the oven, dehumidified with 65 °C 24H, and then can be used again. If the material is not produced after 48 hours of exposure in the workshop, return the material to the SMD plant for high temperature dehumidification.

4、 When the material is dehumidified, please do not open the oven in the middle, so that the oven temperature will not drop to the dehumidification effect.

Please refer to the following operating methods when the material needs to be dehumidified



Correct way: material desiccant need to remove the bag, use the way of hanging baked



Wrong way: the material is dehumidified without removing the bag, in a stacking manner

ESD

Static Electricity will damage the LED.

The following steps can reduce the likelihood of ESD causing product damage

- 1.All productive machinery and test instruments must be electrically grounded.
- 2.Use a conductive wrist band or anti-electrostatic glove when handling these LEDs.
- 3.Maintain a humidity level of 50%RH or higher in production areas.
- 4.Use anti-static packaging for transport and storage.

Handling Precautions

- 1.Do not stack the assembled PCB together. This may scratch the surface of the product or damage the circuit.

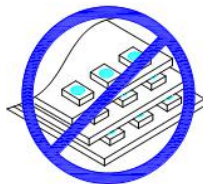

2. Not available in the situation of acidity for PH.



3. Electrostatic sensitive device



Carrier tape: 2000PCS/reel

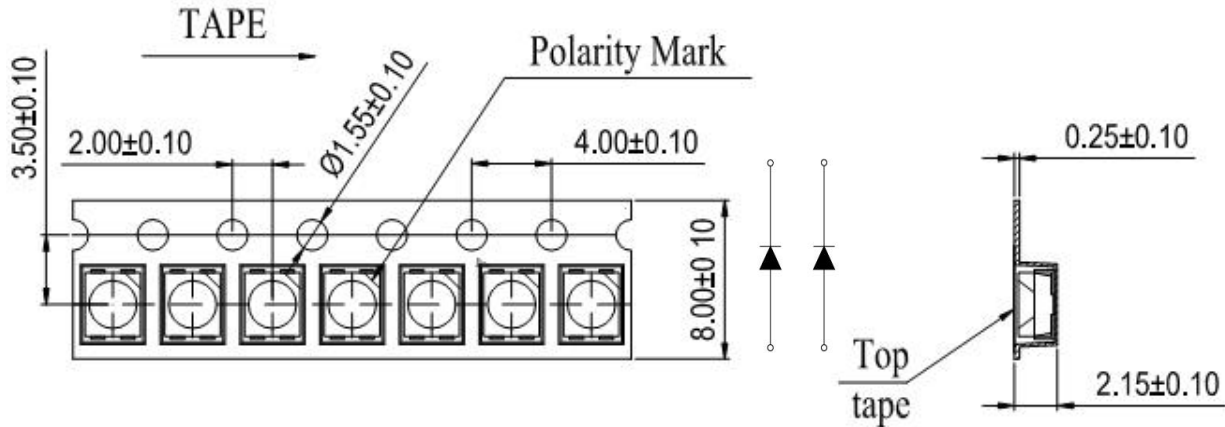

Moisture Resistant Packaging

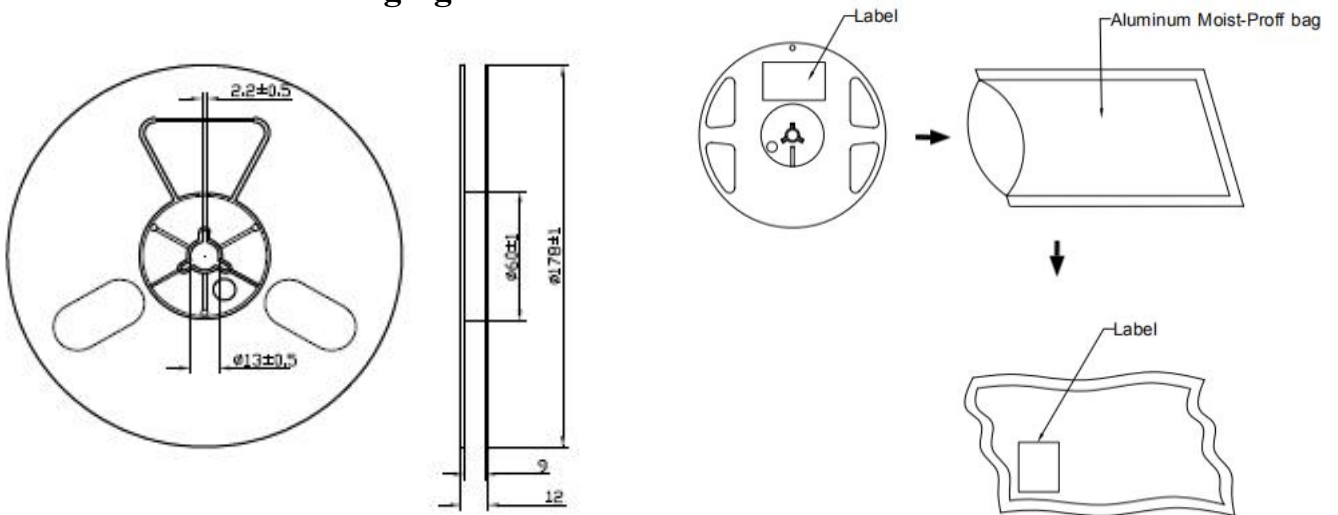

Cardboard Box

Maximum packing quantity (5 packs of material)

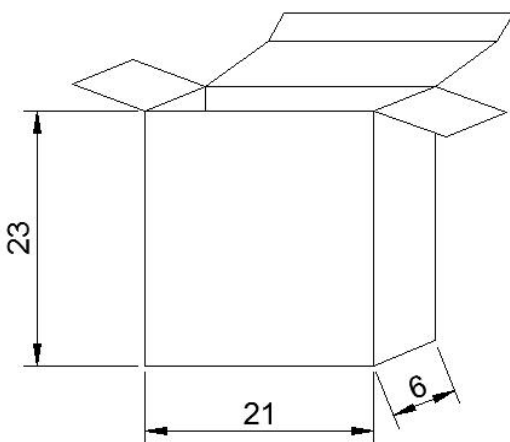

Maximum packing quantity (27 bags of material or 5 small boxes)

