



Data Sheet

Customer: _____

Part No: _____

CL-BIT2012DBW-6.5K-02(5mA)

Sample No: _____

Description: _____

2012 SMD White Color

Item No: _____

Customer			
Check	Inspection	Approval	Date

Features

- _2.0mmX1.25mm SMT LED, 1.10mm THICKNESS.
- _LOW POWER CONSUMPTION.
- _WIDE VIEWING ANGLE.
- _IDEAL FOR BACKLIGHT AND INDICATOR.
- _VARIOUS COLORS AND LENS TYPES AVAILABLE.
- _PACKAGE: 3000PCS / REEL.
- _RoHS COMPLIANT.

Description

The Yellow source color devices are made with Gallium Arsenide Phosphide on Gallium Phosphide Yellow Light

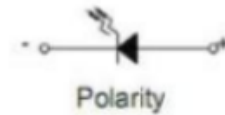
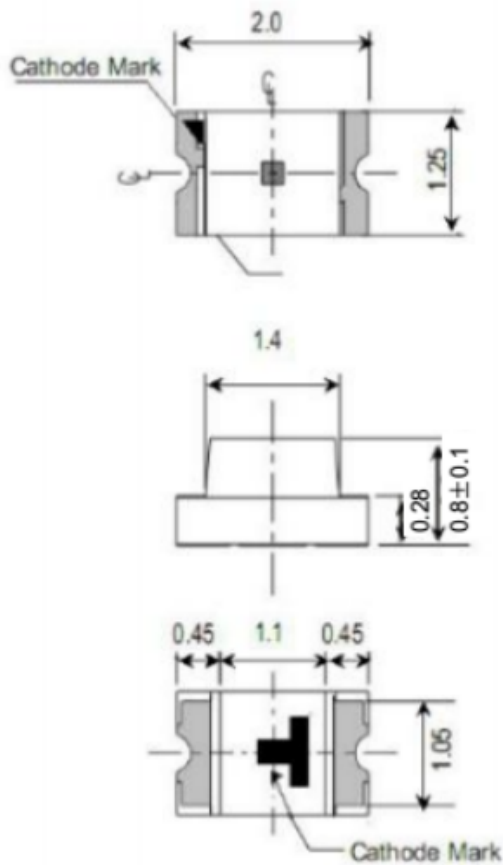
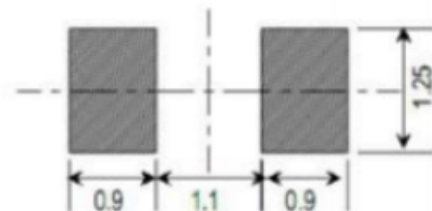
Package Dimensions

Recommended Solder Pad

Notes:

1. All dimensions are in millimeters (inches).
2. Tolerance is ± 0.1 (0.004") unless otherwise noted.
3. Specifications are subject to change without notice.

Selection Guide

Part No.	Dice	Lens Type	Iv (mcd) @ 5 mA		Viewing Angle
			Min.	MAX.	2 θ 1/2
CL-BIT2012DBW-6.5K-02(5mA)	White (GaN)	Yellow Diffused	150	262	120

Note:

1. θ1/2 is the angle from optical centerline where the luminous intensity is 1/2 the optical centerline value.

Electrical / Optical Characteristics at TA=25°C

Symbol	Parameter	Device	Typ.	Max.	Units	Test Conditions
λD	Dominant Wavelength	White	5500	7500	K	IF= 5 mA
Δλ1/2	Spectral Line Half-width	White			nm	IF= 5 mA
C	Capacitance	White			pF	VF=0V;f=1MHz
VF	Forward Voltage	White	2.6	3.1	V	IF= 5 mA
IR	Reverse Current	White		2	uA	VR = 7V

Remarks:

If special sorting is required (e.g. binning based on forward voltage, luminous intensity, or wavelength), the typical accuracy of the sorting process is as follows:

1. Wavelength: +/-1nm
2. Luminous Intensity: +/-15%
3. Forward Voltage: +/-0.1V

Note: Accuracy may depend on the sorting parameters

Absolute Maximum Ratings at TA=25°C

Parameter	White	Units
Power dissipation	135	mW
DC Forward Current	30	mA
Peak Forward Current [1]	140	mA
Reverse Voltage	5	V
Operating/Storage Temperature	-40°C To +85°C	

Note:

1. 1/10 Duty Cycle, 0.1ms Pulse Width.

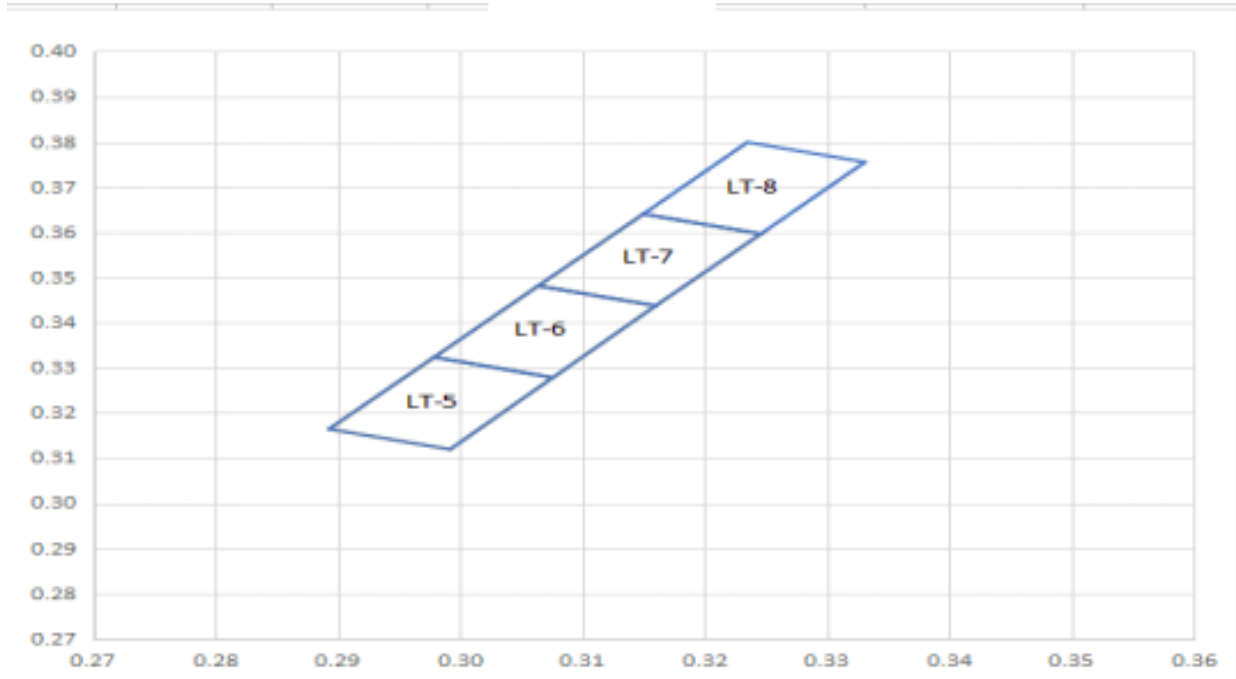

LT-5	0.2893	0.3164	LT-7	0.3064	0.3481
	0.2992	0.3119		0.3160	0.3437
	0.3076	0.3278		0.3246	0.3596
	0.2979	0.3323		0.315	0.364
LT-6	0.2979	0.3323	LT-8	0.315	0.364
	0.3076	0.3278		0.3246	0.3596
	0.3160	0.3437		0.3331	0.3755
	0.3064	0.3481		0.3235	0.3799

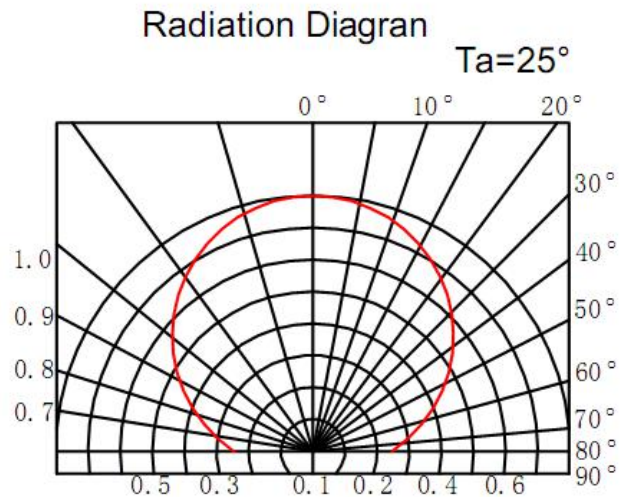
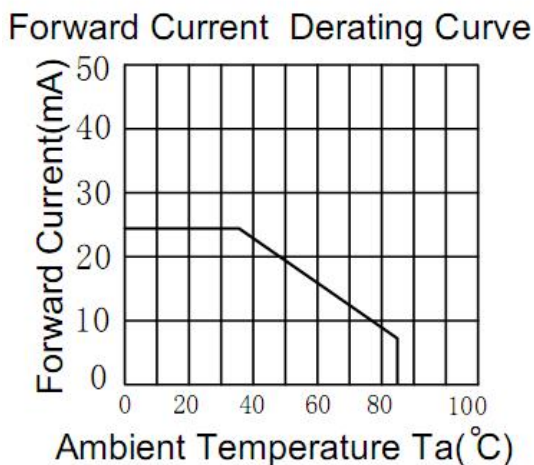
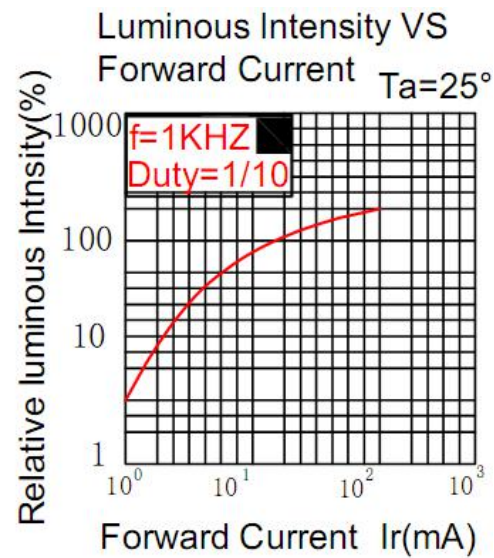
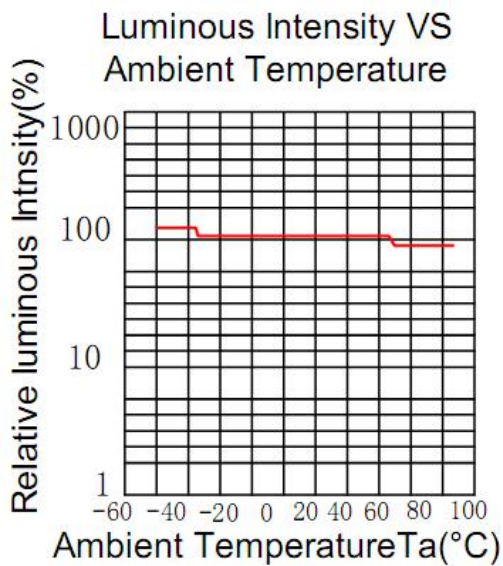
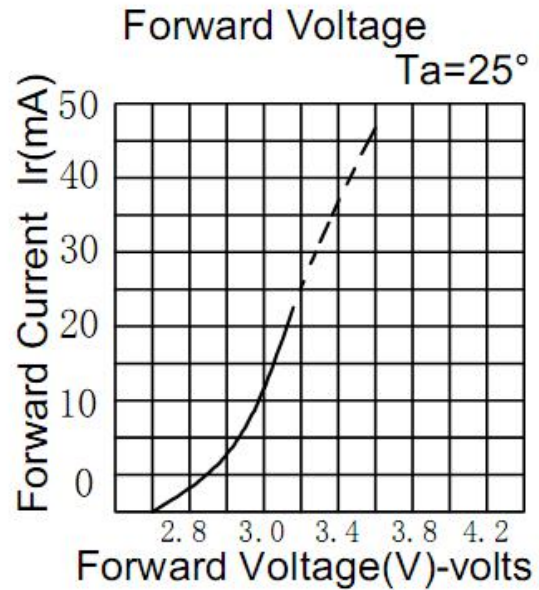
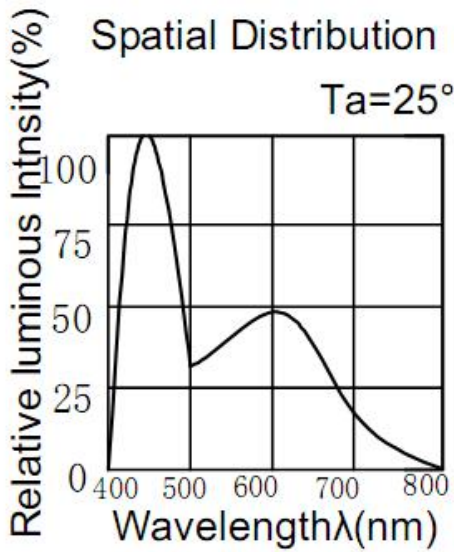

4. RELIABILITY

(1) Test Items and Results

NO.	Test Item	Reference Standard	Test Conditions	(Hours/Cycles)	Sample	Number of Damaged
1	Temperature Cycle	JEITA ED-4701	-40 °C - 25 °C - 100 °C - 25 °C 30min 5min 30min 5min	100 Cycles	50	0/50
2	Thermal shock	MIL-STD-202G	-40°C ~ 100°C 15min 15min	500 Cycles	50	0/50
3	High Temperature Storage	JEITA ED-4701 200 201	Ta=100°C	1000 Hours	50	0/50
4	Low Temperature Storage	JEITA ED-4701 200 201	Ta=-40°C	1000 Hours	50	0/50
5	Room Temperature Life Test		Ta=25±5°C IF=20mA	1000 Hours	50	0/50
6	High Temperature High Humidity Life Test		Ta=60°C RH=85% IF=20mA	1000 Hours	50	0/50
7	Solderability (Reflow Soldering)	JEITA ED-4701 300 303	Tsol=235°C ± 5°C, 5sec (Using Flux, Lead Solder)	1 time, 5sec	10	0/10
8	Resistance to Soldering Heat (Reflow Soldering)	JEITA ED-4701 300 301	Tsol=250°C, 10 sec Pre Treatment: 35 °C 95% RH96 Hrs	2 time, 10sec	10	0/10

The above test items such as differences or special customer specific requirements according to the actual situation in accordance with the requirements of customers to try the requirements with the customer, the customer is not required by our test standard test. Different products using different current test

5. Cautions

(1) Soldering Conditions

Number of reflow process shall be less than 2 times and cooling process to normal temperature is required between first and Second soldering process.

(Recommended soldering conditions)

(Lead Solder)

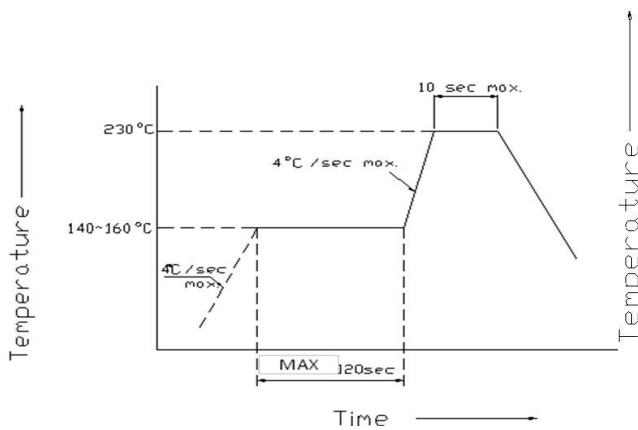

(Lead-Free Solder)

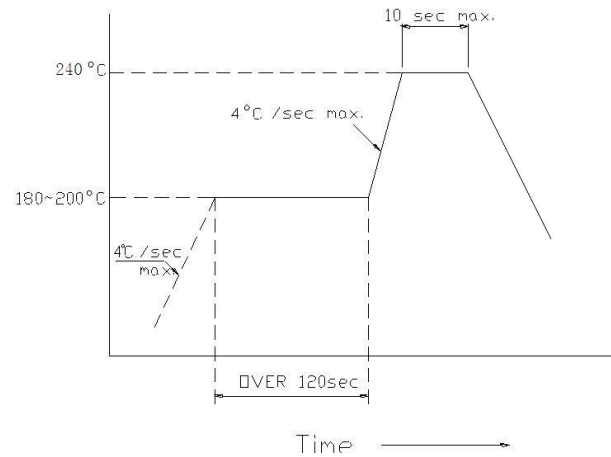

(2) Static Electricity

It is recommended that a wrist band or an anti-electrostatic glove be used when handling the LEDs.

All devices, equipment and machinery must be properly grounded.

2.0V Damaged LEDs will show some unusual characteristics such as the forward voltage becomes lower, or the LEDs do not light at the low current. Criteria : ($V_F > 2.0V$ at $I_F=0.5mA$)

(3) Moisture Proof Package

It is recommended that moisture proof package be used .

(4)Cautions:

4.1. Please check if there is air leak before opening the package, if so, please return the goods back to take drying process for later using.

4.2 Products can be used within 15days after packaging, after that, they must be:

4.2.1 Soldered within 24 hrs

4.2.2 Used in the condition: $30^{\circ}C$ within and 60%RH below

4.2.3 Stored in 30%RH for moisture below.

4.3.Products cannot be used for and over 15days after being packaged unless opening the package and take drying our process in $85^{\circ}C/6H$.

4.4.Products not be used for or over 60days after being packaged please return back to take drying out and packaging process for forward using.

4.5.Products not be used after opening the package need to be dried out for $85^{\circ}C/6H$

PACKAGING

The LEDs are packed in cardboard boxes after taping.

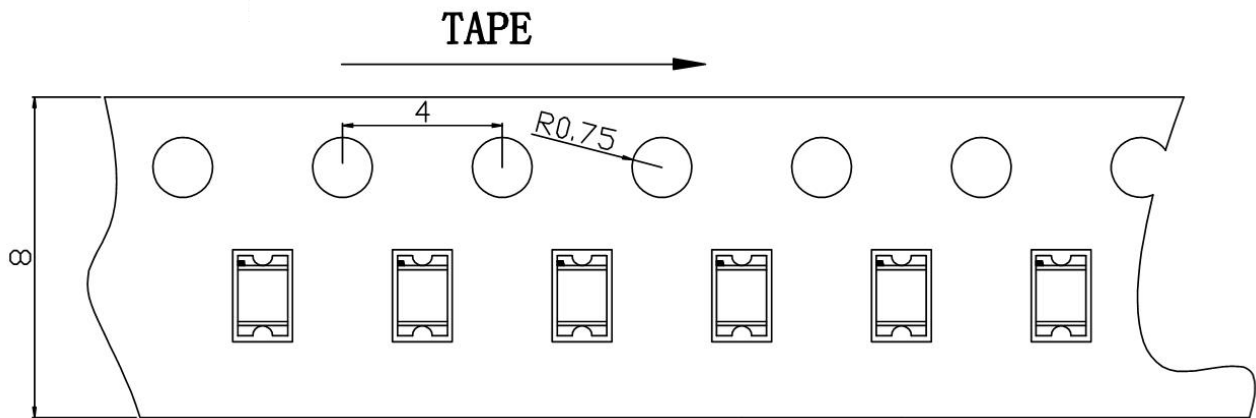

Package: 4000 pcs/reel

Reel Dimensions

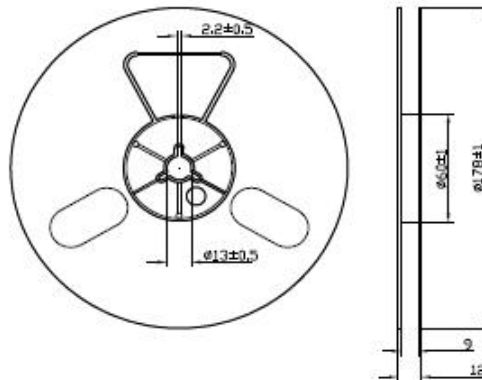

Moisture Resistant Packaging

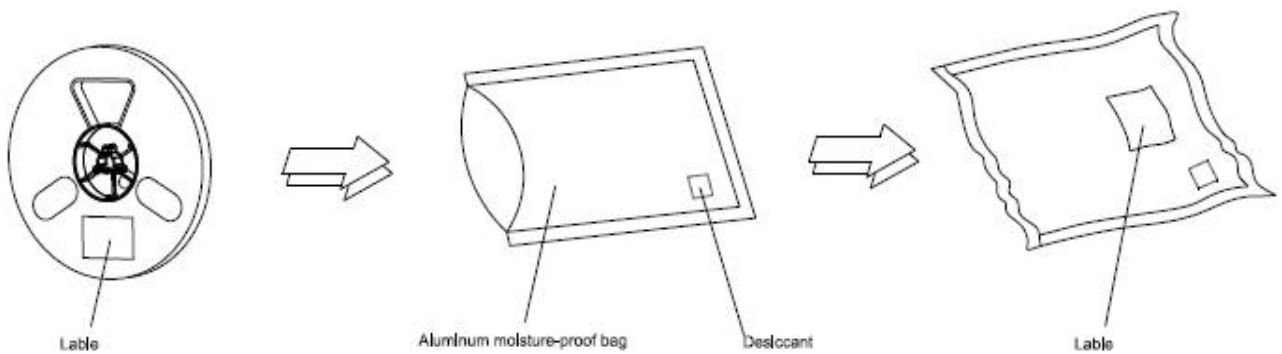

Note: The tolerances unless mentioned is $\pm 0.1\text{mm}$, Unit: mm