



**CIEL LIGHT CO.,LTD.**

**PRODUCT SPECIFICATION**

Customer: \_\_\_\_\_

Customer's Model No.: \_\_\_\_\_

Customer's Drawing No.: \_\_\_\_\_

Model No.: CL-5019URPGW1A-001-CC

Drawing No.: \_\_\_\_\_

**Features**

- Low power consumption
- High Efficiency
- Round type
- T1 ( 5mm ) diameter
- With Flange
- Solder leads without stand-off
- Compliant with RoHS

**Descriptions**

- Chip Material: AlGaInP/GaAs InGaN/GaN
- Emitting Color: Red 、 Green
- Lens Color: White Diffused

**ATTENTION**



OBSERVE PRECAUTIONS  
FOR HANDLING  
ELECTROSTATIC  
SENSITIVE DEVICES

**Outline Drawing**

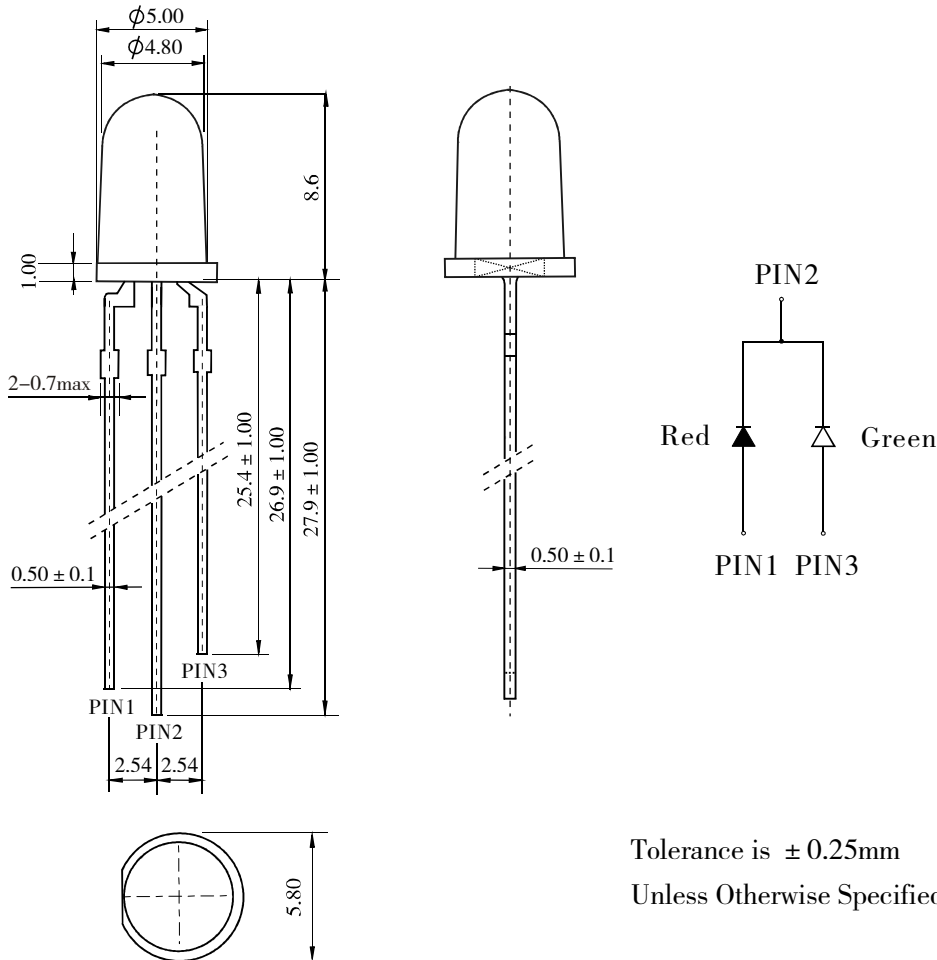

Tolerance is  $\pm 0.25\text{mm}$   
Unless Otherwise Specified.

Electrical Optical Characteristics ( Ta=25°C )

Parameter	Symbol	Red			Unit	Test Condition
		Min	Typ	Max		
Forward Voltage	$V_F$	---	2.0	2.4	V	IF=20mA
Luminous Intensity	$I_V$	280	550	---	mcd	IF=20mA
Peak Wavelength	$\lambda_P$	---	632	---	nm	IF=20mA
Dominant Wavelength	$\lambda_d$	---	624	---	nm	IF=20mA
Spectral Line half-width	$\Delta \lambda$	---	20	---	nm	IF=20mA
Reverse Leakage Current	$I_R$	---	---	50	$\mu A$	VR=5V
Viewing Angle	$2\theta_{1/2}$	---	60	---	Deg	IF=20mA

Absolute Maximum Parameters ( Ta=25°C )

Parameter	Symbol	Condition	Rating	Unit
Power Dissipation	$P_D$	---	80	mW
Reverse Voltage	$V_R$	---	5	V
Forward Average Current	$I_F$	---	30	mA
Temperature coefficient	I/C	---	0.33	mA/ °C
Pulse Current	IFP	Duty=1/10,1kHz	100	mA
Operating Temperature Range	$T_{opr}$	---	-25 ~ +85	°C
Storage Temperature Range	$T_{stg}$	---	-30 ~ +100	°C
Soldering Condition	$T_{sd}$	---	260°C/5sec	°C

NOTE:

Luminous Intensity Measurement allowance is  $\pm 10\%$ .

$2\theta_{1/2}$  is the off-axis angle at which the luminous intensity is half the axial luminous intensity.

The dominant wavelength is derived from the CIE chromaticity diagram and represents the single wavelength which defines the color of the device.

Typical Electro-Optical Characteristic Curves ( Ta=25°C )

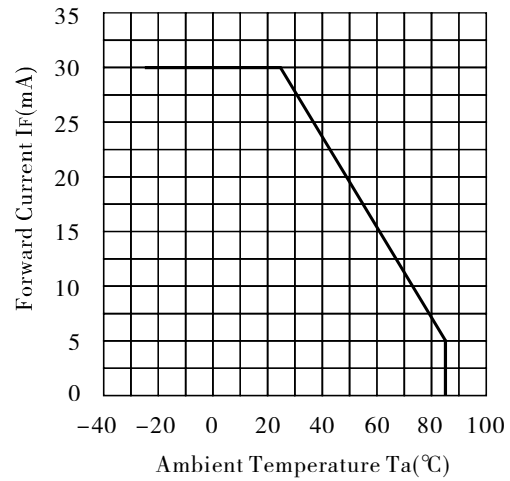
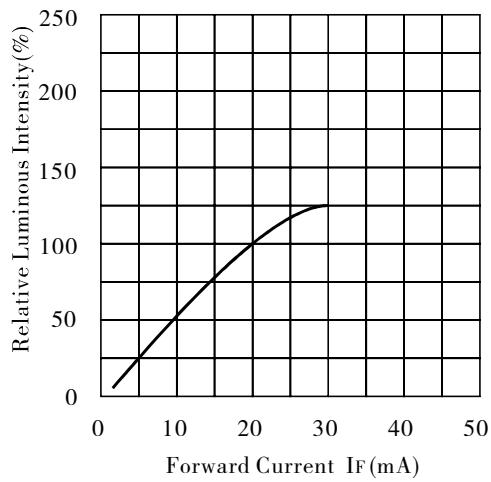
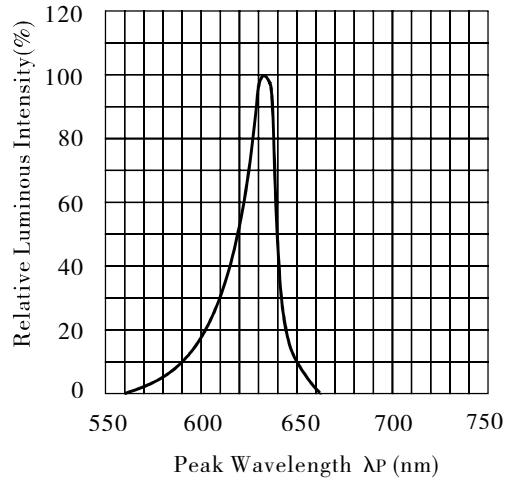
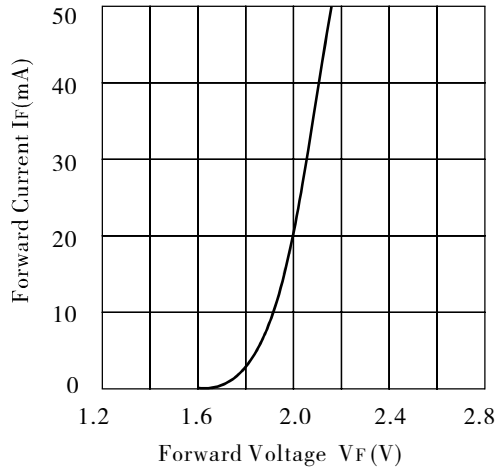

Directive Characteristics

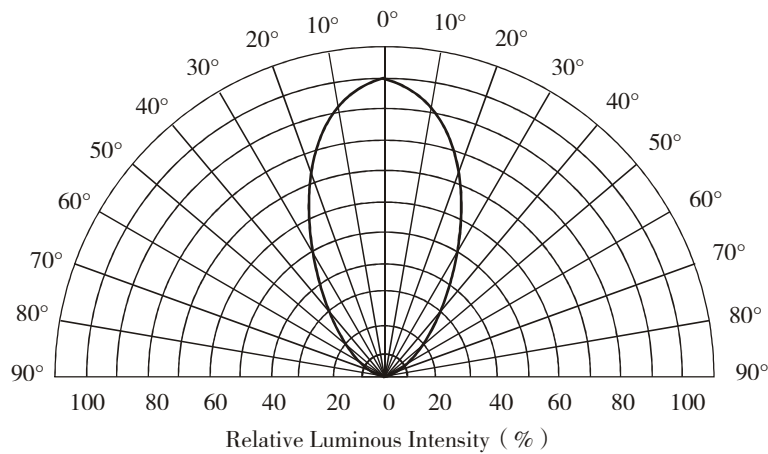

Electrical Optical Characteristics ( Ta=25°C )

Parameter	Symbol	Green			Unit	Test Condition
		Min	Typ	Max		
Forward Voltage	$V_F$	---	3.2	3.6	V	IF=20mA
Luminous Intensity	$I_V$	550	1100	---	mcd	IF=20mA
Peak Wavelength	$\lambda_P$	---	525	---	nm	IF=20mA
Dominant Wavelength	$\lambda_d$	---	520	---	nm	IF=20mA
Spectral Line half-width	$\Delta \lambda$	---	30	---	nm	IF=20mA
Reverse Leakage Current	$I_R$	---	---	50	$\mu A$	VR=5V
Viewing Angle	$2\theta_{1/2}$	---	60	---	Deg	IF=20mA

Absolute Maximum Parameters ( Ta=25°C )

Parameter	Symbol	Condition	Rating	Unit
Power Dissipation	$P_D$	---	120	mW
Reverse Voltage	$V_R$	---	5	V
Forward Average Current	$I_F$	---	30	mA
Temperature coefficient	I/C	---	0.4	mA/ °C
Pulse Current	IFP	Duty=1/10,1kHz	100	mA
Operating Temperature Range	$T_{opr}$	---	-25 ~ +85	°C
Storage Temperature Range	$T_{stg}$	---	-30 ~ +100	°C
Soldering Condition	$T_{sd}$	---	260°C/5sec	°C

NOTE:

Luminous Intensity Measurement allowance is  $\pm 10\%$ .

$2\theta_{1/2}$  is the off-axis angle at which the luminous intensity is half the axial luminous intensity.

The dominant wavelength is derived from the CIE chromaticity diagram and represents the single wavelength which defines the color of the device.

Typical Electro-Optical Characteristic Curves ( Ta=25°C )

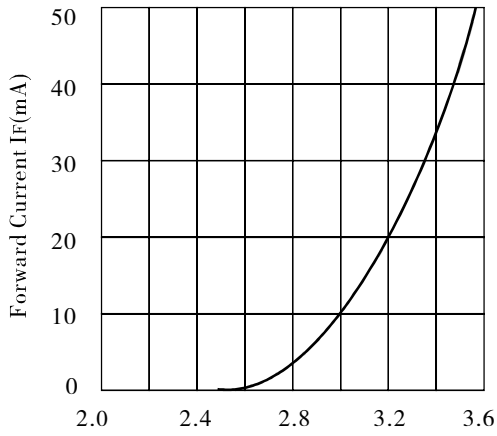

Forward Voltage  $V_F$  (V)

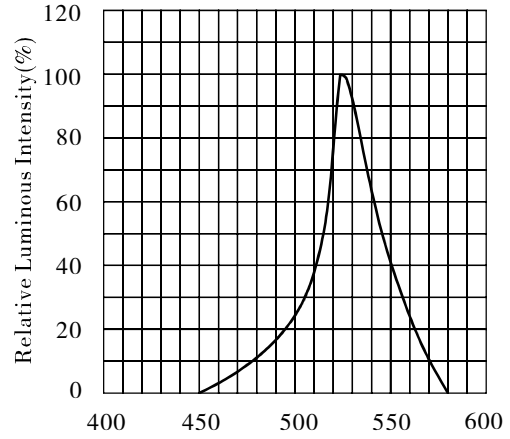

Peak Wavelength  $\lambda_P$  (nm)

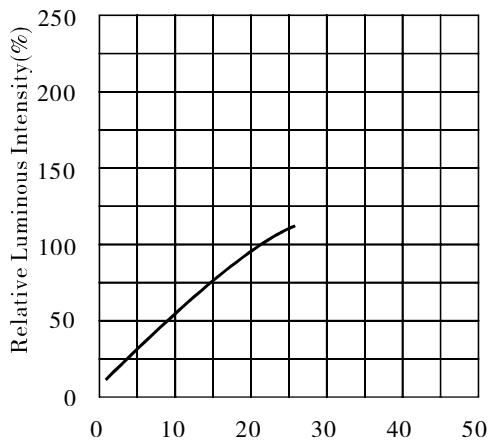

Forward Current  $I_F$  (mA)

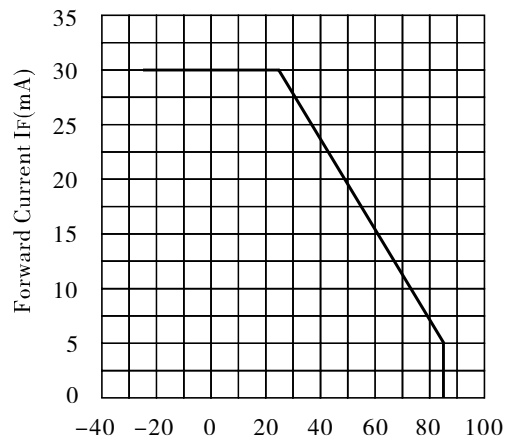

Ambient Temperature  $T_a$  (°C)

Directive Characteristics

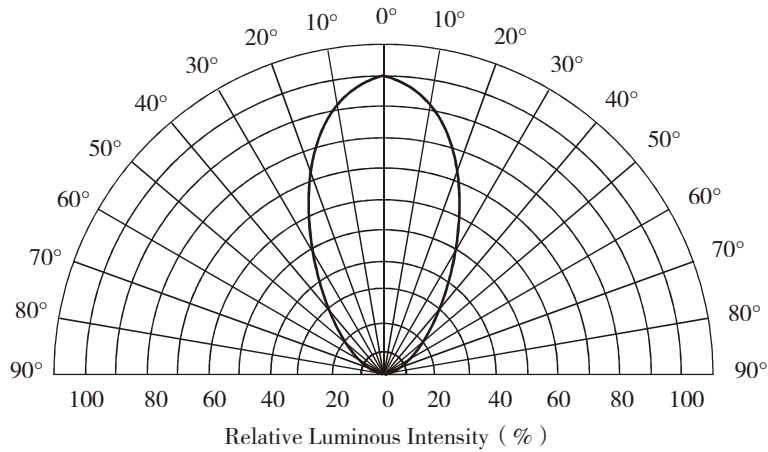

Reliability Test Conditions

Test Item	Test Condition	Result	Judgment Criteria
Consecutive operating life test	IF=20mA, T=25℃, t=168h	0/100	Forward Voltage $VF(V) = \text{Upper Limit} \times 1.2$ Reverse Leakage Current $IR(\mu A) = \text{Upper Limit} \times 2.0$ Luminous Intensity IV $(mcd) = \text{Lower Limit} \times 0.7$
High temperature storage life test	T=100℃, t=168h	0/100	
Low temperature storage life test	T=25℃, t=168h	0/100	
High temperature humidity storage life test	T=85 ± 2℃, RH=85% ± 3, t=168h	0/100	
Temperature cycle test	-25℃~25℃~100℃ 30min 5min 30min 10cycles	0/100	
Thermal shock test	100℃ 0℃ 5min 5min 20cycles	0/100	
Soldering heat test	T=260 ± 5℃, t=10s ± 1s	0/100	
Solderability test	T=235 ± 5℃, t=5s ± 0.5s	0/100	Steeped Part ≥ 95%
Fall test	h=100cm, 50times	0/100	Intact
Terminal strength test	W=9.8N, t=30 ± 5s	0/100	
Lead bending test	W=4.9N, 2times	0/100	