



CIEL LIGHT CO.,LTD.

PRODUCT SPECIFICATION

Model No.: CLA-3220RGW-10T

Drawing No.: _____

Customer: _____

Customer's Model No.: _____

Customer's Drawing No.: _____

Descriptions

1. Emitting color: White Mini LED, Pure Green, Red
2. Lens color: White Diffused
3. Surface black color : Black 0.175PET
4. Dice material: InGaN/GaN AlGaInP/GaAs

Outline drawing

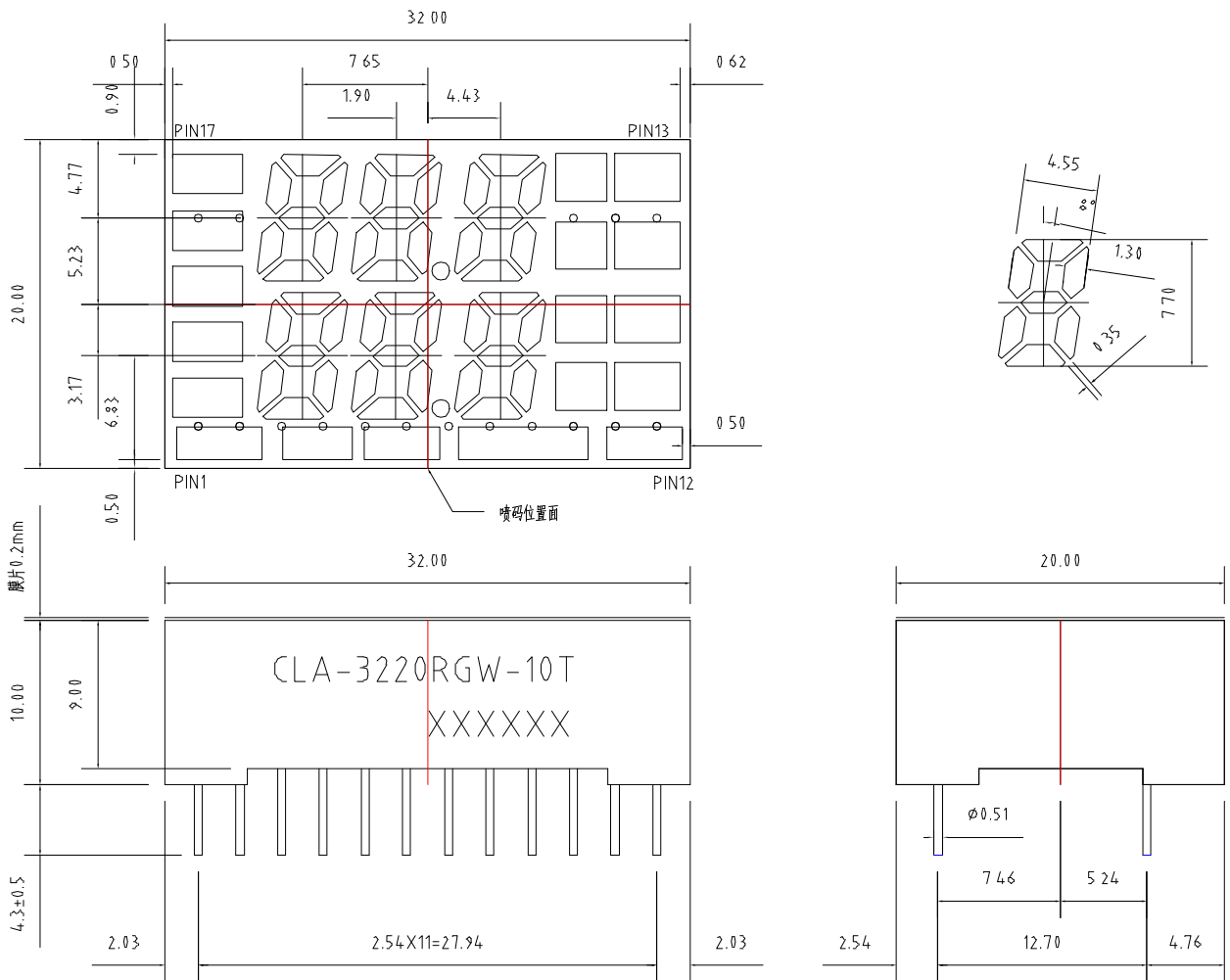

Tolerance is ± 0.25 mm unless otherwise noted

Internal Circuit Diagram (Common Cathode)

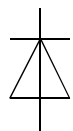
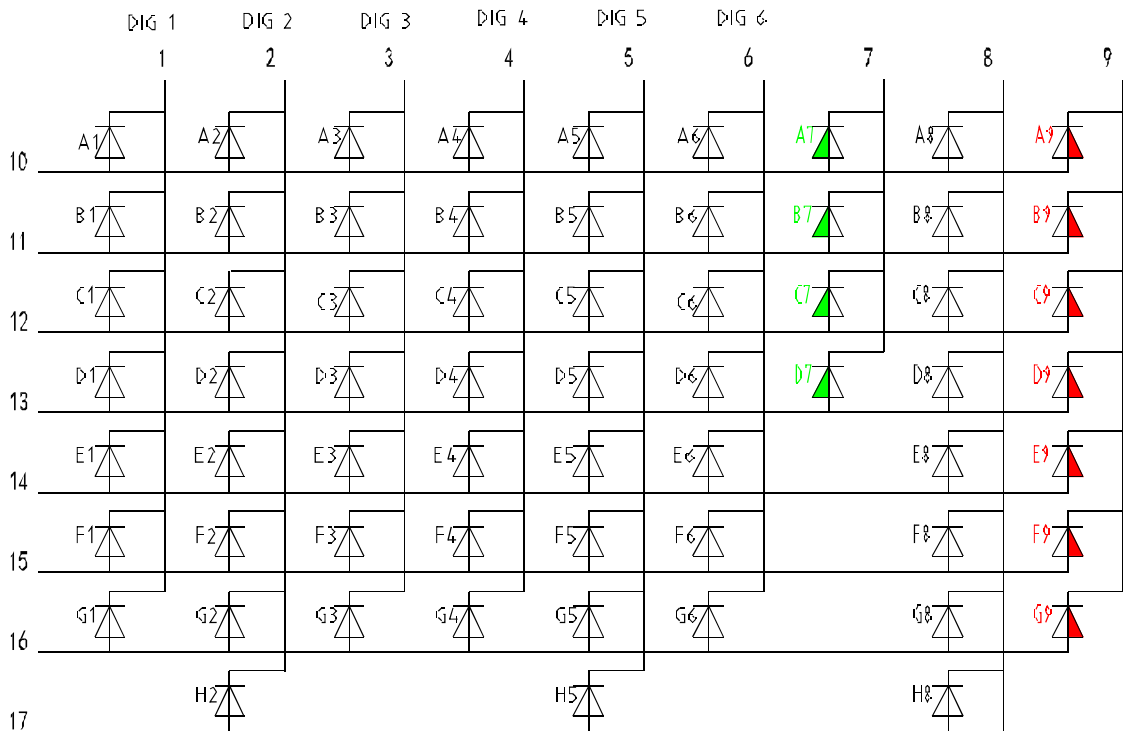
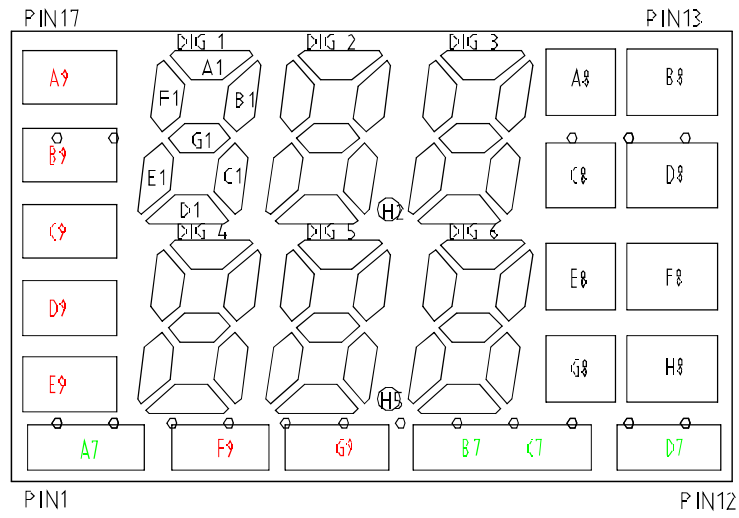

WHITE

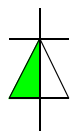

PG

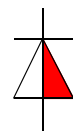

RED

Film Drawing

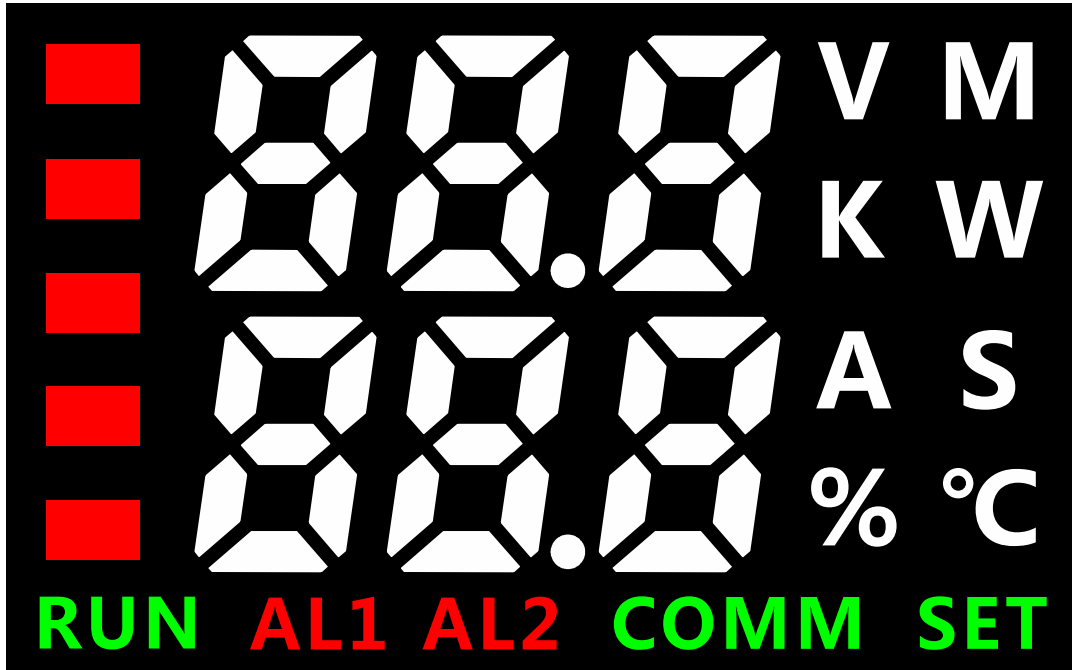

Electrical optical characteristics (Ta=25°C)

Parameter	Symbol	White			Unit	Test Condition
		Min	Typ	Max		
Forward Voltage	V _F	2.8	---	3.6	V	IF=20mA
Luminous Intensity	I _V	26.6	102	---	med	IF=20mA
Chromaticity Coordinates	X	---	0.28	---	---	IF=20mA
	Y	---	0.27	---		
Reverse Leakage Current	I _R	---	---	50	μA	V _R =5V

Absolute maximum parameters (Ta=25°C)

Parameter	Symbol	Condition	Rating	Unit
Power Dissipation	PD	---	90	mW
Reverse Voltage	V _R	---	5	V
Forward Average Current	IF	---	25	mA
Temperature coefficient	I/C	---	0.33	mA/°C
Pulse Current	IFP	Duty=1/10,1kHz	60	mA
Operating Temperature Range	T _{opr}	---	-25 ~ +85	°C
Storage Temperature Range	T _{stg}	---	-30 ~ +100	°C
Soldering Condition	T _{sd}	---	265°C/5sec	°C

Typical Electro-Optical characteristic curves (Ta=25°C)

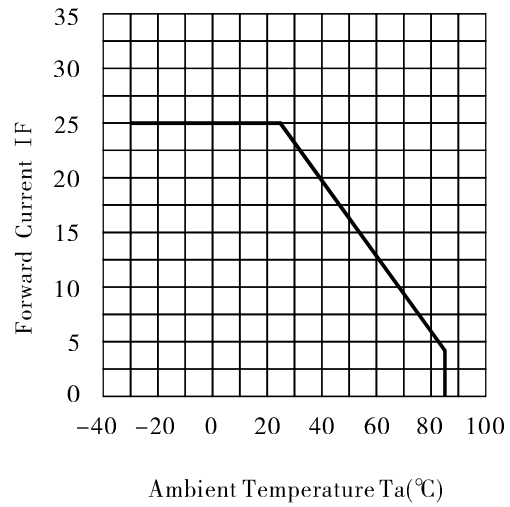
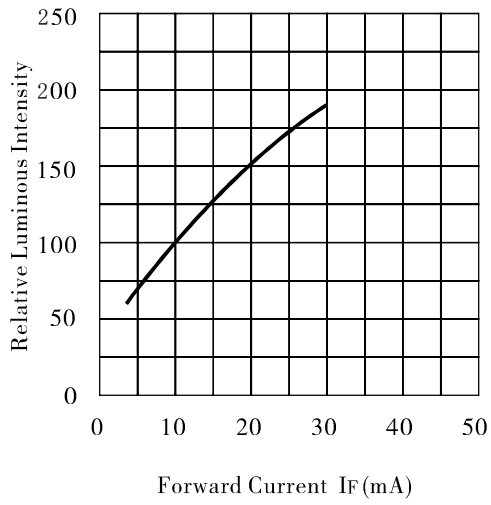
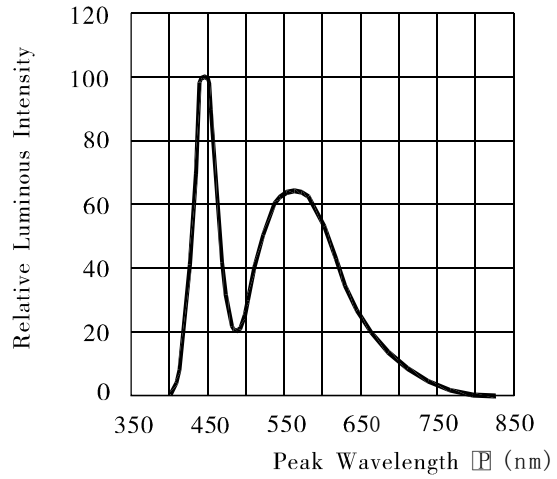
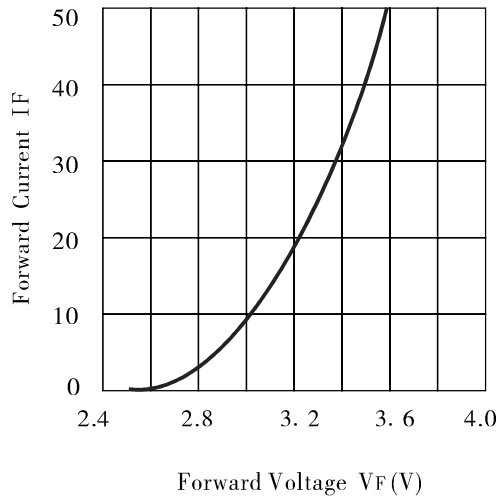

Electrical And Optical Characteristics (Ta=25°C)

Parameter	Symbol	Pure Green			Unit	Test Condition
		Min	Typ	Max		
Forward Voltage	V _F	2.8	3.2	3.6	V	IF=20mA
Luminous Intensity	I _V	52.0	102	---	med	IF=20mA
Peak Wavelength	λ _P	---	---	---	nm	IF=20mA
Dominant Wavelength	λ _d	---	523	---	nm	IF=20mA
Spectral Line half-width	Δλ	---	30	---	nm	IF=20mA
Reverse Leakage Current	I _R	---	---	50	μA	V _R =5V

Absolute Maximum Parameters (Ta=25°C)

Parameter	Symbol	Test Condition	Rating	Unit
Power Dissipation	P _D	---	90	mW
Reverse Voltage	V _R	---	5	V
Forward Average Current	I _F	---	25	mA
Temperature Coefficient	I/C	---	0.33	mA/°C
Pulse Current	I _{FP}	Duty=1/10,1kHz	100	mA
Operating Temperature Range	T _{opr}	---	-25 ~ +85	°C
Storage Temperature Range	T _{stg}	---	-30 ~ +100	°C
Soldering Temperature	T _{sd}	---	260°C/5sec	°C

Typical Electrical/Optical Characteristic Curves (Ta=25°C)

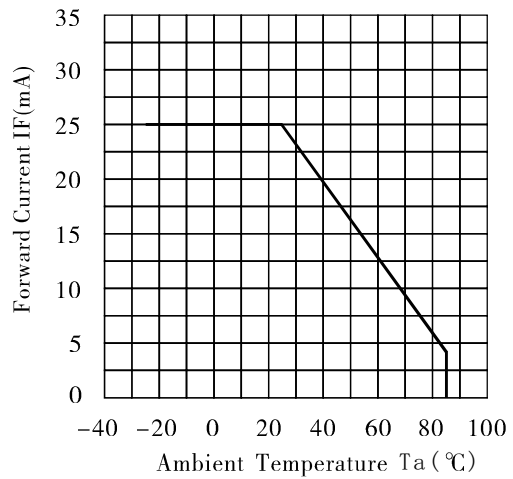
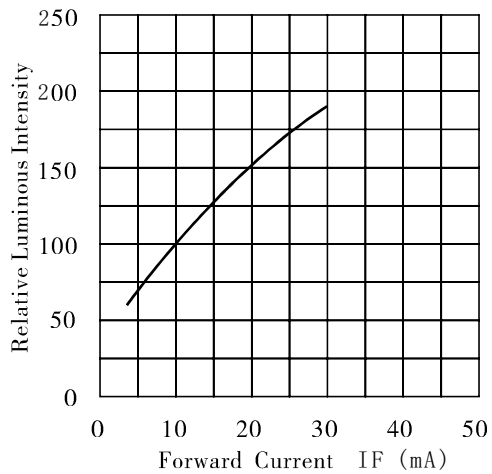
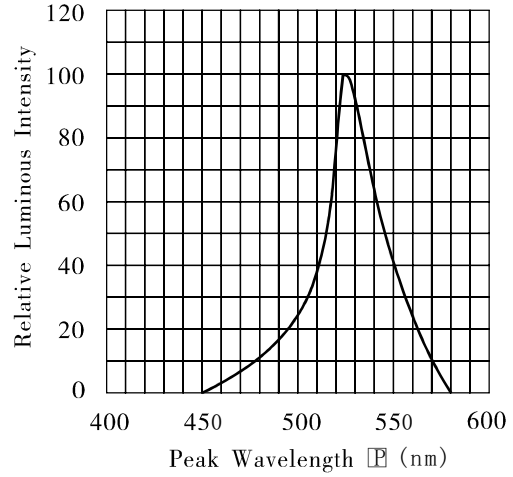
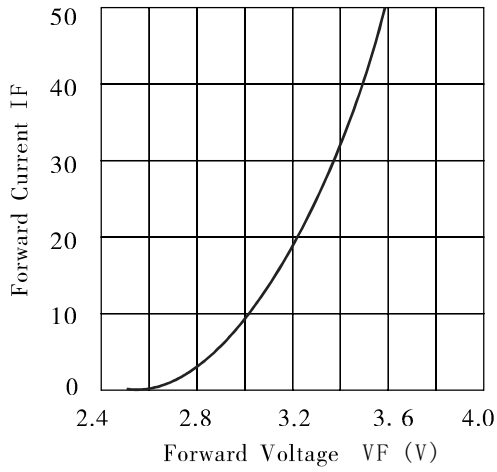

Electrical optical characteristics (Ta=25°C)

Parameter	Symbol	Ultra Red			Unit	Test Condition
		Min	Typ	Max		
Forward Voltage	V_F	---	2.00	2.40	V	IF=20mA
Luminous Intensity	I_v	19.0	37.2	---	mcd	IF=20mA
Peak Wavelength	λ_P	---	633	---	nm	IF=20mA
Dominant Wavelength	λ_d	---	624	---	nm	IF=20mA
Spectral Line half-width	$\Delta\lambda$	---	20	---	nm	IF=20mA
Reverse Leakage Current	I_R	---	---	50	μA	VR=5V

Absolute Maximum Parameters(Ta=25°C)

Parameter	Symbol	Condition	Rating	Unit
Power Dissipation	P_D	---	60	mW
Reverse Voltage	V_R	---	5	V
Forward Average Current	I_F	---	25	mA
Temperature Coefficient	I/C	---	0.33	mA/°C
Pulse Current	IFP	Duty=1/10,1kHz	100	mA
Operating Temperature Range	Topr	---	-25 ~ +85	°C
Storage Temperature Range	Tstg	---	-30 ~ +100	°C
Soldering Condition	Tsd	---	260°C/5sec	°C

Typical Electro-Optical characteristic curves (Ta=25°C)

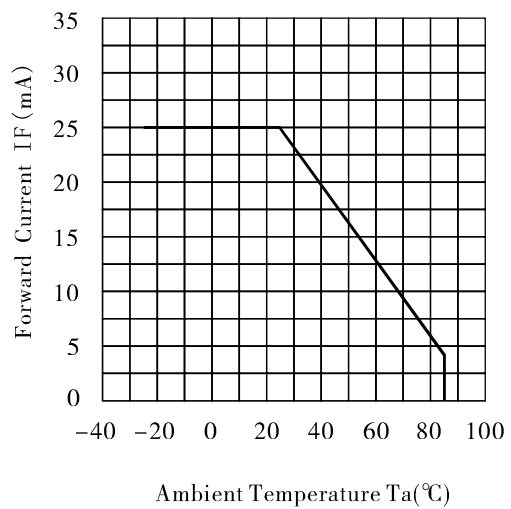
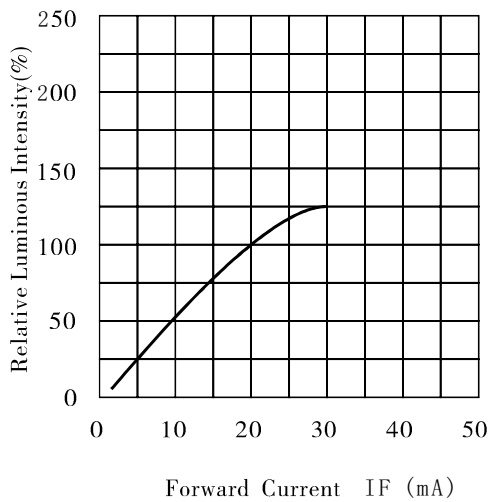
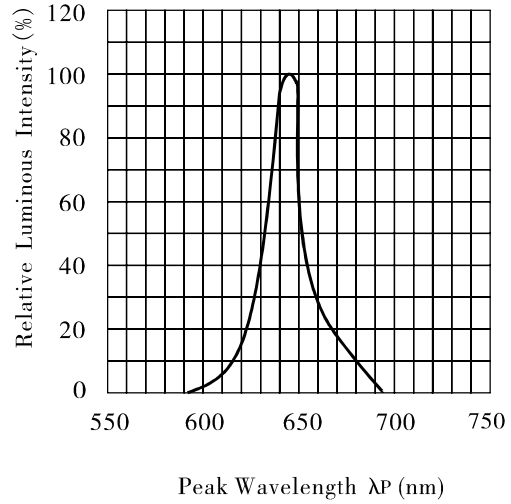
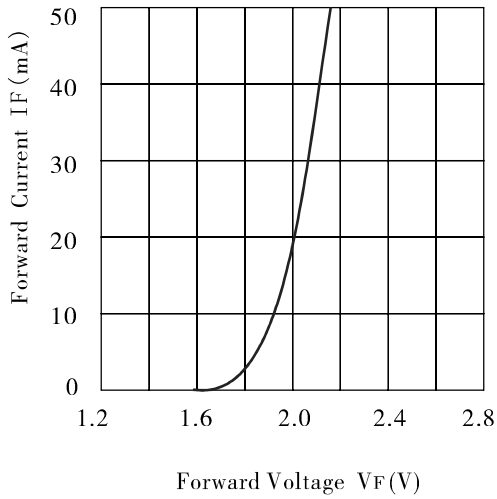

Reliability test conditions

Test Item	Test Condition	Result	Judgment criteria
Consecutive operating life test	IF=20mA, T=25°C, t=168h	0/12	Forward Voltage $V_F(V) = \text{Upper Limit} \times 1.2$ Reverse Leakage Current $I_R(\mu A) = \text{Upper Limit} \times 2.0$ Luminous Intensity I_v (mcd) = Lower Limit $\times 0.7$
High temperature storage life test	T=100°C, t=168h	0/12	
Low temperature storage life test	T=-25°C, t=168h	0/12	
high Temperature humidity storage life test	T=85 ± 2°C, RH=85% ± 3, t=168h	0/12	
Temperature cycle test	-25°C~25°C~100°C, 30min 5min 30min 10cycles	0/12	
Thermal shock test	100°C 0°C 5min 5min 20 cycles	0/12	
Soldering heat test	T=260 ± 5°C, t=10s ± 1s	0/12	
Solderability test	T=230 ± 5°C, t=5s ± 0.5s	0/12	Steeped Part ≥ 95%
Fall test	h=100cm, Free fall, 3times	0/12	Intact
Terminal strength test	W=9.8N, t=30 ± 5s	0/12	
Lead Bending test	W=4.9N, 2times	0/12	