

SPECIFICATION

CUSTOMER : _____

DEVICE NAME : IRED Lamp _____

MODEL NO. : CLI3337-H _____

ISSUED DATE : 2019.05.23 _____

Code No. : _____

APPROVAL NO.				
APPROVAL DATE				
	INSPECTOR	CHECK	CHECK	APPROVAL
	INSPECTOR	CHECK	CHECK	APPROVAL



1. Features

- ▶ Very highly efficient GaAs Chip.
- ▶ High reliability.
- ▶ High pulse handling capability.
- ▶ Good spectral match to silicon photo detectors.

2. Applications

- ▶ IR remote control for HIFI and TV sets, video tape recorders, dimmers.
- ▶ Light-reflection switches(max.500kHz).
- ▶ Coin counters. Sensor technology.
- ▶ Discrete opto couplers.

3. Package Dimensions

Unit : mm

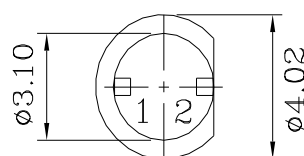
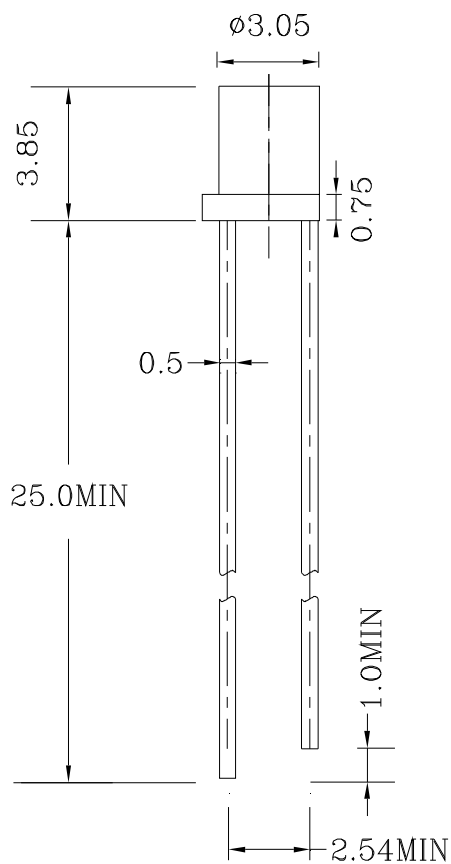

PIN Connections

1. Anode
2. Cathode

Notes :

Tolerance is ± 0.25 mm unless otherwise noted.

4. Absolute maximum ratings

Ta=25°C

Item	Symbol	Ratings	Unit
Forward Current	I _F	100	mA
Pulse Forward Current *1	I _{FP}	500	mA
Power Dissipation	P _D	150	mW
Reverse Voltage	V _R	5	V
Operating Temperature	T _{opr}	-30~85	°C
Storage Temperature	T _{stg}	-30~100	°C
Soldering Temperature *2	T _{sol}	260±5 °C	°C

*1. Pulse Width=0.1msec, Duty ratio = 1/10

*2. 5 sec at location 2.0mm away from the base of the epoxy bulb.

5. Electrical Characteristics

Ta=25°C

Item	Symbol	Test Condition	Min	Typ	Max	Unit
Forward Voltage	V _F	I _F = 50mA	-	-	1.6	V
Reverse Current	I _R	V _R =5[V]	-	-	10	μA
Radiant Intensity *3	I _E	I _F = 50mA	3	-	5	mW / sr
			5	-	7	
			7	-	10	
Peak Wavelength	λ _P	I _F = 50mA	-	940	-	nm
Spectrum Radiation Band width	Δλ	I _F = 50mA	-	50	-	nm
Viewing Angle	θ1/2	I _F = 50mA	-	±55	-	deg

*3. This Value includes ±20% tolerance caused by Luminous Intensity measurement method of Ciellight Co.LTD

6.Characteristic Diagrams (typical)

Fig.1 $I_F - V_F$

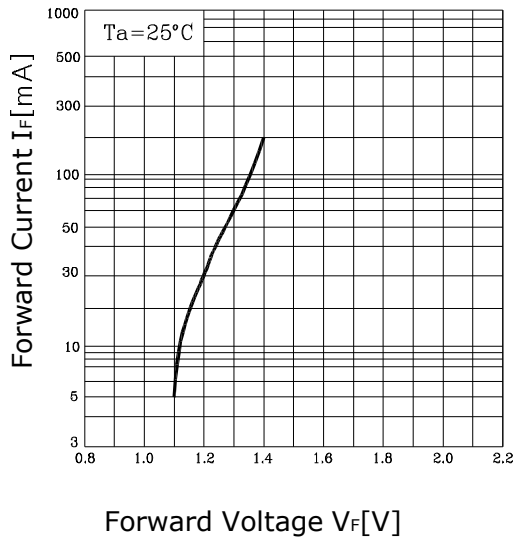

Fig.2 $I_F - T_a$

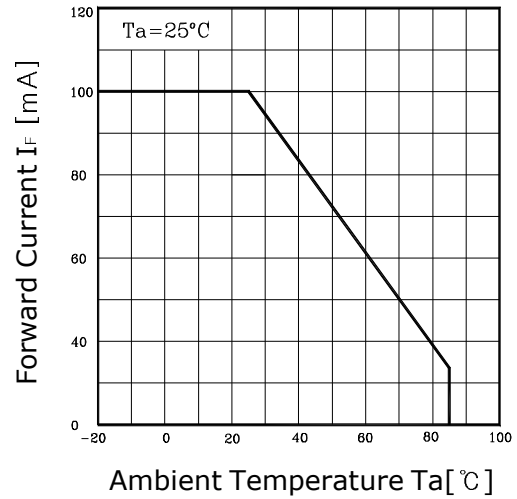

Fig.3 Spectrum

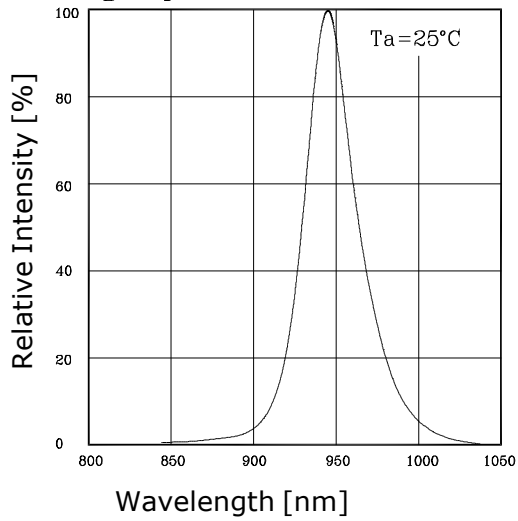

Fig.4 $I_E - I_F$

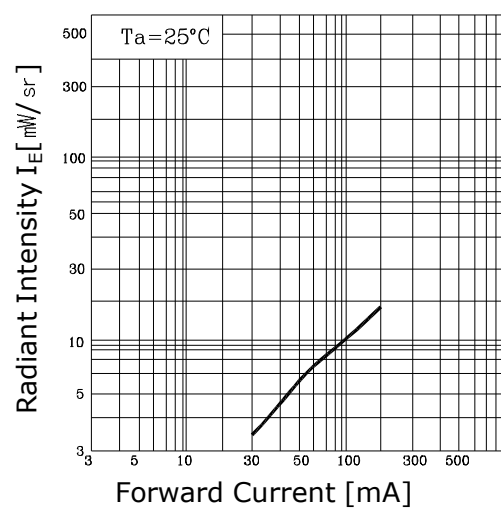
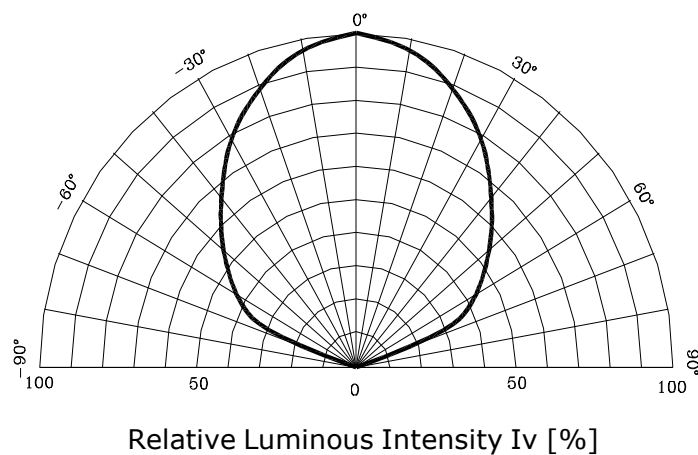

Fig.5 Radiation Characteristics



7-1. Soldering conditions

(1) The LEDs can be soldered in place using the reflow soldering method.

Ciellight does not make any guarantee on the LEDs after they have been assembled using the dip soldering method.

(2) Recommended soldering conditions

	Reflow Soldering		Hand Soldering	
	Lead Solder	Lead-free Solder	Temperature	350°C Max. 3sec Max. (one time only)
Pre-Heat	120~150°C	180~200°C		
Pre-Heat Time	120sec Max.	120sec Max.		
Peak Temperature	240°C Max.	260°C Max.		
Soldering Time	5sec Max.	5sec Max.		
Condition	refer to profile ①	refer to profile ②		

* Although the recommended soldering conditions are specified in the above table, reflow soldering at the lowest possible temperature is desirable for the LEDs.

* A rapid-rate process is not recommended for cooling the LEDs down from the peak temperature.

[Temperature-Profile (surface of circuit board)]

Use the conditions shown to the following figures.

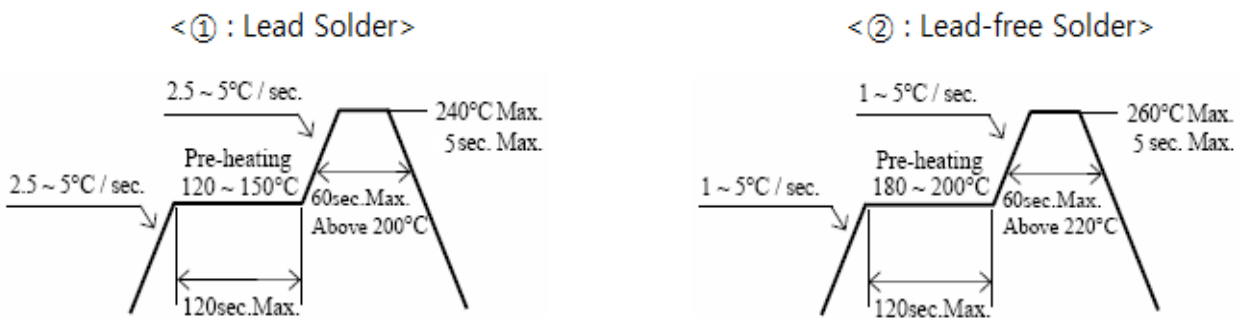

7-2. TTW Soldering

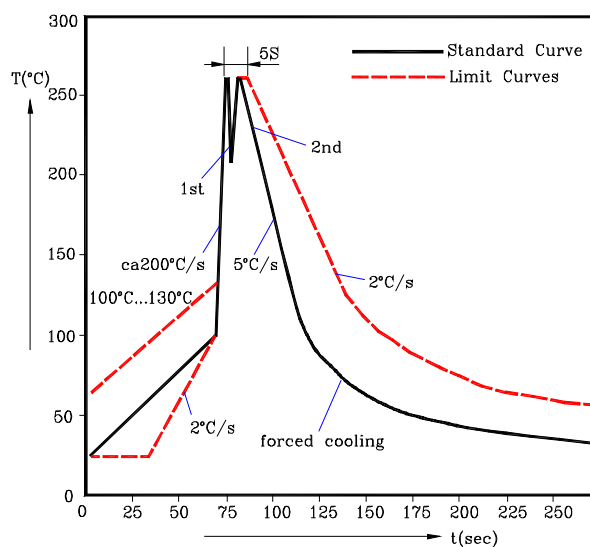

8. Reliability Test Items and Conditions

8-1. The Reliability criteria of LED Lamps

Item	Symbol	Test Condition	Limit	
			Min	Max
Forward Voltage	V_F	$I_F=50mA$	-	U.S.L. \times 1.1
Luminous Intensity	I_v	$I_F=50mA$	L.S.L. \times 0.7	-

8-2. Results of Reliability Test

NO	Item	Test Condition	Test Hours/ Cycles	Sample Size	Ac/Re
1	Solder Heat	Temp : 260°C \pm 5°C	5 SEC	20 PCS	0/1
2	Temperature Cycle	H : +100°C 30min 5 min L : -40°C 30min	100 CYCLE	20 PCS	0/1
3	Thermal Shock	H : +100°C 5min 10 sec L : -40°C 5min	100 CYCLE	20 PCS	0/1
4	High Temperature Storage	Temp : 85°C	1000 HRS	20 PCS	0/1
5	Low Temperature Storage	Temp : -40°C	1000 HRS	20 PCS	0/1
6	Life Test	Ta=RT, $I_f = 20$ mA	1000 HRS	20 PCS	0/1
7	High Temperature / High Humidity	Ta=85°C / RH=85%	1000 HRS	20 PCS	0/1

* This data is not results about this product , but results of another device used by similar raw materials.

9. Caution on usage

9-1. Static electricity and surge will damage the LEDs. It is recommended to take measures to prevent ESD problem (for example, grounding equipment and the human body, using grounded soldering iron and so on).

9-2. Be careful never to exceed, even momentarily, the absolute maximum ratings specified in the data sheet.

9-3. Ciel Light will not be held responsible for any damage to the user that may result from accidents or any other reasons during operation of the user's unit if use to exceed the absolute maximum ratings, or not keep the matters that demand special attention.

9-4. Store and use where there is no corrosive gas.

9-5. While the device is operational across the temperature range, functionality will with temperature. Specifications are stated only.

9-6. Stresses beyond those listed under "absolute maximum ratings" may cause permanent damage to the device. These are stress ratings only, and functional operation of the device at these or any other conditions beyond those indicated under "recommended operating conditions" is not implied. Exposure to absolute-maximum-rated conditions for extended periods may affect device reliability.

10. Warranty period : One year after delivery.
