

GlobTek, Inc. www.globtek.com 186 Veterans Drive, Northvale, NJ 07647 Tel. (201) 784-1000 Fax (201) 784-0111	Drawing Title: GT-96180-1830-6.0-T3-PP GT-96180-1830-6.0-T3-PP PoE, Passive Power Injector Efficiency Level: USA DOE Level VI / Eco-design Directive 2009/125/EC, (EU) 2019/1782, Case Color/Style: GlobTek Black, Desktop/External Single Port Power Over Ethernet Midspan (IEEE802.3af PoE PSE), Input Rating: 100-240V~, 50-60 Hz IEC 60320/C14 Output Rating: 18.00W, 24.0V@0.75A Pin Out: PoE injector wiring Data, Data+Power, RJ45 x 2	
	Model No. GT-96180-1830-6.0-T3-PP	Part No./Ordering No. GT-96180-1824-T3-PP

In Addition to GlobTek Inc.'s renewed ISO9001:2015 - Quality Management System Certification, GlobTek Inc. is now certified to:

ISO13485:2016 - Medical Devices Quality Management System Certification
 ISO14001:2015 - Environmental Management System Certification

ISO Certificates are available online at <https://www.globtek.com/iso-certificates/>

The acceptance of this specification and use of the product described in this document indicates the acceptance and binding of the customer to Globtek TERMS AND CONDITIONS (attached to the end of this document), which supersede all other agreements, terms, and conditions (<https://www.globtek.com/terms-and-conditions/>).

The purchaser of this product (Customer) agrees that it is their sole responsibility to determine suitability/fitness of the product described in this specification for their application and to take precautions for protection against any hazards attendant to the handling and use of the product.

Footnote:

GlobTek Inc. will not be liable for the safety and performance of these power supplies/battery packs if unauthorized access and repair occurs. End user should consult applicable UL, CSA or EN standards for proper installation instruction.

Limitation of Use:

GlobTek products are intended for use with commercial, medical, and/or industrial equipment only. GlobTek product are not authorized for use as mission critical components in life support hazardous environment, nuclear or aircraft applications without prior written approval from the CEO of GlobTek Inc.

Contents of this document are subject to change without prior notice.

Customer Approval of Specification:

Please approve, sign and send back to GlobTek so we can complete order processing.
 A delay in receipt of this form will delay delivery schedule.

Company Name: _____	Customer P/N: _____
Quote Number: _____	Date: _____
Authorized Representative Name: _____	Authorized Representative Signature: _____

GlobTek, Inc. www.globtek.com 186 Veterans Drive, Northvale, NJ 07647 Tel. (201) 784-1000 Fax (201) 784-0111	Drawing Title: GT-96180-1830-6.0-T3-PP GT-96180-1830-6.0-T3-PP PoE, Passive Power Injector Efficiency Level: USA DOE Level VI / Eco-design Directive 2009/125/EC, (EU) 2019/1782, Case Color/Style: GlobTek Black, Desktop/External Single Port Power Over Ethernet Midspan (IEEE802.3af PoE PSE), Input Rating: 100-240V~, 50-60 Hz IEC 60320/C14 Output Rating: 18.00W, 24.0V@0.75A Pin Out: PoE injector wiring Data, Data+Power, RJ45 x 2	
	Model No. GT-96180-1830-6.0-T3-PP	Part No./Ordering No. GT-96180-1824-T3-PP

Rev C

REVISION HISTORY

REV	DESCRIPTION	SUB	DATE	APPROVED
C	Update pinout to POE RJ45X2, change packing: master carton dimensions to 442*330*275 mm, gift box dimensions to 125*105*43 mm, Qty to 60 pcs/carton Update grounding configuration from E1 to F3	QA	08/20/2019	QA
B	Change Input current from 0.5A to 0.6A, add EAC	QA	06/01/2018	QA
A	Initial Release	jwarn	05/02/2017	QA

POWER SUPPLY INFORMATION

TYPE	Desktop/External
TECHNOLOGY	Single Port Power Over Ethernet Midspan (IEEE802.3af PoE PSE)
CASE COLOR	GlobTek Black
NAMEPLATE RATED INPUT	100-240V~, 50-60 Hz, 0.6A
INPUT CONFIG	IEC 60320/C14
WATTS	18.00
VOLTS OUT	24.0
CURRENT OUT (Amps)	0.75
BLADE/CORD INCLUDED	N/A Not Applicable
BLADE/CORD INSTALLED	N/A Not Applicable
INGRESS PROTECTION	
GROUNDING CONFIGURATION	(F3) Floating output, capacitor between output common and functional earth
EFFICIENCY LEVEL	USA DOE Level VI / Eco-design Directive 2009/125/EC, (EU) 2019/1782
OUTPUT CONFIGURATION	N/A mm, N/A/ Cond, N/A, None, Ferrite: None, N/A, GT Cord # C0745
CONNECTOR PIN OUT	PoE injector wiring Data, Data+Power, RJ45 x 2
LABEL SPECS	Standard GT,L-1186
SPECIAL BARCODE LABEL MATERIAL	No
PACK SPEC	Standard DT, Cellular packaging, User manual
USER MANUAL	809-DESKTOPUSERMANUAL on A4 paper

PROPRIETARY INFORMATION

PROPRIETARY OF GLOBTEK, INC. ANY REPRODUCTION, DISCLOSURE OR USE OF THIS DRAWING, IN WHOLE OR IN PART, IS HEREBY PROHIBITED EXCEPT AS SPECIFIED IN WRITING BY GLOBTEK, INC. © GlobTek, Inc. 2017 - 2025

GlobTek, Inc. www.globtek.com 186 Veterans Drive, Northvale, NJ 07647 Tel. (201) 784-1000 Fax (201) 784-0111	Drawing Title: GT-96180-1830-6.0-T3-PP GT-96180-1830-6.0-T3-PP PoE, Passive Power Injector Efficiency Level: USA DOE Level VI / Eco-design Directive 2009/125/EC, (EU) 2019/1782, Case Color/Style: GlobTek Black, Desktop/External Single Port Power Over Ethernet Midspan (IEEE802.3af PoE PSE), Input Rating: 100-240V~, 50-60 Hz IEC 60320/C14 Output Rating: 18.00W, 24.0V@0.75A Pin Out: PoE injector wiring Data, Data+Power, RJ45 x 2	
	Model No. GT-96180-1830-6.0-T3-PP	
	Part No./Ordering No. GT-96180-1824-T3-PP	Rev C

Notes/Modifications/Customizations (notes in this section supersede the values shown in the standard spec)
DIMENSIONS ARE IN MM UNLESS SPECIFIED OTHERWISE

GlobTek, Inc. www.globtek.com 186 Veterans Drive, Northvale, NJ 07647 Tel. (201) 784-1000 Fax (201) 784-0111	Drawing Title: GT-96180-1830-6.0-T3-PP GT-96180-1830-6.0-T3-PP PoE, Passive Power Injector Efficiency Level: USA DOE Level VI / Eco-design Directive 2009/125/EC, (EU) 2019/1782, Case Color/Style: GlobTek Black, Desktop/External Single Port Power Over Ethernet Midspan (IEEE802.3af PoE PSE), Input Rating: 100-240V~, 50-60 Hz IEC 60320/C14 Output Rating: 18.00W, 24.0V@0.75A Pin Out: PoE injector wiring Data, Data+Power, RJ45 x 2	
	Model No. GT-96180-1830-6.0-T3-PP	
	Part No./Ordering No. GT-96180-1824-T3-PP	Rev C

ELECTRICAL SPECIFICATIONS

GlobTek's 18W and 36W Passive Power over Ethernet Midspan Injectors offers cost effective and reliable solution for remote powering of specialized non-standard Ethernet Powered Devices requiring up to 36 Watts over existing network infrastructure. These Passive Injectors are configured to provide 18 or 36 watts of power over two pairs (4,5 + and 7,8 -) per IEEE 802.3 defined wires.

When the load device is connected, GlobTek's Passive PoE Injector will immediately source power to the Powered Device.

GlobTek's 56W Passive PoE Injectors are designed to function with and provide power to any IEEE 802.3af or 802.3at PoE device.

For specialized applications Globtek can also provide lower output voltage models between 18V and 54V with reduced circuit complexity, these are referred to as our Simple Power over Ethernet Injector products.

MAIN FEATURES

- Cost Effective Passive PoE, supplies continuous power without requiring handshaking communications
- Output can source up to 18W or 36W at 18V, 24V, 36V, 48V, 54V or 56V
- Withstands high energy EMI Immunity events without going into latched shutdown state
- Short Circuit and Overload Protection protects Ethernet cabling if Splitter has a Short Circuit
- Green LED Indicates Output Power Availability
- Passive PoE models can transfer 10/100/1000 BaseT Data Rates (Gigabit compatible)
- Simple, Low Cost PoE models can transfer 10/100 BaseT Data Rates
- Universal Input Power from 100Vac to 240Vac
- Green Design: Compliant to DoE Efficiency level VI requirement
- Full Protection for Over Voltage and Current
- Compact 104 x 54 x 40 mm (w/o MTG Flange)

APPLICATIONS

- Custom Ethernet Power Distribution Architecture
- Network Security Cameras
- Point of Sales
- Industrial Controllers
- Electronic Time Card Readers
- Building Security Systems
- Network Camera with Pan, Tilt and Zoom Features
- Electronic Signs
- RFID Readers
- Motion Sensors
- HVAC Controllers
- Magnetic Card Readers
- Digital Time clock

A) ELECTRICAL SPECIFICATIONS:

INPUT

GlobTek, Inc. www.globtek.com 186 Veterans Drive, Northvale, NJ 07647 Tel. (201) 784-1000 Fax (201) 784-0111	Drawing Title: GT-96180-1830-6.0-T3-PP GT-96180-1830-6.0-T3-PP PoE, Passive Power Injector Efficiency Level: USA DOE Level VI / Eco-design Directive 2009/125/EC, (EU) 2019/1782, Case Color/Style: GlobTek Black, Desktop/External Single Port Power Over Ethernet Midspan (IEEE802.3af PoE PSE), Input Rating: 100-240V~, 50-60 Hz IEC 60320/C14 Output Rating: 18.00W, 24.0V@0.75A Pin Out: PoE injector wiring Data, Data+Power, RJ45 x 2	
	Model No. GT-96180-1830-6.0-T3-PP	Part No./Ordering No. GT-96180-1824-T3-PP
		Rev C

Input Range: 90-264 Vac (85-264Vac @ 85% of rated output power)
Input Line Frequency: 47-63Hz
Input Current:< 1A RMS @ 90Vac Full Load for 36W
 < 0.6A RMS @ 90Vac Full Load for 18W
Inrush Current: 30/60A max at 115/230Vac
No load Power: < 100mW
Efficiency: > 87.4%, 4 Point Avg efficiency. Typical at Full Load for 36W
 > 85.0%, 4 Point Avg efficiency. Typical at Full Load for 18W
Turn on-delay: 1 Second Typical @ 115Vac
Input Line Protection: MOV Transient protected.
Hold-up time: 8ms typical at nominal input voltage and full load
Touch current at output: <100uA
Earth Leakage current at input: <100uA
Isolation: Input to Output, 3000 VAC

OUTPUT

Power Injection Pins: 4&5 for V+ and 7&8 for Common
Port Voltage: 56V standard, 18V to 54V optional
Port Power: 18W or 36W Max
Port Voltage Regulation: +/-3%, and less than 57Vdc
Port Voltage Ripple: 100mVpp max

B) ENVIRONMENTAL

Temperature: Operating, -10C to 40C
Storage, -30C to 80C
Humidity: 0% to 95% Relative Humidity, Non-Condensing
Altitude: Operating, Up to 5000M

C) MECHANICALS / ENCLOSURE

Housing: High impact plastic, 94V0 polycarbonate, non-vented
Markings: Label and/or Pad Printed and/or Molded in the case
Dimensions: 104*54*40 mm (w/o MTG Flange)
Weight: 0.35 Lb, 155 gr.
AC Input mechanical options: Desktop C6, C8, C14 or C18 IEC Inlet.
 Hybrid option (Desktop or Changeable Blade Wall Plug-in) Class I or Class II input
Data and Data+Power Connector: Fully Shielded RJ45

D) EMISSIONS and IMMUNITY

Emission: Meets FCC Class B Part 15, EN55022 Class B
Immunity: Meets the following;
EN61000-6-2 (Industrial Level Immunity Compliance, extended levels shown in parenthesis)

GlobTek, Inc. www.globtek.com 186 Veterans Drive, Northvale, NJ 07647 Tel. (201) 784-1000 Fax (201) 784-0111	Drawing Title: GT-96180-1830-6.0-T3-PP GT-96180-1830-6.0-T3-PP PoE, Passive Power Injector Efficiency Level: USA DOE Level VI / Eco-design Directive 2009/125/EC, (EU) 2019/1782, Case Color/Style: GlobTek Black, Desktop/External Single Port Power Over Ethernet Midspan (IEEE802.3af PoE PSE), Input Rating: 100-240V~, 50-60 Hz IEC 60320/C14 Output Rating: 18.00W, 24.0V@0.75A Pin Out: PoE injector wiring Data, Data+Power, RJ45 x 2	
	Model No. GT-96180-1830-6.0-T3-PP	
	Part No./Ordering No. GT-96180-1824-T3-PP	Rev C

EN 61000-4-2 ESD (+/-18KV Air, +/-8KV Contact, criteria A) (+/-20KV Air, +/-10KV Contact, criteria B)

EN 61000-4-3 Radiated Immunity

EN 61000-4-4 EFT (+/-2.5KV, criteria A) (+/-4KV, criteria B)

EN 61000-4-5 Surge (+/-2KV Line-Line, +/-4KV Line to Gnd, criteria A)

EN 61000-4-6 Conducted Susceptibility

EN 61000-4-11 Voltage Dips and Interrupts

EN 61000-3-2 Harmonics, Class A

E) SAFETY APPROVALS

Compliant Safety Standards: See listings at end of this drawing for specifics

F) INTEROPERABILITY: Passive and Simple 48V and 56V models work with all types of AF and AT Splitters and PoE appliances with appropriate input power requirements

G) SPECIAL OPTIONS

1. Custom Markings
2. High Rel PCB laminate with Plated through Holes for IPC610 Class 2 Compliance
3. Special Housing Color
4. Reduced Output Voltage, 18V to 54V

GlobTek, Inc. www.globtek.com 186 Veterans Drive, Northvale, NJ 07647 Tel. (201) 784-1000 Fax (201) 784-0111	Drawing Title: GT-96180-1830-6.0-T3-PP GT-96180-1830-6.0-T3-PP PoE, Passive Power Injector Efficiency Level: USA DOE Level VI / Eco-design Directive 2009/125/EC, (EU) 2019/1782, Case Color/Style: GlobTek Black, Desktop/External Single Port Power Over Ethernet Midspan (IEEE802.3af PoE PSE), Input Rating: 100-240V~, 50-60 Hz IEC 60320/C14 Output Rating: 18.00W, 24.0V@0.75A Pin Out: PoE injector wiring Data, Data+Power, RJ45 x 2	
	Model No. GT-96180-1830-6.0-T3-PP	
	Part No./Ordering No. GT-96180-1824-T3-PP	Rev C

18W PoE Injector, Ethernet InterOperability and Compatibility Testing

Injector tested: *Model GT-96180-1856*, rated 18W output, 56Vdc, IEEE802.3-2003 af Compliant

Note, assuming 80% eff splitter, max Pout = 14.4W (14.4/18 = 0.8)

Splitter Model Used	Splitter Description	Splitter O/P Power Rating	Splitter Load During Testing
GlobTek GT-91087	5V, af type	8W	7.5W
PowerDSine PD-AS-601/5	5V, af type	10W	
Linksys POEES5	5V, af type	10W	
Axis 5008-001-02	5V, af type	10W	
PowerDSine PD-AS-701/12	12V, at type	24W	14W
Phihong POE21-120-R	12V, at type	21W	
Cisco 7970 Series Phone	IP Phone, af type	Input to Phone rating 48V, 0.38A	

100BaseT/1000 Base T network digital transmission testing

(During testing ethernet communications is passed thru Injector and then Splitter and then to a computer)

Injector tested: *Model GT-96180-1856*, rated 18W output, 56Vdc, IEEE802.3-2003 af Compliant

Injector is Gigabit designed and tested, to 100 Base T and 1000 Base T

Splitter Model Used	Splitter Description	P/F	Notes:
Axis 5008-001-02	100 Base T rating	P	Limited bandwidth splitter
PowerDSine PD-AS-701/12	1000 Base T rating	P	Full bandwidth splitter

TO ADDRESS SYSTEM-LEVEL EMI CONCERNS, FERRITE CHOKES/BEADS MAY BE ADDED/REVISED UPON REQUEST. A SAMPLE KIT OF GLOBTEK'S STANDARD FERRITES IS AVAILABLE UNDER GLOBTEK P/N: EMI-MITIGATION-KIT1

FOR ADDITIONAL INFORMATION, PLEASE READ OUR WHITE PAPER AT: <https://r.globtek.info/3QeaqtD>

GlobTek, Inc.
www.globtek.com
186 Veterans Drive,
Northvale, NJ 07647
Tel. (201) 784-1000
Fax (201) 784-0111

Drawing Title: GT-96180-1830-6.0-T3-PP GT-96180-1830-6.0-T3-PP PoE, Passive Power Injector Efficiency Level: USA DOE Level VI / Eco-design Directive 2009/125/EC, (EU) 2019/1782, Case Color/Style: GlobTek Black, Desktop/External Single Port Power Over Ethernet Midspan (IEEE802.3af PoE PSE), Input Rating: 100-240V~, 50-60 Hz IEC 60320/C14 Output Rating: 18.00W, 24.0V@0.75A Pin Out: PoE injector wiring Data, Data+Power, RJ45 x 2

Model No. GT-96180-1830-6.0-T3-PP

Part No./Ordering No. GT-96180-1824-T3-PP

Rev C

3D File Download <https://www.globtek.com/dl/GT-96180-WVVV-T3-PP.stp>

Mechanical drawing

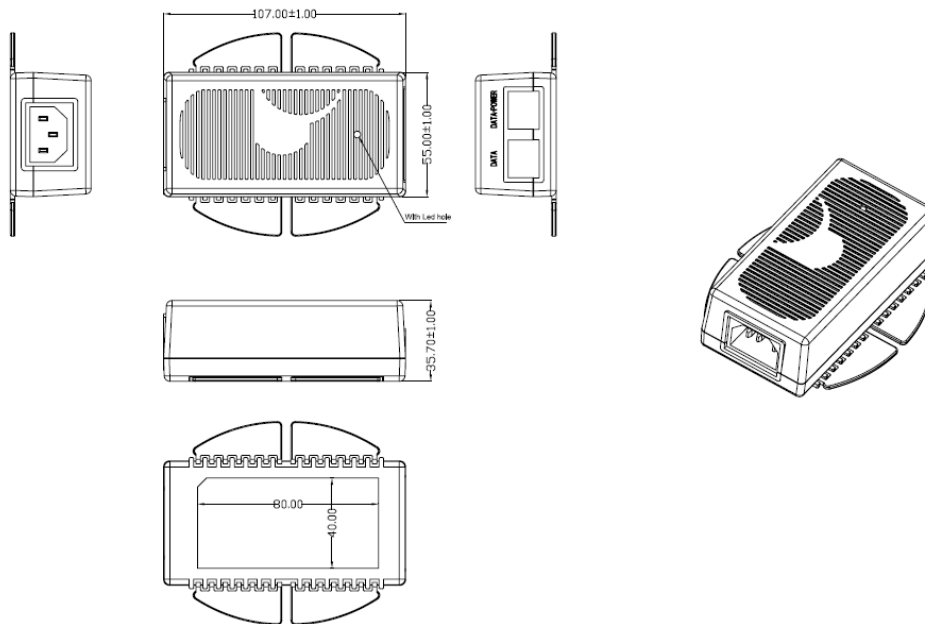

Web Overview

https://www.globtek.com/_0/GT-96180-1824-T3-PP/o

GlobTek, Inc.
 www.globtek.com
 186 Veterans Drive,
 Northvale, NJ 07647
 Tel. (201) 784-1000
 Fax (201) 784-0111

Drawing Title: GT-96180-1830-6.0-T3-PP GT-96180-1830-6.0-T3-PP PoE, Passive Power Injector Efficiency Level: USA DOE Level VI / Eco-design Directive 2009/125/EC, (EU) 2019/1782, Case Color/Style: GlobTek Black, Desktop/External Single Port Power Over Ethernet Midspan (IEEE802.3af PoE PSE), Input Rating: 100-240V~, 50-60 Hz IEC 60320/C14 Output Rating: 18.00W, 24.0V@0.75A Pin Out: PoE injector wiring Data, Data+Power, RJ45 x 2

Model No. GT-96180-1830-6.0-T3-PP

Part No./Ordering No. GT-96180-1824-T3-PP

Rev C

DERATING CURVE

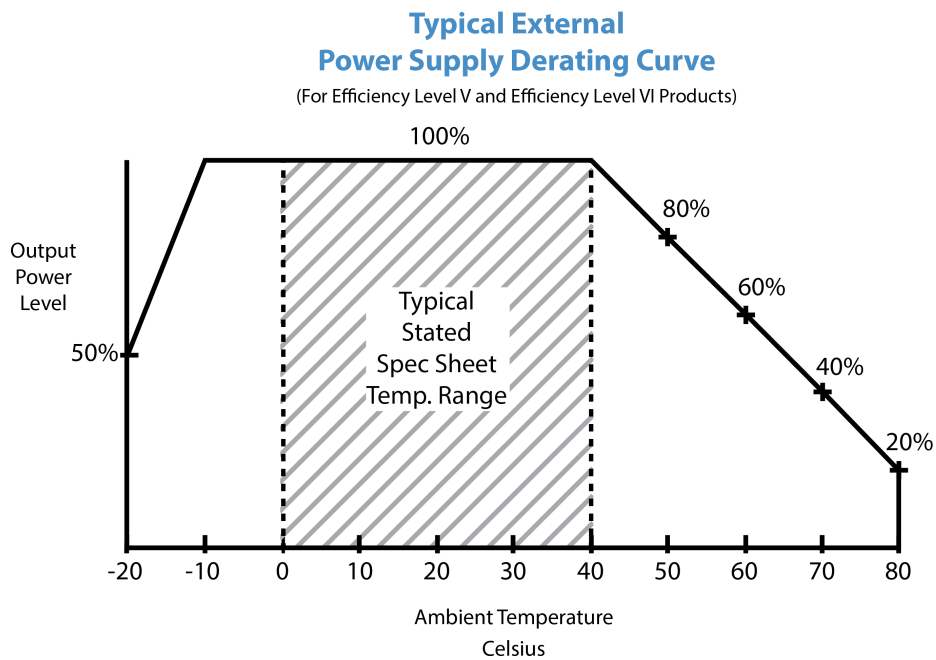

GlobTek, Inc.
www.globtek.com
186 Veterans Drive,
Northvale, NJ 07647
Tel. (201) 784-1000
Fax (201) 784-0111

Drawing Title: GT-96180-1830-6.0-T3-PP GT-96180-1830-6.0-T3-PP PoE, Passive Power Injector Efficiency Level: USA DOE Level VI / Eco-design Directive 2009/125/EC, (EU) 2019/1782, Case Color/Style: GlobTek Black, Desktop/External Single Port Power Over Ethernet Midspan (IEEE802.3af PoE PSE), Input Rating: 100-240V~, 50-60 Hz IEC 60320/C14 Output Rating: 18.00W, 24.0V@0.75A Pin Out: PoE injector wiring Data, Data+Power, RJ45 x 2

Model No. GT-96180-1830-6.0-T3-PP

Part No./Ordering No. GT-96180-1824-T3-PP

Rev C

INPUT CONFIGURATION

(F3) Floating output, capacitor between output common and functional earth

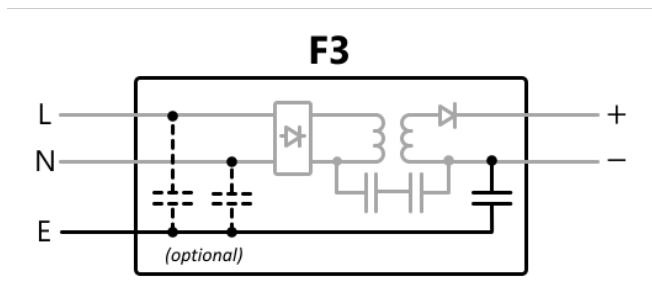

[Alternate grounding configurations](#) available upon request.

Blades/Cord Included:N/ANot Applicable

Blades/Cord Installed:N/ANot Applicable

T3 Inlet (IEC 60320/C14)

IEC 60320/C14 AC Inlet Connector, Class I, Earth Ground

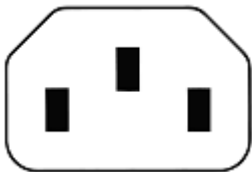

Mates with IEC 60320/C13 Plug

Optional Locking IEC60320 Receptacle and cord option available on some models by request.:



[Standard International IEC 320/C13 Cordsets](#)

Below are standard cordsets which are "not included" (unless stated above); these can be purchased separately or packaged with the power supply. Contact your Sales Engineer if the style required is not shown below. Many more available in different lengths, colors or cable material.

Stock Power Supply Cords

PROPRIETARY INFORMATION

PROPRIETARY OF GLOBTEK, INC. ANY REPRODUCTION, DISCLOSURE OR USE OF THIS DRAWING, IN WHOLE OR IN PART, IS HEREBY PROHIBITED EXCEPT AS SPECIFIED IN Page 10 of 25
WRITING BY GLOBTEK, INC. © GlobTek, Inc. 2017 - 2025

quest / 12/03/2025 5:03:24 AM GMT

GlobTek, Inc. www.globtek.com 186 Veterans Drive, Northvale, NJ 07647 Tel. (201) 784-1000 Fax (201) 784-0111	Drawing Title: GT-96180-1830-6.0-T3-PP GT-96180-1830-6.0-T3-PP PoE, Passive Power Injector Efficiency Level: USA DOE Level VI / Eco-design Directive 2009/125/EC, (EU) 2019/1782, Case Color/Style: GlobTek Black, Desktop/External Single Port Power Over Ethernet Midspan (IEEE802.3af PoE PSE), Input Rating: 100-240V~, 50-60 Hz IEC 60320/C14 Output Rating: 18.00W, 24.0V@0.75A Pin Out: PoE injector wiring Data, Data+Power, RJ45 x 2	
	Model No. GT-96180-1830-6.0-T3-PP	Part No./Ordering No. GT-96180-1824-T3-PP

Rev C

Part Number/ Link	Country	Plug	Termination	Length (mm)	Length (Ft)
3021457F701(R)	N. American (Type B)	NEMA 5-15P	IEC 320/C13	2150	7
1191068F0701(R)	N. American (Type B)	NEMA 5-15P Hospital	IEC 320/C13	2459	8
2194272M5701-T(R)	Argentina (Type I)	IRAM 2073	IEC 320/C13	2500	8
5502022M5701A(R)	Australian (Type I)	AS3112 / 3 PRONG	IEC 320/C13	2500	8
204B4272M5701(R)	Brazil (Type N)	BRAZIL	IEC 320/C13	2500	8
6023602M5701(R)	China (Type I)	CCC GR2099	IEC 320/C13	2500	8
G8014272M5701(R)	Danish (Type K)	AFSNIT SECTION 107-2-D1	IEC 320/C13	2500	8
23144272M5701-T(R)	Europe (Type E)	CEE 7/7	IEC 320/C13	2500	8
23134272M5701EUKR(R)	Europe/Korea Combo (Type E)	CEE 7/7 / KSC8305	IEC 320/C13	2500	8
205IN4272M5701(R)	India (Type D)	India IS 1293 (also known as IA16A3 or BS546)	IEC 320/C13	2500	8
208IN4272M5701(R)	India (Type M)	India IS 1293 (also known as IA16A3 or BS546)	IEC320/C13	2500	8
377C4272M5701(R)	Israel (Type H)	ISL 377C	IEC 320/C13	2500	8
23024272M5701(R)	Italy (Type L)	CEI 23-16/VII	IEC 320/C13	2500	8
3003068F2701-HK(R)	Japan (Type B)	JIS 8303 / 3 PINS	IEC 320/C13	2500	8
3003339F701(R)	Japan (Type B)	JIS 8303 / 3 PINS	IEC 320/C13	2500	8
302J115J6F0701J(R)	North America / Japan (Type B - 12A)	NEMA 5-15P (cULus approved), Japan JIS C 8303 (PSE Approved)	IEC 320/C13	1830	6
302J104J6F0701J(R)	North America / Japan (Type B)	NEMA 5-15P (cULus approved), Japan JIS C 8303 (PSE Approved)	IEC	1830	6

PROPRIETARY INFORMATION

PROPRIETARY OF GLOBTEK, INC. ANY REPRODUCTION, DISCLOSURE OR USE OF THIS DRAWING, IN WHOLE OR IN PART, IS HEREBY PROHIBITED EXCEPT AS SPECIFIED IN WRITING BY GLOBTEK, INC. © GlobTek, Inc. 2017 - 2025 Page 11 of 25

quest / 12/03/2025 5:03:24 AM GMT

GlobTek, Inc. www.globtek.com 186 Veterans Drive, Northvale, NJ 07647 Tel. (201) 784-1000 Fax (201) 784-0111	Drawing Title: GT-96180-1830-6.0-T3-PP GT-96180-1830-6.0-T3-PP PoE, Passive Power Injector Efficiency Level: USA DOE Level VI / Eco-design Directive 2009/125/EC, (EU) 2019/1782, Case Color/Style: GlobTek Black, Desktop/External Single Port Power Over Ethernet Midspan (IEEE802.3af PoE PSE), Input Rating: 100-240V~, 50-60 Hz IEC 60320/C14 Output Rating: 18.00W, 24.0V@0.75A Pin Out: PoE injector wiring Data, Data+Power, RJ45 x 2	
	Model No. GT-96180-1830-6.0-T3-PP	
	Part No./Ordering No. GT-96180-1824-T3-PP	Rev C

	- 15A)		IEC 320/C13		
302JT104J9F0701JT(R)	North America / Japan / Taiwan (Type B - 15A)	NEMA 5-15P (cULus approved), Japan JIS C 8303 (PSE Approved), Taiwan CNS 6797 (BSMI Approved)	IEC 320/C13	2800	9
2313K3432M5701(R)	Korea (Type F)	KS C 8305	IEC 320/C13	2500	8
5804272M5701(R)	Russia (Type F)	GOST 7396	IEC 320/C13	2500	8
2084272M5701(R)	South Africa (Type M)	South Africa SABS164-1 (16A type)	IEC 320/C13	2500	8
23214272M5701(R)	Switzerland (Type J)	SEV 1011	IEC 320/C13	2500	8
3003322M5701(R)	Taiwan (Type B)	BSMI	IEC 320/C13	2500	8
6363762M5701(R)	Thailand (Type O)	TIS 166-2549	IEC 320/C13	2500	8
PZ0800100-2M5BK13H(R)	UK, Hong Kong, Singapore, Gulf States (Type G)	BS 1363A	IEC 320/C13	2500	8
7055002M5701A(R)	International	IEC 320 C14-C13	IEC 320/C13	2500	8

GlobTek, Inc. www.globtek.com 186 Veterans Drive, Northvale, NJ 07647 Tel. (201) 784-1000 Fax (201) 784-0111	Drawing Title: GT-96180-1830-6.0-T3-PP GT-96180-1830-6.0-T3-PP PoE, Passive Power Injector Efficiency Level: USA DOE Level VI / Eco-design Directive 2009/125/EC, (EU) 2019/1782, Case Color/Style: GlobTek Black, Desktop/External Single Port Power Over Ethernet Midspan (IEEE802.3af PoE PSE), Input Rating: 100-240V~, 50-60 Hz IEC 60320/C14 Output Rating: 18.00W, 24.0V@0.75A Pin Out: PoE injector wiring Data, Data+Power, RJ45 x 2	
	Model No. GT-96180-1830-6.0-T3-PP	Part No./Ordering No. GT-96180-1824-T3-PP

OUTPUT CONNECTOR HOOK UP

TO ADDRESS SYSTEM-LEVEL EMI CONCERNS, FERRITE CHOKES/BEADS MAY BE ADDED/REVISED UPON REQUEST. A SAMPLE KIT OF GLOBTEK'S STANDARD FERRITES IS AVAILABLE UNDER GLOBTEK P/N: EMI-MITIGATION-KIT1

FOR ADDITIONAL INFORMATION, PLEASE READ OUR WHITE PAPER AT:

<https://www.globtek.com/en/technical-articles/ferrite-kit-radiated-emi-suppression-kit-for-globtek-power-supplies-cable-assemblies>

GlobTek, Inc. www.globtek.com 186 Veterans Drive, Northvale, NJ 07647 Tel. (201) 784-1000 Fax (201) 784-0111	Drawing Title: GT-96180-1830-6.0-T3-PP GT-96180-1830-6.0-T3-PP PoE, Passive Power Injector Efficiency Level: USA DOE Level VI / Eco-design Directive 2009/125/EC, (EU) 2019/1782, Case Color/Style: GlobTek Black, Desktop/External Single Port Power Over Ethernet Midspan (IEEE802.3af PoE PSE), Input Rating: 100-240V~, 50-60 Hz IEC 60320/C14 Output Rating: 18.00W, 24.0V@0.75A Pin Out: PoE injector wiring Data, Data+Power, RJ45 x 2	
	Model No. GT-96180-1830-6.0-T3-PP	Part No./Ordering No. GT-96180-1824-T3-PP
		Rev C

LABEL:L-1186

LABEL P/N	Standard GT
MATERIAL	Flat Thermal Transfer, Imprintable, Polyester Label and/or Pad Printed and/or Molded, and/or Laser Engraved in the case
BACKGROUND COLOR	Black if housing is Black, White or Silver if housing is White or Gray.
TEXT COLOR	White or Silver if label is Black Background for Black housing. Black if label is White or Silver background and Housing is White or Gray.
LABEL WIDTH (mm)	40
LABEL HEIGHT (mm)	80
SPECIAL BARCODE LABEL MATERIAL	No

Below is the minimum information which will appear on the label. NOTE: in the logo area additional/actual positioning of symbols and text is subjected to change as per agency updates/requirements or additional model approvals become available. Regulatory certifications/label markings may be in logo area on the label or molded into the case housing outside the label area. Information will be shown via label and/or pad printed and/or molded and/or laser engraved in the case. * Date code markings at GlobTek option

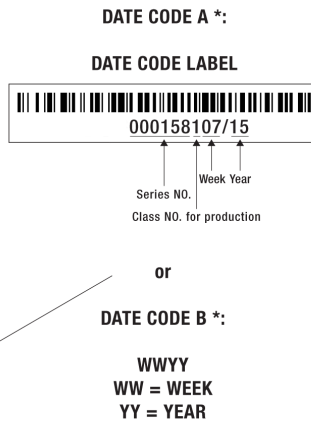

- A=PoE, Passive Power Injector
- B=Model (型号): GT-96180-1830-6.0-T3-PP
- C=P/N (料号): GT-96180-1824-T3-PP
- D=Input (输入)100-240V~, 50-60 Hz 0.6A
- E=Output (输出)24.0 V 0.75 A, 18.00W

GlobTek, Inc. www.globtek.com 186 Veterans Drive, Northvale, NJ 07647 Tel. (201) 784-1000 Fax (201) 784-0111	Drawing Title: GT-96180-1830-6.0-T3-PP GT-96180-1830-6.0-T3-PP PoE, Passive Power Injector Efficiency Level: USA DOE Level VI / Eco-design Directive 2009/125/EC, (EU) 2019/1782, Case Color/Style: GlobTek Black, Desktop/External Single Port Power Over Ethernet Midspan (IEEE802.3af PoE PSE), Input Rating: 100-240V~, 50-60 Hz IEC 60320/C14 Output Rating: 18.00W, 24.0V@0.75A Pin Out: PoE injector wiring Data, Data+Power, RJ45 x 2	
	Model No. GT-96180-1830-6.0-T3-PP	Part No./Ordering No. GT-96180-1824-T3-PP
		Rev C

AGENCY ONLINE DOCUMENTS	http://www.globtek.info/certs/GT-96180-POE/
CE EC-Declaration for Medical	Contact GlobTek for more information
CE EC-Declaration for Industrial/Commercial/ITE	https://cs.globtek.info/ec_declaration_product?id=01ta0000007dRJv&i=2
CE EC-Declaration for Household	Contact GlobTek for more information
UKCA-Declaration for Medical	Contact GlobTek for more information
UKCA-Declaration for Industrial/Commercial/ITE	https://cs.globtek.info/ukca_declaration_product?id=01ta0000007dRJv&i=2
UKCA-Declaration for Household	Contact GlobTek for more information
Morocco SDoC Declaration	https://cs.globtek.info/Morocco_SDoC_Declaration?id=a00a0000000JPEFEA5
RoHS/RoHS3 Declaration	https://www.globtek.com/dcs/SPJ8VNRYGEDZs5tKNE33KuMhrrnow
REACH Declaration	https://www.globtek.com/_0yGEDZs5tKNE33KuMhrrnow/reach-letter
Conflict Minerals Declaration	https://www.globtek.com/r2/vZY8R5
Prop 65 Statement	https://www.globtek.com/r2/PH7CNf
Additional Compliance Documents	https://www.globtek.com/dcs/TKN7SG1/yGEDZs5tKNE...

IPXY rating is based on 3rd party testing and customers should check suitability and test system level IPXY rating before ordering.

Regulatory Certifications/Label Markings

Below follows a link to the latest regulatory certifications and marks for this specific product. National standards as well as certification schemes are constantly changing and so is the set of certification marks and symbols applicable to this product. Various standards, marks and symbols, and certificates are subject to change at any time without notice.

Additional standards or unique country certifications are available upon request. Please contact Globtek to request a quotation.

LATEST PRODUCT/MODEL CERTIFICATIONS: <https://www.globtek.com/ds/6CCoSujMrdM/tUsjMAE6QuZ.html#datasheet>

AGENCY ONLINE DOCUMENTS <http://www.globtek.info/certs/GT-96180-POE/>



(F3) Floating output, capacitor between output common and functional earth

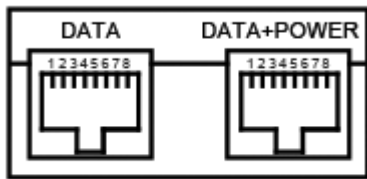

J1 Pins
J2 Power: 4, 5(+)
J2 Pins
7, 8(-)

PoE injector wiring Data, Data+Power, RJ45 x 2

GlobTek, Inc. www.globtek.com 186 Veterans Drive, Northvale, NJ 07647 Tel. (201) 784-1000 Fax (201) 784-0111	Drawing Title: GT-96180-1830-6.0-T3-PP GT-96180-1830-6.0-T3-PP PoE, Passive Power Injector Efficiency Level: USA DOE Level VI / Eco-design Directive 2009/125/EC, (EU) 2019/1782, Case Color/Style: GlobTek Black, Desktop/External Single Port Power Over Ethernet Midspan (IEEE802.3af PoE PSE), Input Rating: 100-240V~, 50-60 Hz IEC 60320/C14 Output Rating: 18.00W, 24.0V@0.75A Pin Out: PoE injector wiring Data, Data+Power, RJ45 x 2	
	Model No. GT-96180-1830-6.0-T3-PP	Rev C
Part No./Ordering No. GT-96180-1824-T3-PP		

PACKAGING

Packing Spec P/N	Standard DT, Cellular packaging, User manual
Packing Quantity/Multiple/MPQ	60
Gift Box Size (mm)	125*105*43
Gift Box Color	White
Master Carton Size (mm)	442 x 330 x 275
Master Carton Cubic Volume (m³)	0.04
Master GW (Kg)	kg
BLADES INCLUDED	N/A: Not Applicable
BLADE/CORD INSTALLED	N/A: Not Applicable
USER MANUAL*	809-DESKTOPUSERMANUAL on A4 paper
USER MANUAL WEB LINK	https://www.globtek.com/pdf/809-DESKTOPUSERMANUAL.jpg

* This specification sheet is considered the user manual for all applications. It is expected that the buyer of this product will use it to formulate their own user manual for their end product and a user manual specifically for the power adapter is not usually required. If a user manual is not specifically listed above then none will be provided with this unit.

If specific packaging is required, this section must specify all requirements and note "no exceptions". If this section does not specify packaging, it is subject to change without notice at GlobTek's discretion.

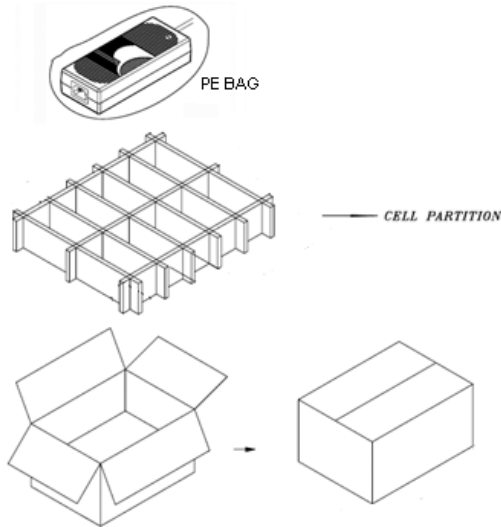

GlobTek, Inc. www.globtek.com 186 Veterans Drive, Northvale, NJ 07647 Tel. (201) 784-1000 Fax (201) 784-0111	Drawing Title: GT-96180-1830-6.0-T3-PP GT-96180-1830-6.0-T3-PP PoE, Passive Power Injector Efficiency Level: USA DOE Level VI / Eco-design Directive 2009/125/EC, (EU) 2019/1782, Case Color/Style: GlobTek Black, Desktop/External Single Port Power Over Ethernet Midspan (IEEE802.3af PoE PSE), Input Rating: 100-240V~, 50-60 Hz IEC 60320/C14 Output Rating: 18.00W, 24.0V@0.75A Pin Out: PoE injector wiring Data, Data+Power, RJ45 x 2	
	Model No. GT-96180-1830-6.0-T3-PP	Part No./Ordering No. GT-96180-1824-T3-PP

INSTRUCTIONS TO THE OEM SYSTEMS ENGINEER

It is the responsibility of the OEM systems engineer to provide the end system user instructions and warnings for the use of this product in the end system.

If an input cord is required for this product, AC Mains voltage should be provided to the power supply by a power supply cord approved to the national standards of the country in which it will be used.

This product is not designed to be repaired. No serviceable parts inside. A blown internal fuse is an indication of catastrophic failure of circuit component(s). If a Failure Analysis is required for a failed power supply/battery charger, please return the damaged unit to GlobTek for an accurate determination of the root cause of the failure.

EMC Compliance of the complete OEM product, including the GlobTek power supply/battery charger needs to be verified by the OEM systems engineer.

GlobTek, Inc. www.globtek.com 186 Veterans Drive, Northvale, NJ 07647 Tel. (201) 784-1000 Fax (201) 784-0111	Drawing Title: GT-96180-1830-6.0-T3-PP GT-96180-1830-6.0-T3-PP PoE, Passive Power Injector Efficiency Level: USA DOE Level VI / Eco-design Directive 2009/125/EC, (EU) 2019/1782, Case Color/Style: GlobTek Black, Desktop/External Single Port Power Over Ethernet Midspan (IEEE802.3af PoE PSE), Input Rating: 100-240V~, 50-60 Hz IEC 60320/C14 Output Rating: 18.00W, 24.0V@0.75A Pin Out: PoE injector wiring Data, Data+Power, RJ45 x 2	
	Model No. GT-96180-1830-6.0-T3-PP	
	Part No./Ordering No. GT-96180-1824-T3-PP	Rev C

INSTRUCTION SHEET

N/A

GlobTek, Inc. www.globtek.com 186 Veterans Drive, Northvale, NJ 07647 Tel. (201) 784-1000 Fax (201) 784-0111	Drawing Title: GT-96180-1830-6.0-T3-PP GT-96180-1830-6.0-T3-PP PoE, Passive Power Injector Efficiency Level: USA DOE Level VI / Eco-design Directive 2009/125/EC, (EU) 2019/1782, Case Color/Style: GlobTek Black, Desktop/External Single Port Power Over Ethernet Midspan (IEEE802.3af PoE PSE), Input Rating: 100-240V~, 50-60 Hz IEC 60320/C14 Output Rating: 18.00W, 24.0V@0.75A Pin Out: PoE injector wiring Data, Data+Power, RJ45 x 2	
	Model No. GT-96180-1830-6.0-T3-PP	Part No./Ordering No. GT-96180-1824-T3-PP

TERMS AND CONDITIONS

THESE TERMS AND CONDITIONS GOVERN THE SALE OF ALL PRODUCTS AND SERVICES ("PRODUCTS") BY GlobTek, Inc. ("GlobTek") AND APPLY NOTWITHSTANDING ANY CONFLICTING, CONTRARY OR ADDITIONAL TERMS AND CONDITIONS IN ANY PURCHASE ORDER OR OTHER DOCUMENT OR COMMUNICATION ("PURCHASE ORDER") FROM BUYER. THESE TERMS AND CONDITIONS MAY ONLY BE WAIVED OR MODIFIED IN A WRITTEN AGREEMENT SIGNED BY AN AUTHORIZED REPRESENTATIVE OF THE SELLER. NEITHER SELLER'S ACKNOWLEDGEMENT OF A PURCHASE ORDER NOR SELLER'S FAILURE TO OBJECT TO CONFLICTING, CONTRARY OR ADDITIONAL TERMS AND CONDITIONS IN A PURCHASE ORDER SHALL BE DEEMED AN ACCEPTANCE OF SUCH TERMS AND CONDITIONS OR A WAIVER OF THE PROVISIONS HEREOF.

ORDERS:

1. Buyer must issue a Purchase Order or otherwise place an order by means acceptable to GlobTek. Orders shall identify the Products, unit quantities, part numbers, descriptions, applicable prices, ship to address and requested delivery dates. All orders are subject to acceptance by GlobTek. No order may be cancelled or rescheduled without GlobTek's consent. Consent may be given by GlobTek in its sole discretion. GlobTek reserves the right to add a Rescheduling Fee should Seller deem applicable. Seller reserves the right to allocate sales of Products among its customers in its sole discretion.

RESTOCKING TERMS:

1. Returning of stock items only: All claims must be made within ten (10) days of receipt of goods. GlobTek must authorize all returns. No return of product will be accepted without GlobTek's Return Merchandise Authorization (RMA) number. All authorized returns will be subject to a minimum of 25% restocking charge* and buyer must pay return freight to GlobTek. Parts must be in original condition and packaging.
2. *Custom items and/or dedicated production lots are not returnable.

RETURNED MERCHANDISE:

1. Replacement or credit will not be allowed for products returned without prior consent. No return of product will be accepted without a GlobTek RMA number. RMA requests for all goods that are found to be not in compliance with Seller's specifications shall be made according to Seller's RMA procedure within thirty (30) days of invoice/shipment date and may be replaced, repaired, or credited at GlobTek's option. All RMA claims reported more than thirty (30) days after the invoice/shipment date are not eligible for return, replacement or credit at subject to GlobTek's Terms and Conditions. GlobTek will not issue credit if the Product has been altered, repaired, or opened by persons other than those authorized by GlobTek, become defective due to acts of God or negligence, become defective due to being subjected to abnormal conditions during installation, application or maintenance or if warranty has expired. Acceptance of Buyer's debit will not be made until material has been received and evaluated by the GlobTek. To determine the "Root Cause of Failure", the product may be destroyed during evaluation. If this occurs all of the above Terms and Conditions will remain in effect. All freight costs for returns, both from customer back to GlobTek and GlobTek back to customer will not be borne by GlobTek. GlobTek requires all goods to be returned freight, duty, and taxes prepaid to the location provided in the RMA authorization notification and repaired or replaced goods will be provided

GlobTek, Inc. www.globtek.com 186 Veterans Drive, Northvale, NJ 07647 Tel. (201) 784-1000 Fax (201) 784-0111	Drawing Title: GT-96180-1830-6.0-T3-PP GT-96180-1830-6.0-T3-PP PoE, Passive Power Injector Efficiency Level: USA DOE Level VI / Eco-design Directive 2009/125/EC, (EU) 2019/1782, Case Color/Style: GlobTek Black, Desktop/External Single Port Power Over Ethernet Midspan (IEEE802.3af PoE PSE), Input Rating: 100-240V~, 50-60 Hz IEC 60320/C14 Output Rating: 18.00W, 24.0V@0.75A Pin Out: PoE injector wiring Data, Data+Power, RJ45 x 2	
	Model No. GT-96180-1830-6.0-T3-PP	Part No./Ordering No. GT-96180-1824-T3-PP
		Rev C

on an EX WORKS return location. GlobTek shall not be responsible, under any circumstances, for any rework or modification fee's or costs not previously authorized in writing by GlobTek. If returned goods do not match the quantity or descriptions provided in the RMA application, any non conforming goods will not be qualified for repair, return, or replacement. Goods with illegible date code/serial # information may not be eligible for repair, return, replacement

PRICES/TAXES/TARIFFS:

- Prices shall be as specified by Seller and shall be applicable for the period specified in GlobTek's quote. If no period is specified, prices shall be applicable for thirty (30) days. Notwithstanding the foregoing, prices shall be subject to increase in the event of an increase in GlobTek's costs or other circumstances beyond GlobTek's reasonable control. Prices are exclusive of taxes, impositions, tariffs, fees, and other charges, including, without limitation, sales, use, excise, value added, and ad valorem taxes, as well as tariffs of all types (including any tariffs imposed pursuant to any Section 301 Action by the United States Trade Representative) and similar taxes, fees, imposts, or charges of whatsoever kind, imposed now or in the future by any foreign or domestic governmental authority, international shipping charges, forwarding agent's and broker's fees, consular fees, document fees and import duties. If GlobTek shall be liable to collect and/or pay, or if the GlobTek shall pay, any of the foregoing, Buyer shall pay same to GlobTek in addition to the price of the Products.

TERMS OF PAYMENT:

- Payment shall be net thirty (30) days from date of invoice or as otherwise specified by GlobTek. Buyer agrees to pay the entire net amount of each invoice from Seller pursuant to the terms of each such invoice without offset or deduction. Orders are subject to credit approval by GlobTek, which may in its sole discretion at any time change the terms of Buyer's credit, require payment in cash, bank wire transfer, or by official bank check and/or require payment of any or all amounts due or to become due for Buyer's order before shipment of any or any of the Products. If GlobTek believes in good faith that Buyer's ability to make payments may be impaired or if Buyer shall fail to pay any invoice when due, GlobTek may suspend delivery of any order or any remaining balance thereof until such payment is made or cancel any order or any remaining balance thereof, and Buyer shall remain liable to pay for any Products already shipped and all Products ordered by Buyer. Buyer agrees to submit such financial information from time to time as may be reasonably requested by GlobTek for the establishment and/or continuation of credit terms. Checks are accepted subject to collection and the date of collection shall be deemed the date of payment. Any check received from Buyer may be applied by GlobTek against any obligation owing from Buyer to GlobTek, regardless of any statement appearing on or referring to such check, without discharging Buyer's liability for any additional amounts owing from Buyer to GlobTek, and the acceptance by GlobTek of such check shall not constitute a waiver of GlobTek's right to pursue the collection of any remaining balance. Buyer shall pay interest on any invoice not paid when due according to the due date at the rate of eighteen (18%) percent annually or the highest rate allowable by law. If Buyer fails to make payment when due, GlobTek may pursue any legal or equitable remedies, in which event GlobTek shall be entitled to reimbursement for costs of collection and reasonable attorneys fees.

REFUSED OR DAMAGED SHIPMENTS:

- All products returned to GlobTek due to refusal of acceptance by buyer, without GlobTek authorization, will be subject to minimum of 25% restocking charge* and buyer must pay return freight to GlobTek. Parts must be in original condition and packaging. Seller takes extra precautions to insure that shipments are made under the Highest Quality Standards. In the event a

GlobTek, Inc. www.globtek.com 186 Veterans Drive, Northvale, NJ 07647 Tel. (201) 784-1000 Fax (201) 784-0111	Drawing Title: GT-96180-1830-6.0-T3-PP GT-96180-1830-6.0-T3-PP PoE, Passive Power Injector Efficiency Level: USA DOE Level VI / Eco-design Directive 2009/125/EC, (EU) 2019/1782, Case Color/Style: GlobTek Black, Desktop/External Single Port Power Over Ethernet Midspan (IEEE802.3af PoE PSE), Input Rating: 100-240V~, 50-60 Hz IEC 60320/C14 Output Rating: 18.00W, 24.0V@0.75A Pin Out: PoE injector wiring Data, Data+Power, RJ45 x 2	
	Model No. GT-96180-1830-6.0-T3-PP	
	Part No./Ordering No. GT-96180-1824-T3-PP	Rev C

shipment is received in damaged condition, Buyer shall contact the carrier to submit claim, keep Products in original boxes pending carrier's inspection and place a replacement order with the Seller.

2. *Custom items and/or dedicated production lots are not returnable.

TECHNICAL ADVICE AND DATA:

1. Any technical advice offered or given in connection with the use of any goods is an accommodation to Buyer without charge and GlobTek shall have no responsibility or liability whatsoever for the content or use of such advice. Without GlobTek's prior written consent, Buyer shall not use, duplicate or disclose any technical data delivered or disclosed by GlobTek to Buyer for any purposes other than for installation, operation or maintenance of goods purchased by Buyer. Any use made of GlobTek classifications, whether it be ECCNs or any variation of Harmonized Tariff codes, is without recourse to GlobTek and at the user's risk. Export classifications are subject to change. If you export or re-export, your company, as the exporter of record, is responsible for determining the correct classification of any item at the time of export. Any export classification by GlobTek is for GlobTek's internal use only and shall not be construed as a representation or warranty regarding the proper export classification nor relied upon to make licensing determinations.

Tariff Surcharge – Section 301 and Related Import Duties

GlobTek, Inc. hereby notifies all customers that a tariff surcharge fee is applied to cover import duties and tariffs, including but not limited to those imposed under Section 301 of the U.S. Trade Act of 1974, affecting Chinese-origin goods imported into the United States between 2018 and 2025.

Customers receiving delivery from U.S.-based shipping points were and are informed of the tariff surcharge:

- At the time of quotation;
- During order entry; and
- Through routine updates issued during the order process.

Due to the volatility of tariff rates and ongoing changes in U.S. trade policy, GlobTek reserves the right to adjust the tariff surcharge fee:

- To match the current applicable tariff rates, or
- To reflect the maximum applicable tariff rate assessed on the product(s) in question, depending on the date of importation into the U.S.

By placing an order with GlobTek for goods that are produced in china built to order and imported from China, the customer expressly acknowledges and agrees to pay the applicable tariff surcharge fee. This surcharge is non-negotiable and is considered a part of the total purchase price for applicable transactions.

GlobTek, Inc. www.globtek.com 186 Veterans Drive, Northvale, NJ 07647 Tel. (201) 784-1000 Fax (201) 784-0111	Drawing Title: GT-96180-1830-6.0-T3-PP GT-96180-1830-6.0-T3-PP PoE, Passive Power Injector Efficiency Level: USA DOE Level VI / Eco-design Directive 2009/125/EC, (EU) 2019/1782, Case Color/Style: GlobTek Black, Desktop/External Single Port Power Over Ethernet Midspan (IEEE802.3af PoE PSE), Input Rating: 100-240V~, 50-60 Hz IEC 60320/C14 Output Rating: 18.00W, 24.0V@0.75A Pin Out: PoE injector wiring Data, Data+Power, RJ45 x 2	
	Model No. GT-96180-1830-6.0-T3-PP	
	Part No./Ordering No. GT-96180-1824-T3-PP	Rev C

FORCE MAJEURE:

1. GlobTek shall not be liable for failure to fulfill the obligations herein or for delays in delivery due to causes beyond its reasonable control, including, but not limited to, acts of God, natural disasters, acts or omissions of other parties acts or omissions of civil or military authority, Government priorities, changes in law, material shortages, fire, strikes, floods, epidemics, quarantine restrictions, riots, war, acts of terrorism, delays in transportation or inability to obtain labor or materials through its regular sources. GlobTek's time for performance of any such obligation shall be extended for the time period of such delay or GlobTek may, at its option cancel any order or remaining part thereof without liability, advising in writing notice of such cancellation to Buyer.

LIMITATION OF LIABILITIES:

1. BUYER SHALL NOT IN ANY EVENT BE ENTITLED TO, AND SELLER SHALL NOT BE LIABLE FOR INDIRECT, SPECIAL, INCIDENTAL OR CONSEQUENTIAL DAMAGES OF ANY NATURE INCLUDING, WITHOUT LIMITATION BUSINESS INTERRUPTION COSTS, REMOVAL AND/OR REINSTALLATION COSTS, REPROCUREMENT COSTS, LOSS OF PROFIT OR REVENUE, LOSS OF DATA, PROMOTIONAL OR MANUFACTURING EXPENSES, OVERHEAD, INJURY TO REPUTATION OR LOSS OF CUSTOMERS, EVEN IF GLOBTEK HAS BEEN ADVISED OF THE POSSIBILITY OF SUCH DAMAGES. BUYER'S RECOVERY FROM SELLER FOR ANY CLAIM SHALL NOT EXCEED BUYER'S PURCHASE PRICE FOR THE PRODUCT GIVING RISE SUCH CLAIM IRRESPECTIVE OF THE NATURE OF THE CLAIM, WHETHER IN CONTRACT, TORT, WARRANTY OR OTHERWISE. GLOBTEK SHALL NOT BE LIABLE FOR AND BUYER SHALL INDEMNIFY, DEFEND AND HOLD GLOBTEK HARMLESS FROM ANY CLAIMS BASED ON GLOBTEK'S COMPLIANCE WITH BUYER'S DESIGNS, SPECIFICATIONS OR INSTRUCTIONS, OR MODIFICATION OF ANY PRODUCTS BY PARTIES OTHER THAN SELLER, OR USE IN COMBINATION WITH OTHER PRODUCTS. GLOBTEK INC. WILL NOT BE LIABLE FOR THE SAFETY AND PERFORMANCE OF THESE PRODUCTS IF UNAUTHORIZED USE, ACCESS AND/OR REPAIR. END USER SHOULD CONSULT APPLICABLE UL, CSA OR EN STANDARDS FOR PROPER INSTALLATION INSTRUCTIONS. GLOBTEK PRODUCTS ARE NOT AUTHORIZED FOR USE AS MISSION CRITICAL COMPONENTS IN LIFE SUPPORT, HAZARDOUS ENVIRONMENT, NUCLEAR OR AIRCRAFT APPLICATIONS WITHOUT PRIOR WRITTEN APPROVAL FROM THE CEO OF GLOBTEK INC. CONTENTS OF GLOBTEK SPECIFICATIONS ARE SUBJECT TO CHANGE WITHOUT PRIOR NOTICE.

GENERAL:

1. As used herein, terms appearing in the singular shall include the plural and terms appearing in the plural shall include singular. No rights, duties, agreements or obligations hereunder may be assigned or transferred by either party, by operation of law, merger or otherwise, without the prior written consent of the other. Any attempted or purported assignment shall be void. Notwithstanding the foregoing, GlobTek's obligations under these Terms and Conditions may be performed by divisions, subsidiaries or affiliates of GlobTek. The obligations, rights, terms and conditions hereof shall be binding on the parties hereto and their respective successors and assigns. The waiver of any provision hereof or of any breach or default hereunder shall not be deemed a waiver of any other provision hereof or breach or default hereunder. Any provision hereof which is prohibited or

GlobTek, Inc. www.globtek.com 186 Veterans Drive, Northvale, NJ 07647 Tel. (201) 784-1000 Fax (201) 784-0111	Drawing Title: GT-96180-1830-6.0-T3-PP GT-96180-1830-6.0-T3-PP PoE, Passive Power Injector Efficiency Level: USA DOE Level VI / Eco-design Directive 2009/125/EC, (EU) 2019/1782, Case Color/Style: GlobTek Black, Desktop/External Single Port Power Over Ethernet Midspan (IEEE802.3af PoE PSE), Input Rating: 100-240V~, 50-60 Hz IEC 60320/C14 Output Rating: 18.00W, 24.0V@0.75A Pin Out: PoE injector wiring Data, Data+Power, RJ45 x 2	
	Model No. GT-96180-1830-6.0-T3-PP	
	Part No./Ordering No. GT-96180-1824-T3-PP	Rev C

unenforceable in any jurisdiction shall, as to such jurisdiction, be ineffective to the extent of such prohibition or unenforceability without invalidating the remaining provisions hereof in that jurisdiction or affecting the validity or enforceability of such provision in any other jurisdiction. These Terms and Conditions shall be governed by and construed in accordance with the laws of the State of New Jersey, United States, excluding any law or principle, which would apply the law of any other jurisdiction. The United Nations Convention on contracts for the International Sale of Goods shall not apply to these Terms.

LIMITED WARRANTIES:

- GLOBTEK'S POWER SUPPLIES ARE BUILT WITH PRIDE BY PROFESSIONALS DEDICATED TO UNCOMPROMISING QUALITY AND RELIABILITY. YOUR COMPLETE SATISFACTION WITH OUR PRODUCTS IS OUR PARAMOUNT OBJECTIVE. IF GLOBTEK IS GIVEN NOTICE OF A DEFECT IN MATERIALS OR WORKMANSHIP OCCURRING WITHIN FIVE (5) YEARS FROM THE DATE OF SHIPMENT BY GLOBTEK, THEN GLOBTEK SHALL, AT ITS SOLE OPTION: 1) REPAIR OR REPLACE THE DEFECTIVE PART(S) OR PRODUCT(S) OR 2) REFUND THE ORIGINAL PURCHASE PRICE, BOTH SUBJECT TO THE FOLLOWING PROVISIONS OF THIS PARAGRAPH. THIS WARRANTY ONLY EXTENDS TO POWER SUPPLIES, ELECTRICAL ASSEMBLIES AND POWER CABLES MADE BY GLOBTEK. THIS WARRANTY DOES NOT EXTEND TO ANY AND ALL BATTERY CELLS, OR TO BRANDED CONNECTOR ITEMS, CUSTOMER SPECIFIED ITEMS FROM OTHER MANUFACTURERS, CUSTOMER SUPPLIED MATERIALS, OR DEFECTS RESULTING FROM CUSTOMER SUPPLIED MATERIALS. DEFECTS RESULTING FROM CUSTOMER SUPPLIED MATERIALS WILL NULLIFY THIS WARRANTY. THIS WARRANTY ALSO DOES NOT EXTEND TO PRODUCTS WHICH HAVE BEEN OPENED, ALTERED OR REPAIRED BY PERSONS OTHER THAN PERSONS AUTHORIZED BY THE MANUFACTURER OR TO PRODUCTS WHICH BECOME DEFECTIVE DUE TO ACTS OF GOD AND OTHER ACTS CONSTITUTING FORCE MAJEURE AS DEFINED IN SECTION 8 ABOVE, NEGLIGENCE OR THE FAILURE OF THE USER TO FULLY FOLLOW INSTRUCTIONS WITH RESPECT TO INSTALLATION, APPLICATION OR MAINTENANCE. THIS WARRANTY DOES NOT EXTEND TO PRODUCTS WHICH HAVE BEEN SUBJECT TO ABNORMAL USE, ABNORMAL CONDITIONS, IMPROPER STORAGE, SPILLAGE OF LIQUIDS, MISUSE, NEGLIGENCE, EXPOSURE TO CLEANING AGENTS NOT RECOMMENDED BY THE MANUFACTURER, OR OTHER ACTS WHICH ARE NOT THE FAULT OF GLOBTEK. THIS WARRANTY DOES NOT COVER ORDINARY WEAR AND TEAR, DEFECTS IN APPEARANCE, COSMETIC, DECORATIVE OR STRUCTURAL ITEMS OR NON-OPERATIVE PARTS. WITH REGARD TO BATTERY CELLS, OR TO BRANDED CONNECTOR ITEMS, CUSTOMER SPECIFIED ITEMS FROM OTHER MANUFACTURERS, AND CUSTOMER SUPPLIED MATERIALS, THE BUYER IS REFERRED TO THE MANUFACTURER'S WARRANTY, IF ANY. FOR RECHARGEABLE BATTERY PACK PRODUCTS, ANY CLAIM FOR WARRANTY MUST BE SUPPORTED BY AUDITABLE EVIDENCE OF PROPER USE, HANDLING, AND MAINTENANCE ACCORDING TO GLOBTEK AND CELL MANUFACTURER SPECIFICATIONS. THIS WARRANTY IS NOT A WARRANTY OF FUTURE PERFORMANCE. IN ORDER TO EXERCISE THE BUYER'S REMEDY FOR BREACH OF THIS LIMITED WARRANTY, GLOBTEK MUST BE GIVEN WRITTEN NOTICE OF A DEFECT IN MATERIALS OR WORKMANSHIP WITHIN FIVE (5) YEARS OF THE DATE OF SHIPMENT. FURTHER, GLOBTEK'S INSPECTION ESTABLISHES THE EXISTENCE OF A DEFECT. PACKAGING, FREIGHT, INSURANCE AND OTHER CHARGES INCURRED IN RETURNING THE DEFECTIVE PRODUCTS TO WILL BE PAID BY THE BUYER. IF THE BUYER FAILS TO FULLY COMPLY WITH THE FOREGOING, BUYER SHALL NOT BE ENTITLED TO ANY ALLOWANCE OR CLAIM WITH RESPECT TO SUCH PRODUCT. THE BUYER AGREES THAT NO OTHER REMEDY (INCLUDING, BUT NOT LIMITED TO, INCIDENTAL OR CONSEQUENTIAL DAMAGES FOR LOST PROFITS, LOST SALES, INJURY TO PERSON OR PROPERTY OR ANY OTHER INCIDENTAL OR CONSEQUENTIAL LOSSES) SHALL BE AVAILABLE TO THE BUYER.

GlobTek, Inc. www.globtek.com 186 Veterans Drive, Northvale, NJ 07647 Tel. (201) 784-1000 Fax (201) 784-0111	Drawing Title: GT-96180-1830-6.0-T3-PP GT-96180-1830-6.0-T3-PP PoE, Passive Power Injector Efficiency Level: USA DOE Level VI / Eco-design Directive 2009/125/EC, (EU) 2019/1782, Case Color/Style: GlobTek Black, Desktop/External Single Port Power Over Ethernet Midspan (IEEE802.3af PoE PSE), Input Rating: 100-240V~, 50-60 Hz IEC 60320/C14 Output Rating: 18.00W, 24.0V@0.75A Pin Out: PoE injector wiring Data, Data+Power, RJ45 x 2	
	Model No. GT-96180-1830-6.0-T3-PP	
	Part No./Ordering No. GT-96180-1824-T3-PP	Rev C

2. EXCEPT FOR THE FOREGOING EXPRESS LIMITED WARRANTY, GLOBTEK MAKES NO WARRANTY, EXPRESS OR IMPLIED, INCLUDING, BUT NOT LIMITED TO, THE WARRANTIES OF MERCHANTABILITY AND FITNESS FOR A PARTICULAR PURPOSE, ALL OF WHICH IMPLIED WARRANTIES ARE HEREBY SPECIFICALLY DISCLAIMED.