

SERIES: SDI18-U | **DESCRIPTION:** AC-DC POWER SUPPLY

FEATURES

- up to 18 W continuous power
- DoE Level VI, CoC Tier 2 efficiency
- no load power consumption < 0.075 W
- compact size
- universal input voltage range
- over voltage, over current, and short circuit protections
- UL/cUL, CE, PSE safety approvals
- certified to 62368-1 standards



MODEL	output voltage	output current	output power	ripple and noise ¹	efficiency level ²
	(Vdc)	max (A)	max (W)	max (mVp-p)	
SDI18-5-U	5	3	15	100	VI
SDI18-5.9-U	5.9	3	17.7	100	VI
SDI18-9-U	9	2.2	19.8	100	VI
SDI18-12-U	12	1.6	19.2	120	VI
SDI18-15-U	15	1.3	19.5	150	VI
SDI18-24-U	24	0.8	19.2	240	VI

Notes: 1. At full load, nominal input, 20 MHz bandwidth oscilloscope, each output terminated with 0.1 µF multilayer ceramic and 10 µF low ESR electrolytic capacitors.
2. CoC Tier 2 compliant

PART NUMBER KEY

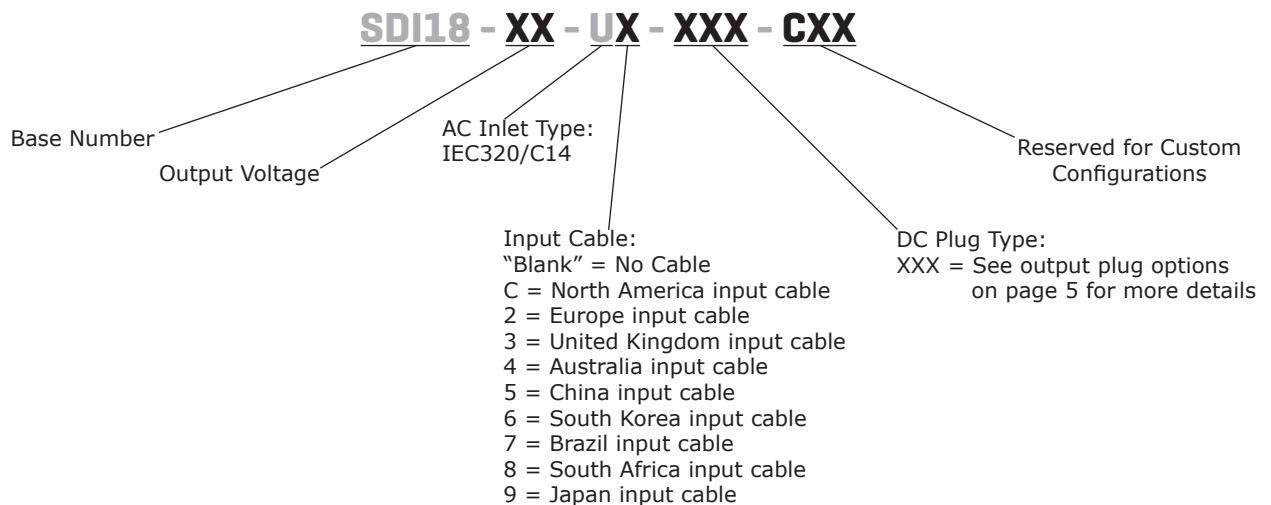

INPUT

parameter	conditions/description	min	typ	max	units
voltage		90		264	Vac
frequency		47		63	Hz
current	at full load			0.48	A
inrush current	at 100 Vac, full load, 25°C, cold start			50	A
	at 230 Vac, full load, 25°C, cold start			60	A
leakage current				3.5	mA
no load power consumption	at 230 Vac			0.075	W

OUTPUT

parameter	conditions/description	min	typ	max	units
regulation	5 Vdc output model		±6		%
	all other models		±5		%
hold-up time	at full load	10			ms

PROTECTIONS

parameter	conditions/description	min	typ	max	units
over voltage protection	output shut down				
	5 Vdc output model			12	Vdc
	5.9 Vdc output model			12	Vdc
	9 Vdc output model			16	Vdc
	12 Vdc output model			22	Vdc
	15 Vdc output model			32	Vdc
over current protection	24 Vdc output model			45	Vdc
	output shut down, auto recovery				
	5 Vdc output model			7	A
	5.9 Vdc output model			6	A
	9 Vdc output model			5	A
	12 Vdc output model			5	A
short circuit protection	15 Vdc output model			4	A
	24 Vdc output model			2.5	A
	output shut down, auto recovery				
	output shut down, auto recovery				

SAFETY & COMPLIANCE

parameter	conditions/description	min	typ	max	units
isolation voltage	input to output at 10 mA for 1 minute		3,000		Vac
	input to frame ground at 10 mA for 1 minute		1,500		Vac
isolation resistance	input to output at 500 Vdc	10			MΩ
	input to frame ground at 500 Vdc	10			MΩ
safety approvals	UL/cUL (62368-1), PSE, UKCA				
EMI/EMC	FCC Part 15B Class B, CE				
MTBF	as per Telcordia SR-332, 25°C	300,000			hours
RoHS	yes				

ENVIRONMENTAL

parameter	conditions/description	min	typ	max	units
operating temperature		0		40	°C
storage temperature		-20		80	°C
operating humidity	non-condensing	20		80	%
storage humidity	non-condensing	10		90	%

MECHANICAL

parameter	conditions/description	min	typ	max	units
dimensions	100 x 50 x 33				mm
inlet plug	IEC320/C14				
weight	without ac cord		170		g

MECHANICAL DRAWING

units: mm
tolerance: ±1.0 mm

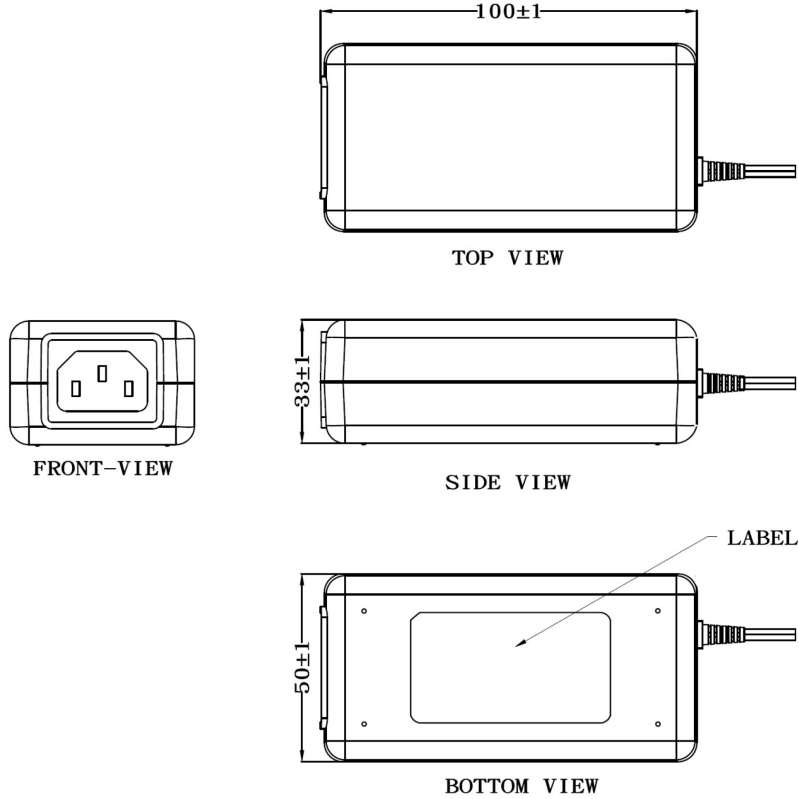

DC CORD

units: mm

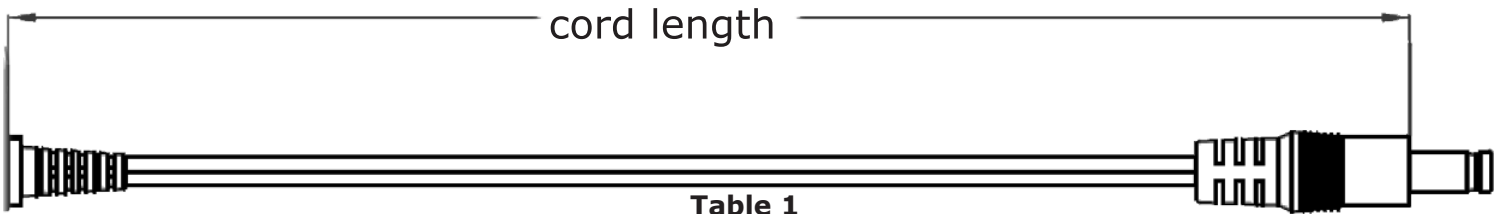
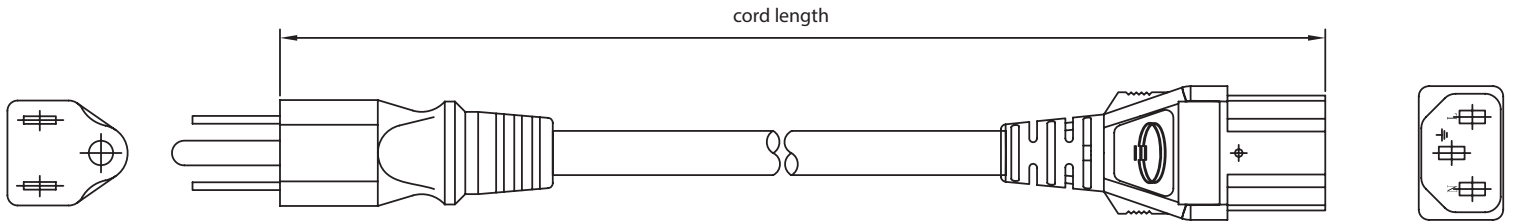

Table 1

MODEL NO.	CABLE	CORD LENGTH
SDI18-5-U	UL2468, 16 AWG	1,500 mm ±30
SDI18-5.9-U	UL2468, 16 AWG	1,200 mm ±30
SDI18-9-U	UL2468, 18 AWG	1,500 mm ±30
SDI18-12-U	UL2468, 20 AWG	1,500 mm ±30
SDI18-15-U	UL2468, 22 AWG	1,500 mm ±30
SDI18-24-U	UL2468, 22 AWG	1,500 mm ±30

AC CORD

units: mm



NORTH AMERICA

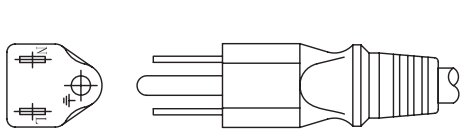

EUROPE

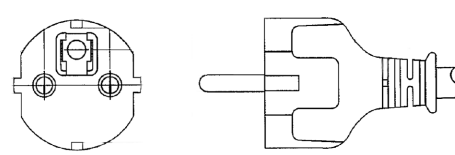

UNITED KINGDOM

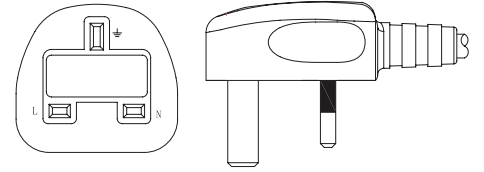

AUSTRALIA

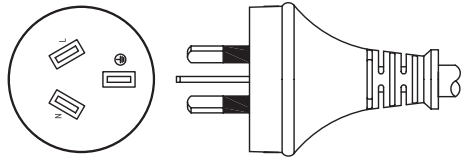

CHINA

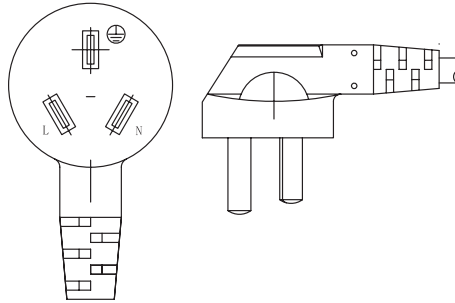

SOUTH KOREA

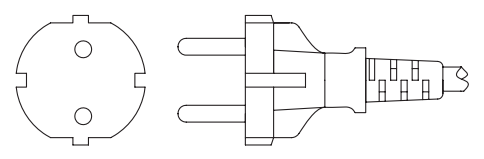

BRAZIL

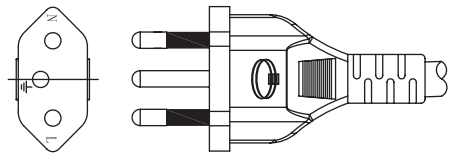

SOUTH AFRICA

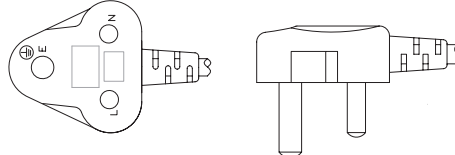

JAPAN

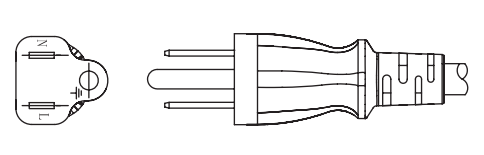
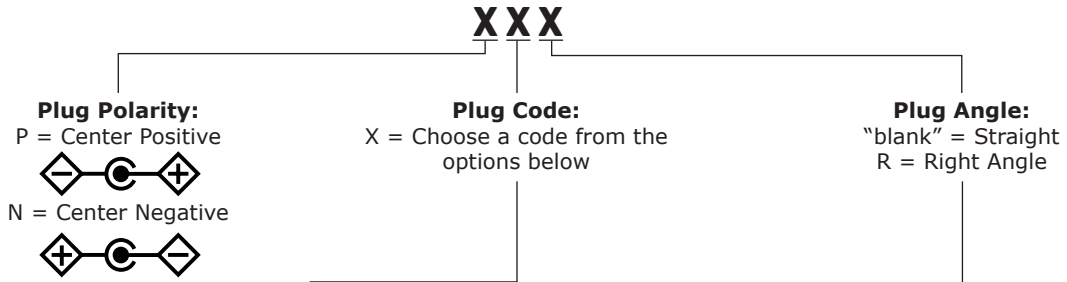

Table 2

AC INPUT	CORD LENGTH
North America	1,830 mm ±30
Europe	1,830 mm ±30
United Kingdom	1,830 mm ±30
Australia	1,830 mm ±30
China	1,830 mm ±30
South Korea	1,830 mm ±50
Brazil	1,830 mm ±30
South Africa	1,830 mm ±50
Japan	1,830 mm ±30

DC PLUG TYPE PART NUMBER KEY



Plug Polarity		Code		Dimensions (mm)			Plug Angle	
Center Pos.	Center Neg.	Option	Type	A	B	C	Straight	Right
•	•	5	Standard	5.5	2.1	9.5	•	•
•	•	6	Standard	5.5	2.5	9.5	•	•
•	•	7	Standard	3.5	1.35	9.5	•	•
•	•	8	Standard	3.8	1.35	9.5	•	•
•	•	9	Standard	3.8	1.05	9.5	•	•
•	•	10	Locking ²	5.5	2.1	9.5	•	N/A
•	•	11	Locking ²	5.5	2.5	9.5	•	N/A
•	•	12	EIAJ-1	2.35	0.7	9.5	•	•
•	•	13	EIAJ-2	4.0	1.7	9.5	•	•
•	•	14	EIAJ-3	4.75	1.7	9.5	•	•
N/A	N/A	ST	Stripped & Tinned			N/A	N/A	

Note: 1. Contact CUI for additional plug options
 2. Maximum insertion depth is 10mm

Standard

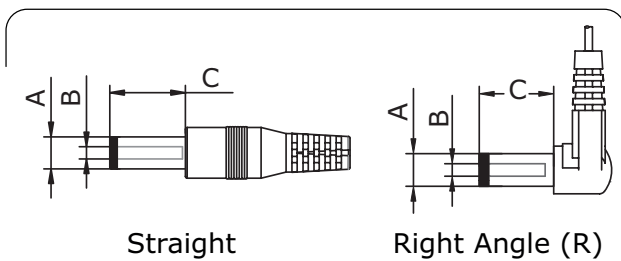

EIAJ

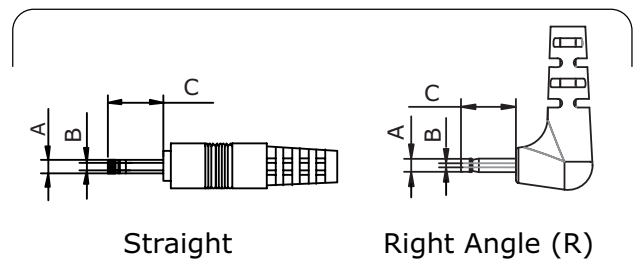

Locking

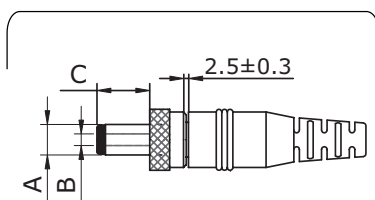

Stripped & Tinned

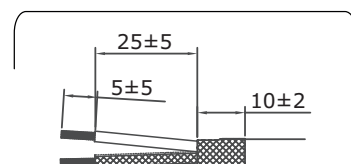

REVISION HISTORY

rev.	description	date
1.0	initial release	08/07/2015
1.01	updated datasheet	03/16/2016
1.02	changed wire gauge on 5 Vdc & 5.9 Vdc models, updated datasheet	09/15/2016
1.03	added 62368-1 standard	08/31/2018
1.04	company logo updated	06/24/2020
1.05	GS removed from safeties	12/09/2020
1.06	tolerance updated in mechanical drawing, UKCA added to specification	08/11/2021
1.07	plug polarity symbols updated	09/16/2021
1.08	LPS added to safety marks, safeties updated	02/18/2022
1.09	dc plugs updated	05/23/2022
1.10	safeties updated	04/24/2023

The revision history provided is for informational purposes only and is believed to be accurate.



Headquarters
20050 SW 112th Ave.
Tualatin, OR 97062
800.275.4899

Fax 503.612.2383
cui.com
techsupport@cui.com

This device complies with part 15 of the FCC Rules. Operation is subject to the following two conditions:

- (1) This device may not cause harmful interference, and
- (2) this device must accept any interference received, including interference that may cause undesired operation.

CUI offers a one (1) year limited warranty. Complete warranty information is listed on our website.

CUI reserves the right to make changes to the product at any time without notice. Information provided by CUI is believed to be accurate and reliable. However, no responsibility is assumed by CUI for its use, nor for any infringements of patents or other rights of third parties which may result from its use.

CUI products are not authorized or warranted for use as critical components in equipment that requires an extremely high level of reliability. A critical component is any component of a life support device or system whose failure to perform can be reasonably expected to cause the failure of the life support device or system, or to affect its safety or effectiveness.