

Features

Unregulated Converters

- Pot-core transformer - separated windings
- High 5.2kVDC/1s isolation in compact size
- Optional continuous short circuit protection
- Efficiency up to 85%
- Pin compatible with RH and RK series
- Suitable for IGBT applications
- IEC/EN/UL/CSA 60950-1 certified

RECOM

DC/DC Converter

RP

1 Watt SIP7 Single and Dual Output



Description

The RP series has very high isolation of 5.2kVDC in a compact size. The converters are suitable for IGBT driver applications. The /X2 version has rearranged pins to permit an input output separation of more than 9mm.

Selection Guide

Part Number	nom. Input Voltage [VDC]	Output Voltage [VDC]	Output Current [mA]	Efficiency typ. ⁽¹⁾ [%]	max. Capacitive Load ⁽²⁾ [µF]
RP-xx3.3S ^(3,4)	5, 9, 12, 15, 24	3.3	303	70	2200
RP-xx05S ^(3,4)	5, 9, 12, 15, 24	5	200	70-72	1000
RP-xx09S ^(3,4)	5, 9, 12, 15, 24	9	111	75	1000
RP-xx12S ^(3,4)	5, 9, 12, 15, 24	12	84	75-78	470
RP-xx15S ^(3,4)	5, 9, 12, 15, 24	15	66	80	470
RP-xx24S ^(3,4)	5, 9, 12, 15, 24	24	42	80	220
RP-xx3.3D ⁽³⁾	5, 9, 12, 15, 24	±3.3	±152	70	±1000
RP-xx05D ⁽³⁾	5, 9, 12, 15, 24	±5	±100	74-76	±470
RP-xx09D ⁽³⁾	5, 9, 12, 15, 24	±9	±56	75	±470
RP-xx12D ⁽³⁾	5, 9, 12, 15, 24	±12	±42	79-82	±220
RP-xx15D ⁽³⁾	5, 9, 12, 15, 24	±15	±33	80-82	±220
RP-xx24D ⁽³⁾	5, 9, 12, 15, 24	±24	±21	80	±100
RP-xx1509D	5, 12, 24	+15/-9	±42	70-85	±220

Notes:

- Note1: Efficiency is tested at nominal input and full load at +25°C ambient
 Note2: Max Cap Load is tested at nominal input and full resistive load

Model Numbering



Notes:

- Note3: standard part is without continuous short circuit protection
 add suffix „/P“ for continuous short circuit protection
 Note4: add suffix „/X2“ for alternative pinning (only available for single outputs)
 or add suffix „/P/X2“ for continuous short circuit protection and alternative pinning

Ordering Examples:

- RP-123.3S/P: 12V Input Voltage, 3.3V Output Voltage, Single Output with continuous short circuit protection
 RP-0509S/X2: 5V Input Voltage, ±9V Output Voltage, Single Output with alternative pinning
 RP-0505S/P/X2: 5V Input Voltage, 5V Output Voltage, Single Output with continuous short circuit protection and alternative pinning

UL60950-1 certified*
 CSA/CAN C22.2 No. 60950-1-07 certified*
 IEC/EN60950-1 certified
 EN55032 compliant

*+15/-9 version excluded

PREFERRED ALTERNATIVES

For new medical applications:

REM1



Specifications (measured @ Ta= 25°C, nom. Vin and full load unless otherwise stated)

BASIC CHARACTERISTICS

Parameter	Condition	Min.	Typ.	Max.
Internal Input Filter				capacitor
Input Voltage Range			±10%	
Minimum Load		0%		
Start-up time				250ms
Internal Operating Frequency		50kHz	100kHz	120kHz
Output Ripple and Noise	20MHz BW, tested with 0.1µF MLCC across output			100mVp-p

Efficiency vs. Load

RP-xx05S

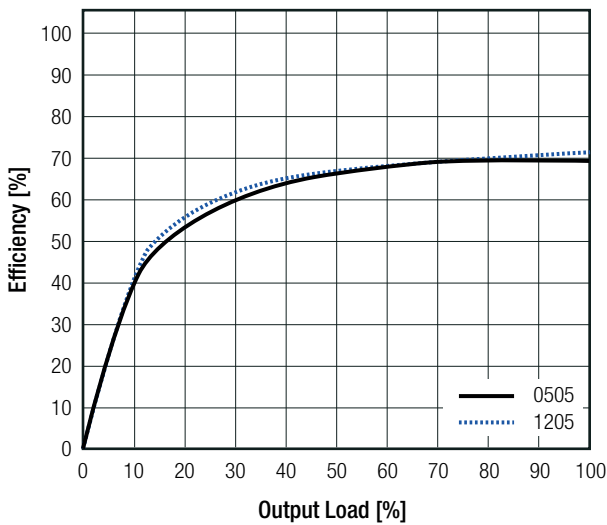

RP-xx12S

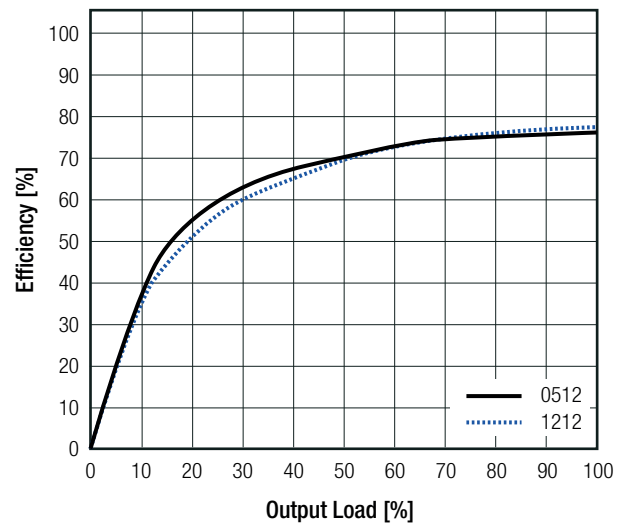

RP-xx15S

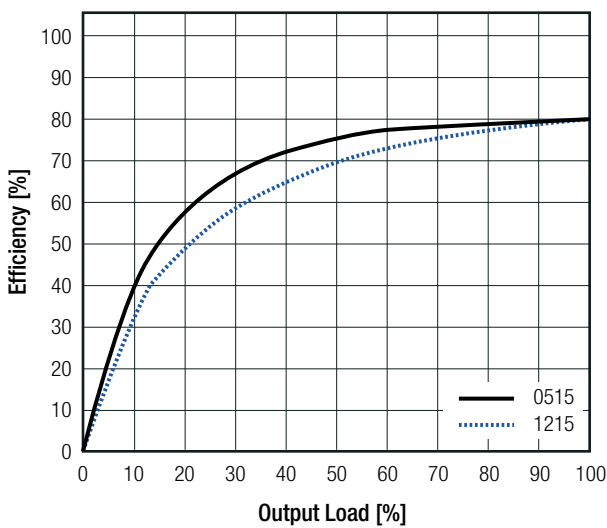

RP-xx05D

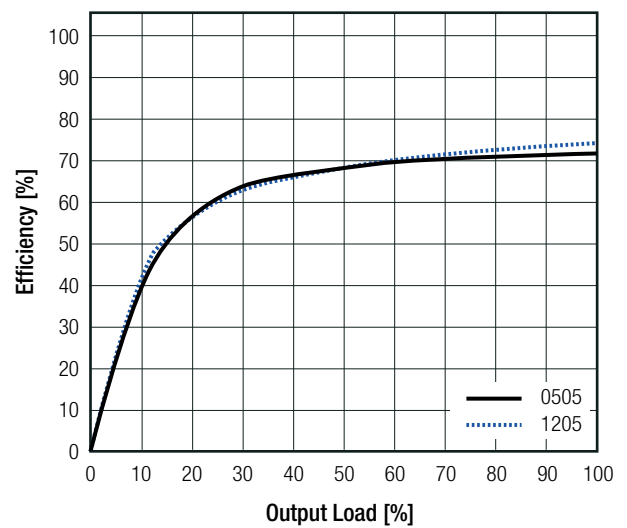

continued on next page

Specifications (measured @ Ta= 25°C, nom. Vin and full load unless otherwise stated)

Efficiency vs. Load

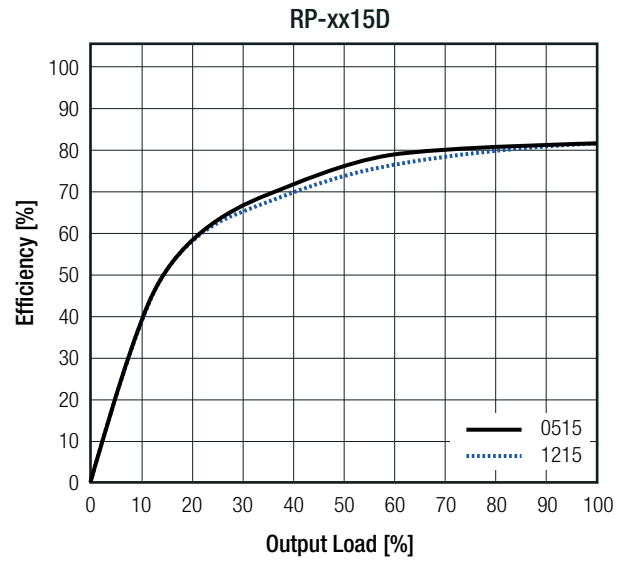
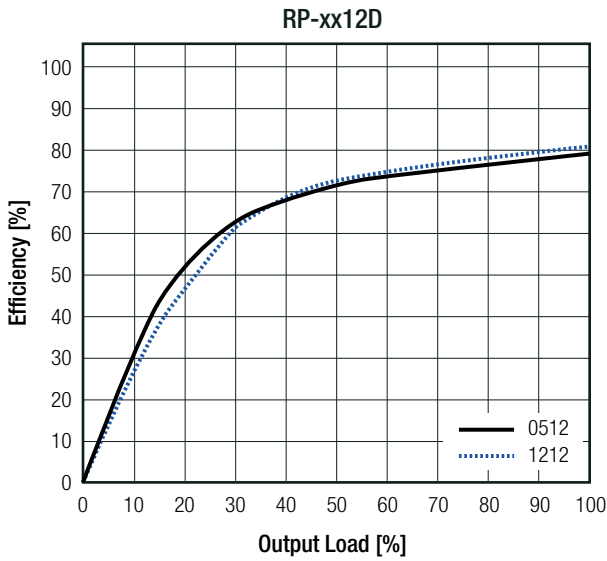

REGULATIONS

Parameter	Condition		Value
Output Accuracy			±5.0% max.
Line Regulation	low line to high line		±1.2% of 1.0% Vin typ.
Load Regulation ⁽⁵⁾	10% to 100% load	3.3Vout	20.0% max.
		5Vout	15.0% max.
		9, 12, 15, 24Vout and RP-xx1509D	10.0% max.

Notes:

Note5: Operation below 10% load will not harm the converter, but specifications may not be met

Deviation vs. Load

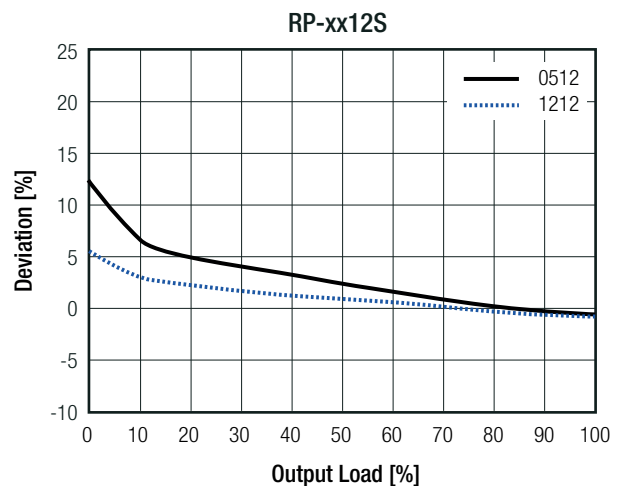
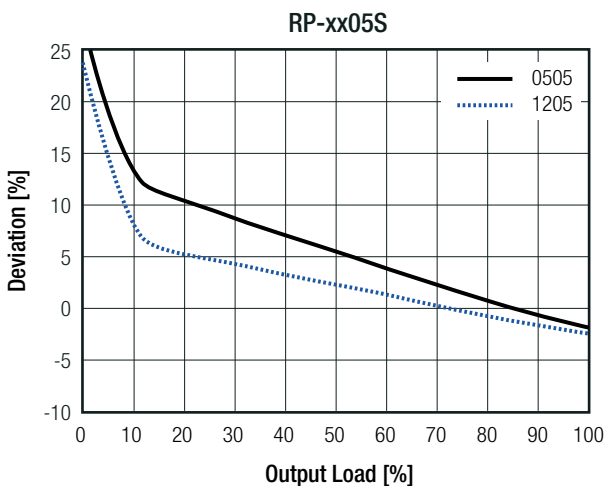

continued on next page

Specifications (measured @ Ta= 25°C, nom. Vin and full load unless otherwise stated)

Deviation vs. Load

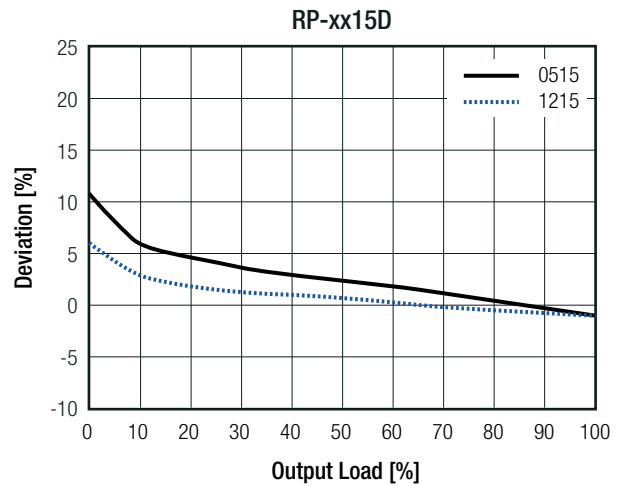
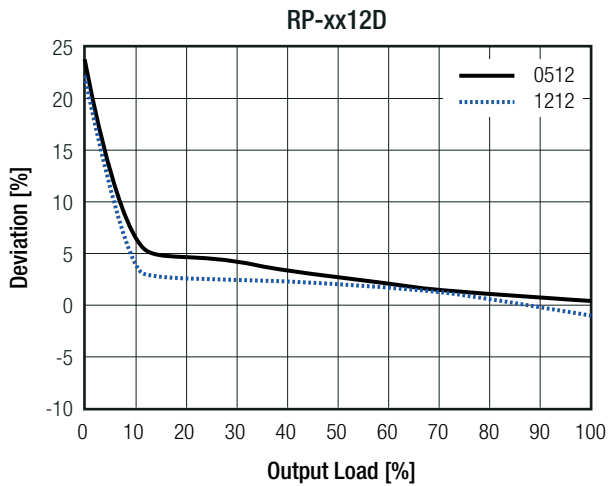
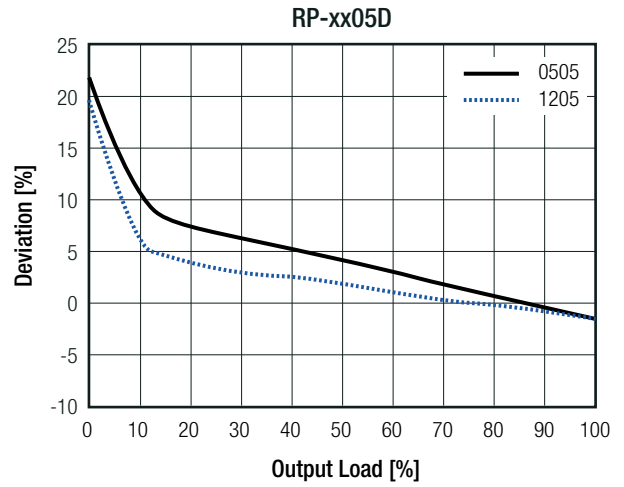
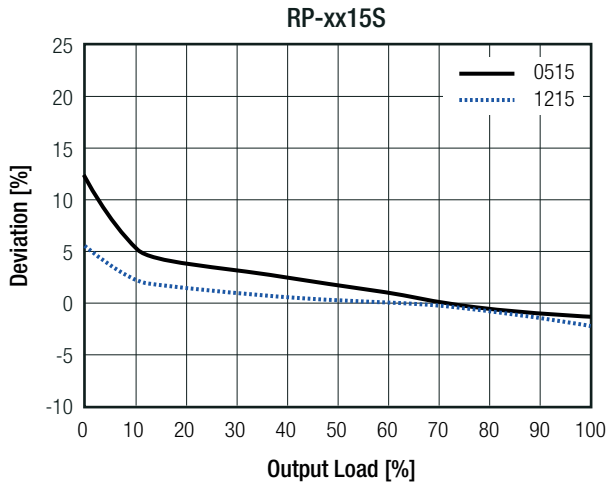

PROTECTIONS

Parameter	Type		Value
Short Circuit Protection (SCP)	without suffix with suffix "/P"		1 second continuous
Isolation Voltage ⁽⁶⁾	I/P to O/P	tested for 1 second rated for 1 minute	5.2kVDC 2kVAC/60Hz
Isolation Resistance			20GΩ min.
Isolation Capacitance			4pF min. / 10pF max.
Insulation Grade	according to 60950-1		basic

Notes:

Note6: For repeat Hi-Pot testing, reduce the time and/or the test voltage

Note7: Refer to local wiring regulations if input over-current protection is also required. Recommended fuse: T1A slow blow type

Specifications (measured @ Ta= 25°C, nom. Vin and full load unless otherwise stated)

ENVIRONMENTAL

Parameter	Condition		Value
Operating Temperature Range	full load (see graph)		-40°C to +85°C
Maximum Case Temperature			+105°C
Operating Altitude			3000m
Operating Humidity	non-condensing		95% RH max.
Pollution Degree			PD2
MTBF	according to MIL-HDBK-217F, G.B.	+25°C	18400 x 10 ³ hours
		+85°C	6900 x 10 ³ hours

Derating Graph

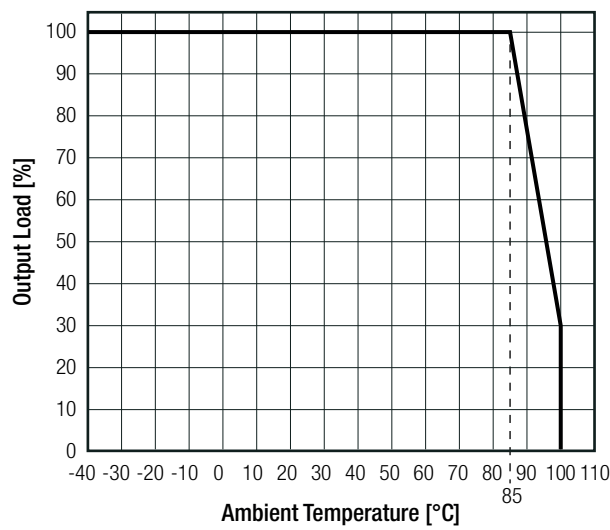

SAFETY AND CERTIFICATIONS

Certificate Type (Safety)	Report / File Number	Standard
Information Technology Equipment, General Requirements for Safety	E358085-A6-UL ^(8,9)	UL60950-1, 2nd Edition:2007 CAN/CSA C22.2 No. 60950-1-03, 2nd Edition:2007
Information Technology Equipment, General Requirements for Safety	SPCLVD1602031 ⁽⁹⁾	IEC60950-1:2005, 2nd Edition + A2:2013 EN60950-1:2006 + A2:2013
Medical electrical equipment Part 1: General requirements for basic safety and essential performance	SPC1007090 ⁽⁸⁾	IEC60601-1:1988 + A2:1995 EN60601-1:1990 + A13 :1996
EAC	RU-AT.49.09571	TP TC 004/2011
RoHS2		RoHS-2011/65/EU + AM-2015/863

EMC Compliance	Condition	Standard / Criterion
Electromagnetic compatibility of multimedia equipment - Emission requirements	with external filter (see filter suggestion below)	EN55032, Class B EN55032, Class A

Notes:

- Note8: excluded +15/-9 version
- Note9: excluded suffix „/X2“

continued on next page

Specifications (measured @ Ta= 25°C, nom. Vin and full load unless otherwise stated)

EMC Filter Suggestion according to EN55032

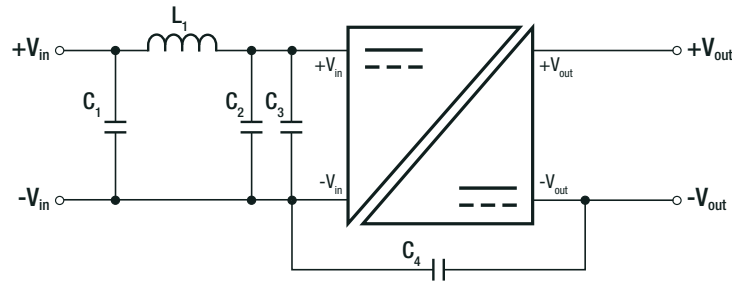

Component List Class A

MODEL	C2	C3
RP-0505S	10µF	4.7µF
RP-0515S		
RP-2405S	100V MLCC	50V MLCC
RP-2424S		

Component List Class B

MODEL	C1	L1	C4 (safety)
RP-0505S	10µF	22µH choke	2.2nF
RP-0515S			
RP-2405S	100V MLCC	RLS-226	
RP-2424S			

Notes:

Note10: Filter suggestions are valid for indicated part numbers only. For other part numbers, please contact RECOM tech support for advice

DIMENSION AND PHYSICAL CHARACTERISTICS

Parameter	Type	Value
Material	case potting PCB	non-conductive black plastic (UL94 V-0) epoxy, (UL94 V-0) FR4, (UL94 V-0)
Dimension (LxWxH)		19.65 x 7.05 x 10.2mm
Weight		2.4g typ.

Dimension Drawing (mm)

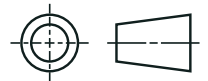
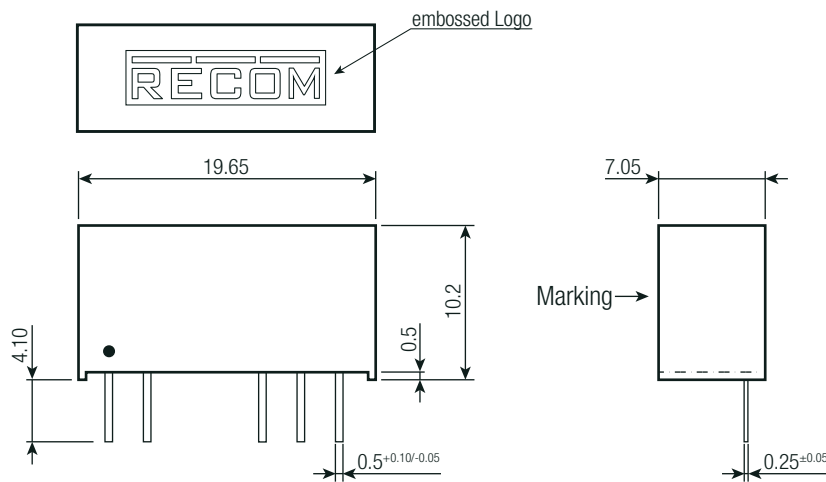

Pinning information

Pin #	Single	Dual	/X2
1	+Vin	+Vin	+Vin
2	-Vin	-Vin	-Vin
5	-Vout	-Vout	no Pin
6	no pin	Com	-Vout
7	+Vout	+Vout	+Vout

Tolerance: xx.x= ±0.5mm
xx.xx= ±0.25mm

Recommended Footprint Details

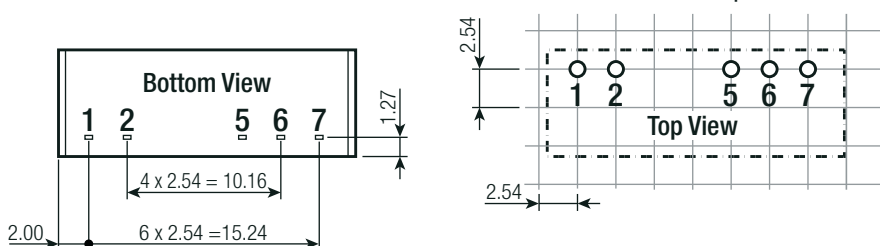

Specifications (measured @ Ta= 25°C, nom. Vin and full load unless otherwise stated)

INSTALLATION AND APPLICATION

IGBT Application Circuit

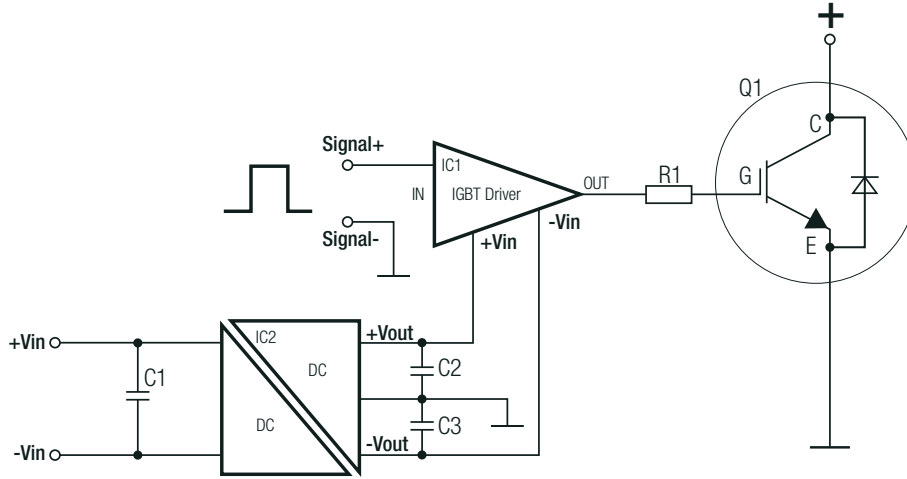

PACKAGING INFORMATION

Parameter	Type	Value
Packaging Dimension (LxWxH)	tube	520.0 x 16.0 x 9.0mm
Packaging Quantity		25pcs
Storage Temperature Range		-55°C to + 125°C
Storage Humidity	non-condensing	95% RH max.

The product information and specifications may be subject to changes even without prior written notice. The product has been designed for various applications; its suitability lies in the responsibility of each customer. The products are not authorized for use in safety-critical applications without RECOM's explicit written consent. A safety-critical application is an application where a failure may reasonably be expected to endanger or cause loss of life, inflict bodily harm or damage property. The applicant shall indemnify and hold harmless RECOM, its affiliated companies and its representatives against any damage claims in connection with the unauthorized use of RECOM products in such safety-critical applications.