

## Data Sheet | Item Number: 250-712

Double-deck PCB terminal block; push-button; 1.5 mm<sup>2</sup>; Pin spacing 5 mm; 24-pole;  
Push-in CAGE CLAMP®; agate gray

<https://www.wago.com/250-712>



Color: ■ agate gray

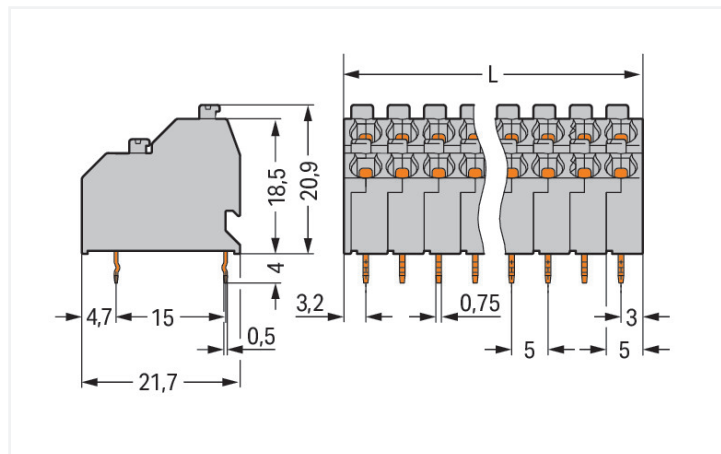

Dimensions in mm  
L = ((Polzahl / 2) x Rastermaß) + 1,2 mm

### PCB terminal block, 250 Series, Push-in CAGE CLAMP®

This PCB terminal block (item number 250-712) is designed for simple and secure connections. It is a universal connector that can be used practically anywhere, e.g., as a pluggable PCB connector, panel feedthrough header, connector for rail-mount terminal blocks, or a floating connector for different mounting methods. Strip lengths must be between 9 and 10 mm when connecting conductors to this PCB terminal block. This product features one conductor terminal and utilizes Push-in CAGE CLAMP®. Push-in CAGE CLAMP® connection technology is ideal for connecting all conductor types. Both solid and fine-stranded conductors with ferrules can be inserted without needing to use any tools—all thanks to its pluggable design. The item's dimensions are (61.2 x 24.9 x 21.7) mm (width x height x depth). Depending on the type of conductor, this PCB terminal block is designed for conductor cross sections ranging from 0.5 mm<sup>2</sup> to 1.5 mm<sup>2</sup>.

Tin is used for coating the contact surfaces. A push-button is used to operate this PCB terminal block. The PCB terminal block is designed for THT soldering. The conductor is designed to be inserted at a 45° angle..

### Notes

Variants:

Other pole numbers  
Other colors  
Direct marking  
Other versions (or variants) can be requested from WAGO Sales or configured at <https://configurator.wago.com/>.

### Electrical data

Ratings per	IEC/EN 60664-1		
Overtoltage category	III	III	II
Pollution degree	3	2	2
Nominal voltage	320 V	320 V	630 V
Rated impulse withstand voltage	4 kV	4 kV	4 kV
Rated current	10 A	10 A	10 A

Approvals per	UL 1059		
Use group	B	C	D
Rated voltage	300 V	-	300 V
Rated current	10 A	-	10 A

Approvals per	CSA		
	B	C	D
Use group	B	C	D
Rated voltage	300 V	-	300 V
Rated current	10 A	-	10 A

### Connection data

Clamping units	24
Total number of potentials	24
Number of connection types	1
Number of levels	2

### Connection 1

Connection technology	Push-in CAGE CLAMP®
Actuation type	Push-button
Solid conductor	0.5 ... 1.5 mm <sup>2</sup> / 20 ... 16 AWG
Fine-stranded conductor	0.75 ... 1.5 mm <sup>2</sup>
Fine-stranded conductor; with insulated ferrule	0.5 ... 1 mm <sup>2</sup>
Fine-stranded conductor; with uninsulated ferrule	0.5 ... 1 mm <sup>2</sup>
Note (conductor cross-section)	Fine-stranded conductor 0.75 ... 1.5 mm <sup>2</sup> (I max. 4 A) Fine-stranded conductor 0.5 mm <sup>2</sup> (I max. 2 A)
Strip length	9 ... 10 mm / 0.35 ... 0.39 inches
Conductor connection direction to PCB	45 °
Pole number	24

### Physical data

Pin spacing	5 mm / 0.197 inches
Width	61.2 mm / 2.409 inches
Height	24.9 mm / 0.98 inches
Height from the surface	20.9 mm / 0.823 inches
Depth	21.7 mm / 0.854 inches
Solder pin length	4 mm
Solder pin dimensions	0.5 x 0.75 mm
Drilled hole diameter with tolerance	1.2 <sup>(-0.1 ... +0.1)</sup> mm

### PCB contact

PCB contact	THT
Solder pin arrangement	over the entire terminal strip (in-line)
Number of solder pins per potential	1

### Material data

Note (material data)	<a href="#">Information on material specifications can be found here</a>
Color	agate gray
Material group	I
Insulation material (main housing)	Polyamide (PA66)
Flammability class per UL94	V0
Clamping spring material	Chrome-nickel spring steel (CrNi)
Contact material	Electrolytic copper (E <sub>Cu</sub> )
Contact Plating	Tin
Fire load	0.899 MJ
Weight	23 g

Environmental requirements	
Limit temperature range	-60 ... +105 °C

Commercial data	
Product Group	4 (Printed Circuit Connectors)
PU (SPU)	48 (12) pcs
Packaging type	Box
Country of origin	CH
GTIN	4044918304559
Customs tariff number	85369010000

Product Classification	
UNSPSC	39121409
eCl@ss 10.0	27-44-04-01
eCl@ss 9.0	27-44-04-01
ETIM 9.0	EC002643
ETIM 10.0	EC002643
ECCN	NO US CLASSIFICATION

Environmental Product Compliance	
RoHS Compliance Status	Compliant, No Exemption

### Approvals / Certificates

#### Declarations of conformity and manufacturer's declarations

Approval	Standard	Certificate Name
EU-Declaration of Conformity WAGO GmbH & Co. KG	-	-
UK-Declaration of Conformity WAGO GmbH & Co. KG	-	-

### Downloads

#### Environmental Product Compliance

Compliance Search	
Environmental Product Compliance 250-712	

## Documentation

### Additional Information

Technical Section	03.04.2019	pdf 2027.26 KB	<a href="#">↓</a>
-------------------	------------	-------------------	-------------------

## CAD/CAE-Data

<b>CAD data</b>	<b>CAE data</b>
2D/3D Models 250-712 <a href="#">↓</a>	EPLAN Data Portal 250-712 <a href="#">↓</a>
	ZUKEN Portal 250-712 <a href="#">↓</a>

## PCB Design









Symbol and Footprint via SamacSys 250-712 <a href="#">↓</a>
Symbol and Footprint via Ultra Librarian 250-712 <a href="#">↓</a>

## 1 Compatible Products

### 1.1 Optional Accessories





#### 1.1.1 Ferrule

##### 1.1.1.1 Ferrule

 <b>Item No.: 216-241</b> Ferrule; Sleeve for 0.5 mm <sup>2</sup> / 20 AWG; insulated; electro-tin plated; electrolytic copper; gastight crimped; acc. to DIN 46228, Part 4/09.90; white	 <b>Item No.: 216-141</b> Ferrule; Sleeve for 0.5 mm <sup>2</sup> / 20 AWG; un-insulated; electro-tin plated; electrolytic copper; gastight crimped; acc. to DIN 46228, Part 1/08.92	 <b>Item No.: 216-242</b> Ferrule; Sleeve for 0.75 mm <sup>2</sup> / 18 AWG; insulated; electro-tin plated; electrolytic copper; gastight crimped; acc. to DIN 46228, Part 4/09.90; gray	 <b>Item No.: 216-262</b> Ferrule; Sleeve for 0.75 mm <sup>2</sup> / 18 AWG; insulated; electro-tin plated; electrolytic copper; gastight crimped; acc. to DIN 46228, Part 4/09.90; gray
 <b>Item No.: 216-142</b> Ferrule; Sleeve for 0.75 mm <sup>2</sup> / 18 AWG; un-insulated; electro-tin plated; electrolytic copper; gastight crimped; acc. to DIN 46228, Part 1/08.92	 <b>Item No.: 216-243</b> Ferrule; Sleeve for 1 mm <sup>2</sup> / AWG 18; insulated; electro-tin plated; electrolytic copper; gastight crimped; acc. to DIN 46228, Part 4/09.90; red	 <b>Item No.: 216-263</b> Ferrule; Sleeve for 1 mm <sup>2</sup> / AWG 18; insulated; electro-tin plated; electrolytic copper; gastight crimped; acc. to DIN 46228, Part 4/09.90; red	 <b>Item No.: 216-143</b> Ferrule; Sleeve for 1 mm <sup>2</sup> / AWG 18; un-insulated; electro-tin plated; electrolytic copper; gastight crimped; acc. to DIN 46228, Part 1/08.92

#### 1.1.2 Marking

##### 1.1.2.1 Marking strip

 <b>Item No.: 210-332/500-202</b> Marking strips; as a DIN A4 sheet; MARKED; 1-16 (160x); Height of marker strip: 3 mm; Strip length 182 mm; Horizontal marking; Self-adhesive; white	 <b>Item No.: 210-332/500-205</b> Marking strips; as a DIN A4 sheet; MARKED; 1-32 (80x); Height of marker strip: 3 mm; Strip length 182 mm; Horizontal marking; Self-adhesive; white	 <b>Item No.: 210-332/500-204</b> Marking strips; as a DIN A4 sheet; MARKED; 17-32 (160x); Height of marker strip: 3 mm; Strip length 182 mm; Horizontal marking; Self-adhesive; white	 <b>Item No.: 210-332/500-206</b> Marking strips; as a DIN A4 sheet; MARKED; 33-48 (160x); Height of marker strip: 3 mm; Strip length 182 mm; Horizontal marking; Self-adhesive; white
--	---	--	---

### 1.1.3 Test and measurement

#### 1.1.3.1 Testing accessories



**Item No.: 210-136**

Test plug; 2 mm Ø; with 500 mm cable; red

### 1.1.4 Tool

#### 1.1.4.1 Operating tool



**Item No.: 210-719**

Operating tool; Blade: 2.5 x 0.4 mm; with a partially insulated shaft



**Item No.: 210-647**

Operating tool; Blade: 2.5 x 0.4 mm; with a partially insulated shaft; multicoloured

## Installation Notes

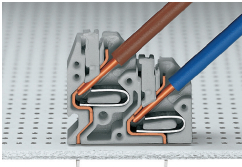

Space-saving wiring – push-in termination of solid conductors.

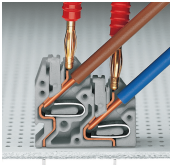

Testing with 2 mm Ø test plug – touch contact.

## Conductor termination

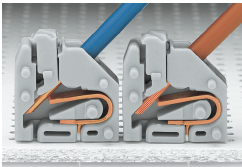

Inserting solid conductors via push-in termination.  
Inserting fine-stranded conductors via push-buttons, 250 Series – 3.5 mm pin spacing.

## Conductor termination



Space-saving wiring, 250 Series – 5 mm pin spacing.

## Testing



Testing with 11 mm Ø test pin, on the conductor, 250 Series – 2.5 ... 3.5 mm pin spacing.



Testing with 2 mm Ø test plug, touch contact, 250 Series – 5 mm pin spacing.

## Marking



Labeling via self-adhesive strips or direct marking. Mixed-color terminal strips (with or without spacer) are available upon request.



Labeling via self-adhesive strips or direct marking. Mixed-color terminal strips (with or without spacer) are available upon request.