

638551-1 ✓ ACTIVE

AMP | AMP 0.64 Connector System

TE Internal #: 638551-1

Receptacle Terminal, 20 – 18 AWG, .5 – .8 mm<sup>2</sup> Wire, .8 mm [.031 in] Tab Width, Tin (Sn), .64 mm [.025 in] Tab Thickness, AMP 0.64 Connector System

[View on TE.com >](#)



Automotive Parts > Automotive Terminals



Terminal Type: **Receptacle**

Wire Size: **20 – 18 AWG**

Mating Tab Width: **.8 mm [.031 in]**

Interface Plating: **Tin (Sn)**

### Features

#### Product Type Features

Receptacle Style	180°
Primary Locking Feature	On the Terminal
Sealable	No

#### Body Features

Terminal Seal Type	Unsealed
--------------------	----------

#### Contact Features

Typical Current Rating	7.7 A
Crimp Type	F-Crimp
Contact Size	.64mm
Contact Fabrication	Stamped & Formed
Wire Contact Termination Area Plating Material	Tin
Terminal Type	Receptacle
Mating Tab Width	.8 mm [.031 in]
Interface Plating	Tin (Sn)
Mating Tab Thickness	.64 mm [.025 in]

#### Termination Features

Termination Method to Wire & Cable	Crimp
Product Terminates To	Wire

#### Dimensions



Compatible Insulation Diameter Range	.5 – .75 mm [.055 – .083 in]
Wire Size	20 – 18 AWG
Wire Size Search	.5 mm <sup>2</sup> , .6 mm <sup>2</sup> , .8 mm <sup>2</sup>
Tab Length	17.25 mm [.68 in]

### Usage Conditions

Insulation Option	Uninsulated
Operating Temperature (Max)	125 °C [212 °F]
Operating Temperature Range	-40 – 125 °C [-40 – 257 °F]

### Operation/Application

Compatible With Wire Base Material	Copper
------------------------------------	--------

### Packaging Features

Packaging Method	Package
Packaging Quantity	7000

### Other

Terminal Transmits	0 – 24 A (Low Power)
--------------------	----------------------

## Product Compliance

[For compliance documentation, visit the product page on TE.com>](#)

EU RoHS Directive 2011/65/EU	Compliant
EU ELV Directive 2000/53/EC	Compliant
China RoHS 2 Directive MIIT Order No 32, 2016	有害物质含量符合标准要求 No Restricted Substance(s) Above Threshold
EU REACH Regulation (EC) No. 1907/2006	Current ECHA Candidate List: JUNE 2025 (250) Candidate List Declared Against: JUNE 2025 (250) Does not contain REACH SVHC
Halogen Content	Low Halogen - Br, Cl, F < 900 ppm per homogenous material. Also BFR/CFR/PVC Free
Solder Process Capability	Not applicable for solder process capability

#### Product Compliance Disclaimer

This information is provided based on reasonable inquiry of our suppliers and represents our current actual knowledge based on the information they provided. This information is subject to change. The part numbers that TE has identified as EU RoHS compliant have a maximum concentration of 0.1% by weight in homogenous materials for lead, hexavalent chromium, mercury, PBB, PBDE, DBP, BBP, DEHP, DIBP, and 0.01% for cadmium, or qualify for an exemption to these

limits as defined in the Annexes of Directive 2011/65/EU (RoHS2). Finished electrical and electronic equipment products will be CE marked as required by Directive 2011/65/EU. Components may not be CE marked. Additionally, the part numbers that TE has identified as EU ELV compliant have a maximum concentration of 0.1% by weight in homogenous materials for lead, hexavalent chromium, and mercury, and 0.01% for cadmium, or qualify for an exemption to these limits as defined in the Annexes of Directive 2000/53/EC (ELV). Regarding the REACH Regulation, the information TE provides on SVHC in articles for this part number is based on the latest European Chemicals Agency (ECHA) 'Guidance on requirements for substances in articles' posted at this URL: <https://echa.europa.eu/guidance-documents/guidance-on-reach>

## Compatible Parts



TE Part # 1-1326327-1  
46P PLUG ASSY, EBC440, RIGHT H,  
1 SLOT, NO2.8



TE Part # 2-1488107-1  
OPTION PLUG W/ CPA AND ONLY CI



TE Part # 2203937-5  
52 pos plug assy, 0.64 and 2.8

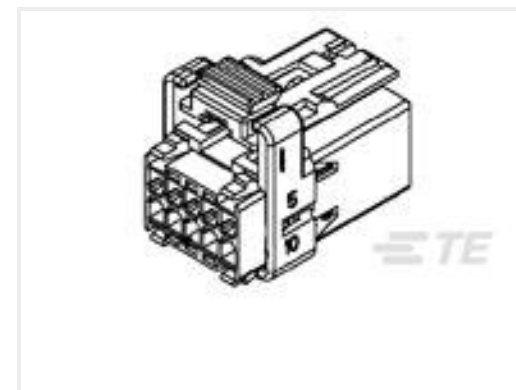

TE Part # 638397-1  
ASSY, 18P PLUG "A" KEY W/O CPA



TE Part # 1-1897168-2  
0.64MM SLD 6(10)P PLUG ASSY-A BLK



TE Part # 1438426-3  
0.64MM, 2 POSN SEALED PLUG, GRA



TE Part # 1326133-1  
RECEPTACLE HOUSING, 18 POSITIO

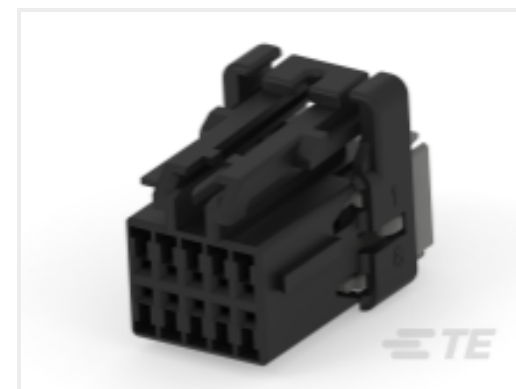

TE Part # 638393-1  
10P PLUG ASSY A KEY W/O CPA



TE Part # 638394-4  
ASSY, 12P PLUG "D" KEY, W/O CPA



TE Part # 2-1897168-2  
0.64MM SLD 4(10)P PLUG ASSY-A BLK



TE Part # 776932-3  
52 pos plug, 0.64 and 2.80mm



TE Part # 7-2151580-7  
OCEAN\_2.0\_SPARE\_PART\_KIT-  
062F067F



TE Part # 1326141-1  
32WAY LAC RECEPTACLE CARRIER H



TE Part # 638392-1  
.64MM PLUG ASSY, KEY A, W/O CPA



TE Part # 2-1326327-8  
46P PLUG ASSY, EBC440, RIGHT H,  
1 SLOT, NO2.8



TE Part # 1-1897168-3  
0.64MM SLD 6(10)P PLUG ASSY-A GRY



Also in the Series | **AMP 0.64 Connector System**

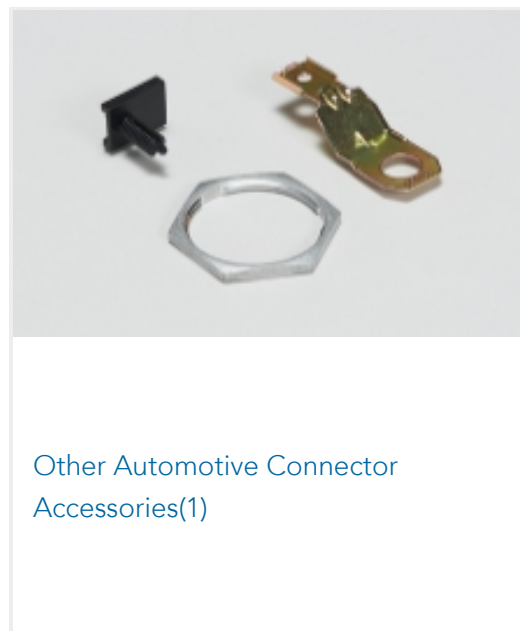
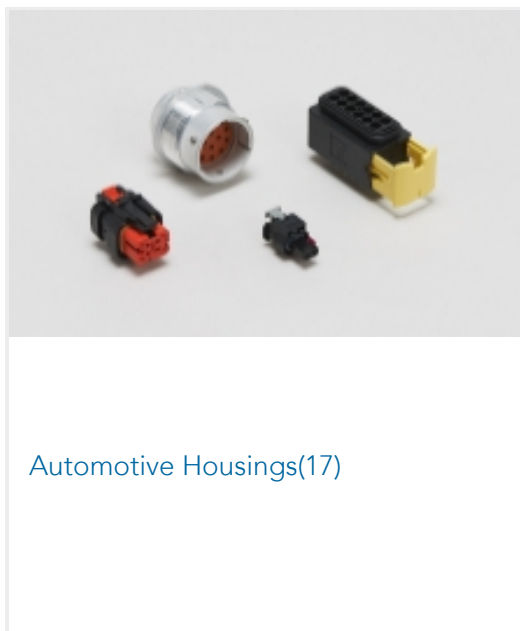

Customers Also Bought

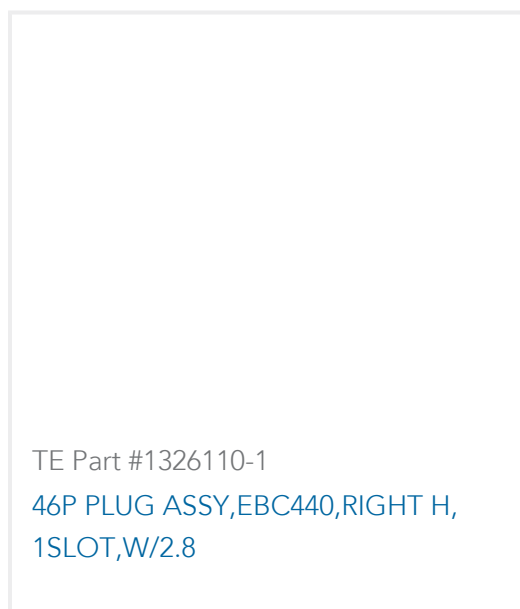
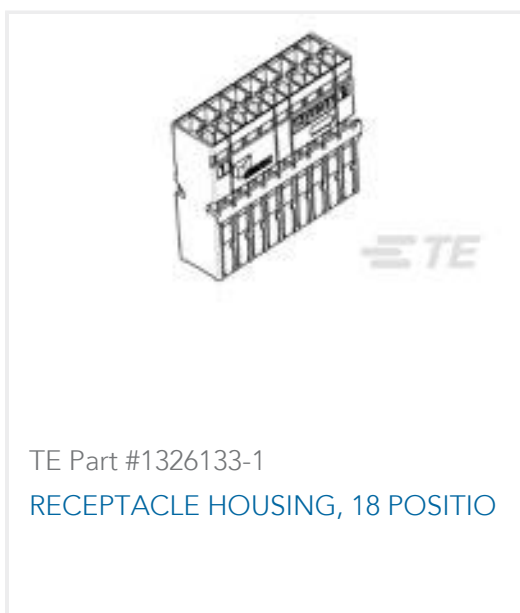
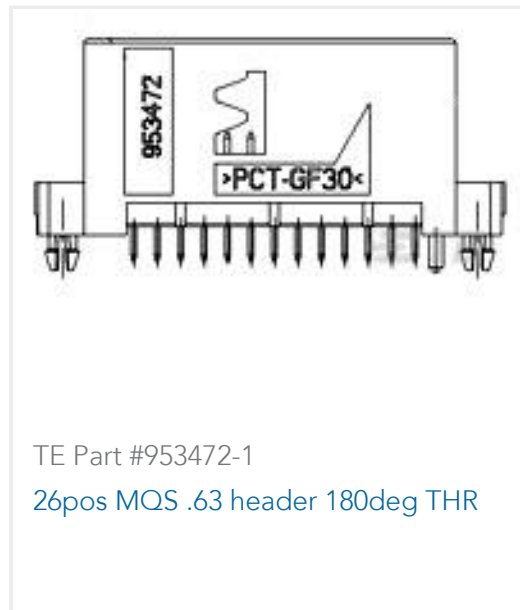



## Documents

### Product Drawings

[CONTACT,FEMALE,0.64MM,SN,18-20](#)

English

---

### CAD Files

Customer View Model

[ENG\\_CVM\\_638551-1\\_B.3d\\_igs.zip](#)

English

Customer View Model

[ENG\\_CVM\\_638551-1\\_B.3d\\_stp.zip](#)

English

Customer View Model

[ENG\\_CVM\\_638551-1\\_B.2d\\_dxf.zip](#)

English

[3D PDF](#)

English

By downloading the CAD file I accept and agree to the [Terms and Conditions](#) of use.

---

### Product Specifications

[Application Specification](#)

English

---

### Instruction Sheets

[Instruction Sheet \(U.S.\)](#)

English

[Instruction Sheet \(U.S.\)](#)

English