

IEC Appliance Inlet C14 with Fuseholder 1- or 2-pole, Line Switch 2-pole and Voltage Selector



Order required accessories separately

IEC connector C14 with fuse holder 1- or 2-pole
 Line switch 2-pole
 Snap-in mounting from front side



See below:
[Approvals and Compliances](#)

Description

- Panel mount :
 Screw-on version from front or rear side, snap-in version front side
- 4 Functions :
 Appliance Inlet Protection class I , Line Switch 2-pole , Fuseholder with interchangeable fuse drawer for Fuse-links 5x20 mm or 6.3x32 mm , with or without voltage selector (step)
- V-Lock notch standard
- Meets the requirements of IEC 60335-1 for appliances in unattended use. This includes the enhanced requirements of glow wire tests acc. to IEC 60695-2-12 and -13.
- Quick connect terminals 4.8 x 0.8 mm

Characteristics

- All single elements are already wired
- The fuse drawer "Fingergrip" can be removed by hand
- Suitable for use in equipment according to IEC/UL 62368-1

Other versions on request

- Line switch, illuminated
- Line switch with other rocker marking
- Line switch 1-pole
- For protection class II (without CCC approval)

References

Alternative: version with line filter [CD](#)

Weblinks

[pdf data sheet](#), [html datasheet](#), [General Product Information](#), [Approvals](#), [Distributor-Stock-Check](#), [Accessories](#), [Detailed request for product](#)

Technical Data

Ratings IEC	10A / 250VAC; 50Hz	Appliance inlet/-outlet	C14 acc. to IEC 60320-1, UL 60320-1, CSA C22.2 no. 60320-1 (for cold conditions) pin-temperature 70 °C, 10A, Protection Class I
Ratings UL/CSA	10A / 250VAC; 60Hz	Fuseholder	1-/2-pole, Shocksafe category PC2 acc. to IEC 60127-6, for fuse-links 5 x 20 / 6.3 x 32 mm
Dielectric Strength	> 3 kVAC between L-N > 4 kVAC between L/N-PE (1 min/50Hz)	Rated Power Acceptance @ Ta 23 °C	5 x 20: 2.5W (1 pole)/ 2W (2-pole) per pole 6.3 x 32: 3.15W (1 pole)/ 2.5W (2-pole) per pole
Allowable Operation Temperature	-25 °C to 70 °C	Power Acceptance @ Ta > 23 °C	Admissible power acceptance at higher ambient temperature see derating curves
IP-Protection	front side IP40 acc. to IEC 60529	Line Switch	Rocker switch 2-pole, non-illuminated, acc. to IEC 61058-1 Technical Details
Protection against electric shock	Suitable for appliances with protection class I acc. to IEC 61140	Voltage Selector	optional, step, 2-4 digits
Terminal	Quick connect terminals 4.8 x 0.8 mm , tin-plated		
Panel Thickness S	Screw: max 8 mm Mounting screw torque max 0.5Nm Snap-in: 1.5/2/2.5 mm		
Material: Housing	Thermoplastic, black, UL 94V-0		

Approvals and Compliances



Detailed information on product approvals, code requirements, usage instructions and detailed test conditions can be looked up in [Details about Approvals](#)

SCHURTER products are designed for use in industrial environments. They have approvals from independent testing bodies according to national and international standards. Products with specific characteristics and requirements such as required in the automotive sector according to IATF 16949, medical technology according to ISO 13485 or in the aerospace industry can be offered exclusively with customer-specific, individual agreements by SCHURTER.

Approvals





The approval mark is used by the testing authorities to certify compliance with the safety requirements placed on electronic products.

Approval Reference Type: KD

Approval Logo	Certificates	Certification Body	Description
	VDE Approvals	VDE	Certificate Number: 40046766
	UL Approvals	UL	UR File Number: E93617
	CCC Approvals	CCC	CCC Certificate Number: 2010010204409773

Product standards

Product standards that are referenced

Organization	Design	Standard	Description
	Designed according to	IEC 60320-1	Appliance couplers for household and similar general purposes
	Designed according to	IEC 60127-6	Miniature fuses. Part 6. Fuse-holders for miniature fuse-links
	Designed according to	IEC 61058-1	Switches for appliances. Part 1. General requirements
	Designed according to	UL 60320-1	Standard for Attachment Plugs and Receptacles
	Designed according to	CSA C22.2 no. 60320-1	General Use Receptacles, Attachment Plugs, and Similar Wiring Devices









Application standards

Application standards where the product can be used

Organization	Design	Standard	Description
	Suitable for applications acc.	IEC/UL 62368-1	Audio/video, information and communication technology equipment - Part 1: Safety requirements
	Suitable for applications acc.	IEC 60601-1	Medical electrical equipment - Part 1: General requirements for basic safety and essential performance
	Suitable for applications acc.	IEC 60335-1	Safety of electrical appliances for household and similar purposes. Meets the requirements for appliances in unattended use. This includes the enhanced requirements of glow wire tests acc. to IEC 60695-2-11 or -12 & -13.

Compliances

The product complies with following Guide Lines

Identification	Details	Initiator	Description
	CE declaration of conformity	SCHURTER AG	The CE marking declares that the product complies with the applicable requirements laid down in the harmonisation of Community legislation on its affixing in accordance with EU Regulation 765/2008.
	UKCA declaration of conformity	SCHURTER AG	The UKCA marking declares that the product complies with the applicable requirements laid down in the British Amendment of Regulation (EC) 765/2008.
	RoHS	SCHURTER AG	Directive RoHS 2011/65/EU, Amendment (EU) 2015/863
	China RoHS	SCHURTER AG	The law SJ / T 11363-2006 (China RoHS) has been in force since 1 March 2007. It is similar to the EU directive RoHS.
	REACH	SCHURTER AG	On 1 June 2007, Regulation (EC) No 1907/2006 on the Registration, Evaluation, Authorization and Restriction of Chemicals 1 (abbreviated as "REACH") entered into force.
		SCHURTER AG	V-Lock system are based on a matching plug-dose combination. The connector is equipped with a notch intended for use with the latching cordset. The cord latching system prevents against accidental removal of the cordset.
	White Paper Glow wire test	SCHURTER AG	Meets the requirements of IEC 60335-1 for appliances in unattended use. This includes the enhanced requirements of glow wire tests acc. to IEC 60695-2-11 or -12 &-13.
	Medical Equipment	SCHURTER AG	Suitable for use in medical equipment according to IEC/UL 60601-1 (1 MOOP, 1 MOPP)

Dimensions [mm]
 Screw-on mounting

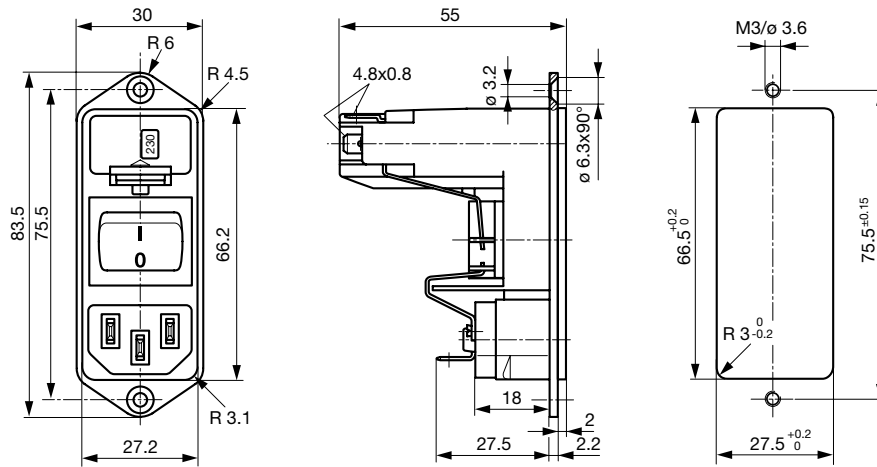

Snap-in mounting

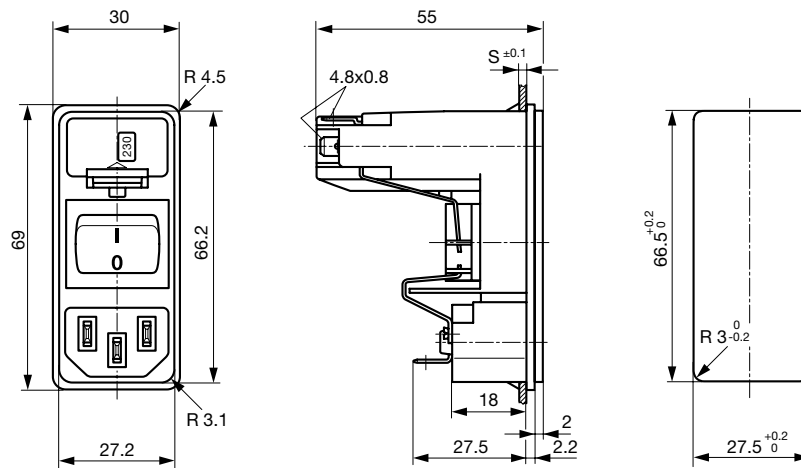

Diagrams

without voltage selector

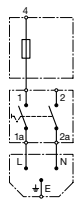

1-pole

without voltage selector



2-pole

with voltage selector

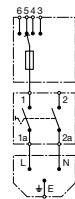

1-pole

with voltage selector

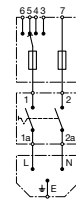

2-pole

Derating Curves

Fuses

5 x 20 mm (1-pole)



Fuses

5 x 20 mm (2-pole, per pole)



Fuses

6.3 x 32 mm (1-pole)

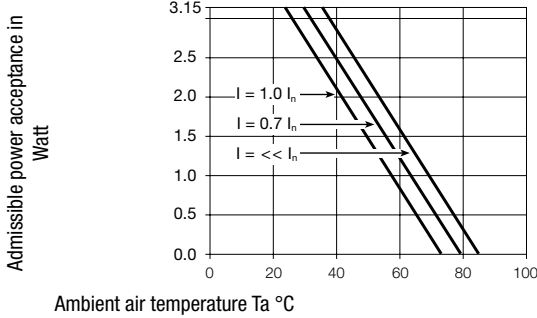

Fuses

6.3 x 32 mm (2-pole, per pole)

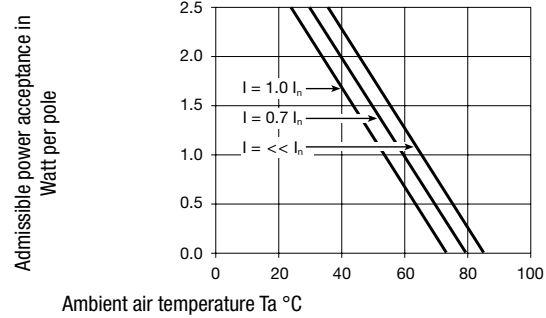

Variants

Type	Panel mounting	Panel Thickness s [mm]	Fuseholder	Line Switch	Voltage selector max. 4 pos*	Order Number
KD	Snap-in	1.5	1-pole	Rocker switch	-	KD13.1101.105
KD	Snap-in	2	1-pole	Rocker switch	-	KD13.1101.107
KD	Snap-in	2.5	1-pole	Rocker switch	-	KD13.1101.109
KD	Snap-in	1.5	1-pole	Rocker switch	2-4 digits	KD13.4101.105
KD	Snap-in	2	1-pole	Rocker switch	2-4 digits	KD13.4101.107
KD	Snap-in	2.5	1-pole	Rocker switch	2-4 digits	KD13.4101.109
KD	Snap-in	1.5	2-pole	Rocker switch	-	KD14.1101.105
KD	Snap-in	2	2-pole	Rocker switch	-	KD14.1101.107
KD	Snap-in	2.5	2-pole	Rocker switch	-	KD14.1101.109
KD	Snap-in	1.5	2-pole	Rocker switch	2-4 digits	KD14.4101.105
KD	Snap-in	2	2-pole	Rocker switch	2-4 digits	KD14.4101.107
KD	Snap-in	2.5	2-pole	Rocker switch	2-4 digits	KD14.4101.109
KD	Screw	-	1-pole	Rocker switch	-	KD13.1101.151
KD	Screw	-	1-pole	Rocker switch	2-4 digits	KD13.4101.151
KD	Screw	-	2-pole	Rocker switch	-	KD14.1101.151
KD	Screw	-	2-pole	Rocker switch	2-4 digits	KD14.4101.151

Availability for all products can be searched real-time: <https://www.schurter.com/en/info-center/support-tools/stock-check-distributors>

Can be used as 2-/3-position voltage selector - take only corresponding terminals.

The fuse drawer is not included and must be ordered separately (see required accessory).

Packaging unit

20 Pcs



Required Accessory

Description	
	Fusedrawer_3 Fusedrawer for Fuse Links 5x20 mm resp. 6.3x32 mm
	Fingergrip, 5 x 20, 2-pole, Voltage Selector 4303.2014.00
	Fingergrip, 5 x 20, 2-pole, Voltage Selector, 100, 120, 220, 240 4303.2014.01
	Fingergrip, 5 x 20, 2-pole, Voltage Selector, 110, 150, 220 4303.2014.02
	Fingergrip, 5 x 20, 2-pole, Voltage Selector, 110, 220 4303.2014.03
...	

Accessories

	Wire_Harness Wire harness for SCHURTER products
	RC320 Rear Cover for Power Entry Module
	Cord_retaining_kits Cord retaining strain relief
	Flat head, A 4700.0001

Mating Outlets/Connectors

Category / Description	
	Appliance Outlet Overview complete
	4787, Mounting: Screw-on mounting, Appliance Outlet: IEC Solder terminals, 10 A, Suitable for appliances with protection class I 4787
	4788, Mounting: Snap-in version, Appliance Outlet: IEC Solder / Quick Connect, 10 A, Suitable for appliances with protection class I 4788
IEC Appliance Outlet F or H, Screw-on Mounting, Front Side, Solder, PCB or Quick-connect Terminal 5091	
	Connector Overview complete
	4782 Mounting: Power Cord, 3 x 1 mm ² / 3 x 18 AWG, Cable, Connector: IEC C13 4782
	4785 Mounting: Power Cord, 3 x 1 mm ² / 3 x 18 AWG, Cable, Connector: IEC C13 4785
	4300-06 Mounting: Power Cord, 3 x 1 mm ² / 3 x 18 AWG, Cable, Connector: IEC C13 4300-06
	4781 Mounting: Power Cord, Cable, Connector: IEC C15 4781
4784 Mounting: Power Cord, 3 x 1 mm ² / 3 x 18 AWG, Cable, Connector: IEC C15 4784	

Mating Outlets/Connectors shuttered



[Connector Overview complete](#)

4783 Mounting: Power Cord, 3 x 1 mm² / 3 x 18 AWG, Cable, Connector: IEC C13

4783



[Power Cord Overview complete](#)

VAC13KS, Overview, V-Lock cord retaining, diverse Connector IEC C13, diverse, black

VAC13KS