



FASTIN-FASTON | FASTIN-FASTON 110

TE Internal #: 160655-2

Quick Disconnect Receptacle, Uninsulated, 20 – 15 AWG, .51 – 1.65 mm² Wire, 2.8 mm [.11 in] Tab Width, F-Crimp, Straight, FASTIN-FASTON 110

[View on TE.com >](#)

Terminals & Splices > Quick Disconnects

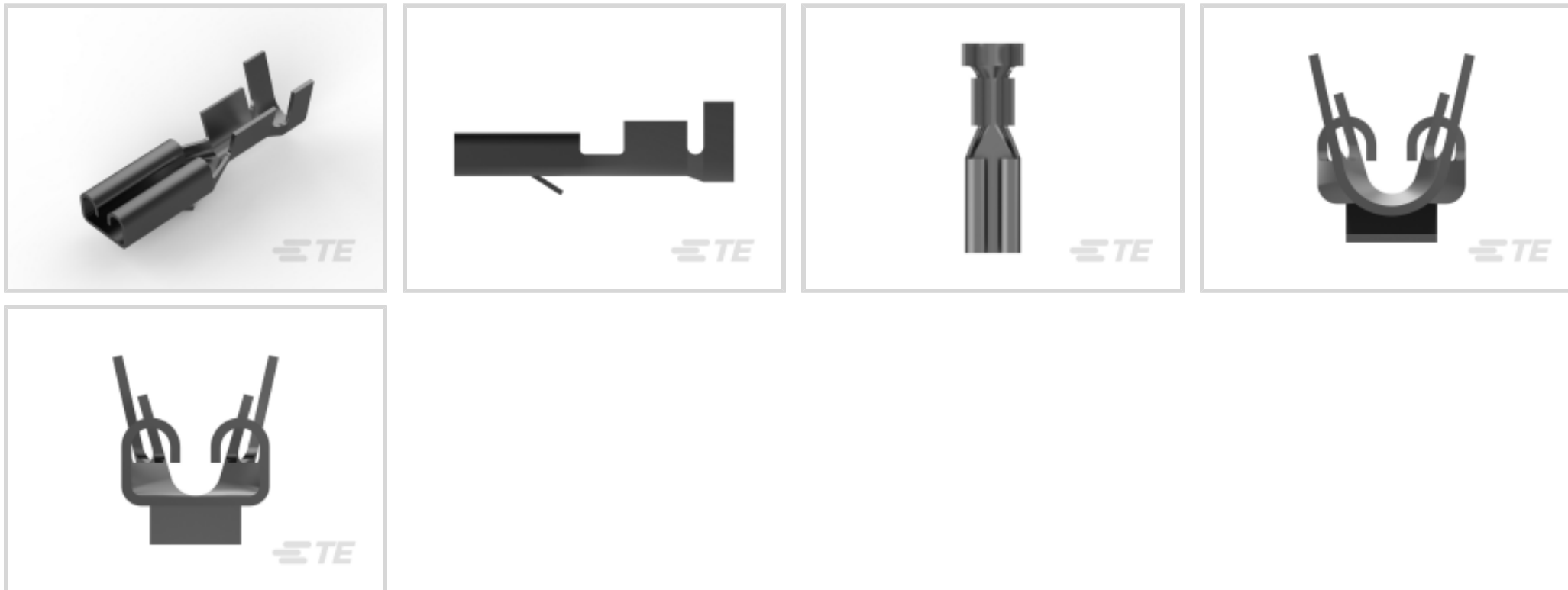

Quick Disconnect Terminal Type: **Receptacle**

Wire Size: **.51 – 1.65 mm²**

Mating Tab Width: **2.8 mm [.11 in]**

Mating Tab Thickness: **.81 mm [.032 in]**

Features

Product Type Features

Insertion Force	Normal
-----------------	--------

Configuration Features

Compatible With Wire & Cable Type	Discrete Wire
Connection Capacity	Single

Contact Features

Quick Disconnect Terminal Type	Receptacle
Mating Tab Width	2.8 mm [.11 in]
Mating Tab Thickness	.81 mm [.032 in]
Terminal Orientation	Straight
Contact Base Material	Phosphor Bronze
Terminal Plating Material	Pre-Tin
Crimp Type	F-Crimp
Barrel Type	Open

Termination Features

--	--



Product Terminates To	Wire & Cable
-----------------------	--------------

Mechanical Attachment

	.038 in
Wire Insulation Support	With
Mating Retention Type	Dimple

Dimensions

Product Length	14 mm [.551 in]
Compatible Insulation Diameter Range	2.01 – 3.1 mm [.079 – .122 in]
Terminal Material Thickness	.25 mm [.01 in]
Wire Size	.51 – 1.65 mm ²

Usage Conditions

Insulation Option	Uninsulated
Operating Temperature Range	-40 – 110 °C [-40 – 230 °F]

Packaging Features

Packaging Quantity	1000
Packaging Method	Strip/Reel

Product Compliance

[For compliance documentation, visit the product page on TE.com>](#)

EU RoHS Directive 2011/65/EU	Compliant
EU ELV Directive 2000/53/EC	Compliant
China RoHS 2 Directive MIIT Order No 32, 2016	有害物质含量符合标准要求 No Restricted Substance(s) Above Threshold
EU REACH Regulation (EC) No. 1907/2006	Current ECHA Candidate List: JUNE 2025 (250) Candidate List Declared Against: JUNE 2025 (250) Does not contain REACH SVHC
Halogen Content	Low Halogen - Br, Cl, F < 900 ppm per homogenous material. Also BFR/CFR/PVC Free
Solder Process Capability	Not applicable for solder process capability

Product Compliance Disclaimer

This information is provided based on reasonable inquiry of our suppliers and represents our current actual knowledge based on the information they provided. This information is subject to change. The part numbers that TE has identified as EU RoHS compliant have a maximum concentration of 0.1% by weight in homogenous materials for lead, hexavalent

chromium, mercury, PBB, PBDE, DBP, BBP, DEHP, DIBP, and 0.01% for cadmium, or qualify for an exemption to these limits as defined in the Annexes of Directive 2011/65/EU (RoHS2). Finished electrical and electronic equipment products will be CE marked as required by Directive 2011/65/EU. Components may not be CE marked. Additionally, the part numbers that TE has identified as EU ELV compliant have a maximum concentration of 0.1% by weight in homogenous materials for lead, hexavalent chromium, and mercury, and 0.01% for cadmium, or qualify for an exemption to these limits as defined in the Annexes of Directive 2000/53/EC (ELV). Regarding the REACH Regulation, the information TE provides on SVHC in articles for this part number is based on the latest European Chemicals Agency (ECHA) 'Guidance on requirements for substances in articles' posted at this URL: <https://echa.europa.eu/guidance-documents/guidance-on-reach>

Compatible Parts



TE Part # 2150017-2
OCEAN_2.0_Applicator-E-070F130F-REA



TE Part # 2150017-1
OCEAN_2.0_Applicator-E-070F130F-REM



TE Part # 925015-1
FF 110 REC HSG 3P NYLON BLACK



TE Part # 7-2150017-7
OCEAN_2.0_SPARE_PART_KIT-070F130F

Also in the Series | FASTIN-FASTON 110



Automotive Housings(6)



Automotive Signal & Power Connector Housings(6)



Automotive Terminals(5)

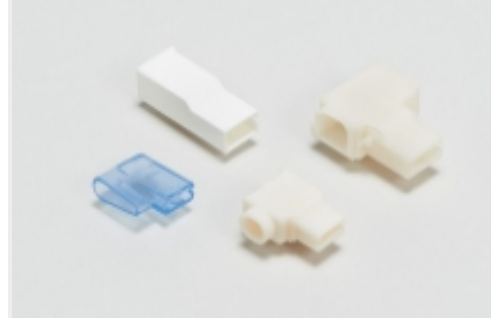

Crimp Terminal Housings(33)



Insertion & Extraction Tools(3)



Quick Disconnects(75)

Customers Also Bought

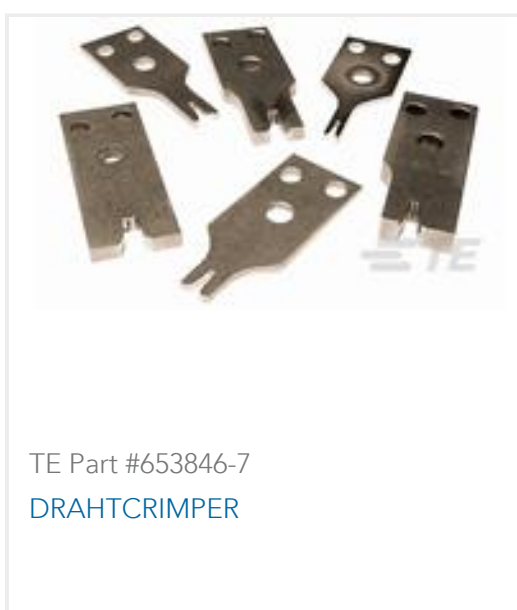
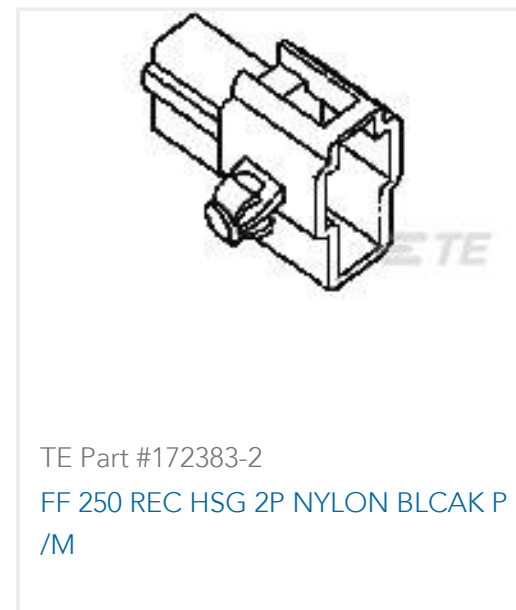

Documents

Product Drawings

[FASTON 110 REC 20-15 AWG PTPB](#)

English

CAD Files

[3D PDF](#)

3D

Customer View Model

[ENG_CVM_CVM_160655-2_AJ.2d_dxf.zip](#)

English

Customer View Model

[ENG_CVM_CVM_160655-2_AJ.3d_igs.zip](#)

English

Customer View Model

[ENG_CVM_CVM_160655-2_AJ.3d_stp.zip](#)

English

By downloading the CAD file I accept and agree to the [Terms and Conditions](#) of use.

Datasheets & Catalog Pages



[FASTIN_FASTON_Product_Line](#)

English

[Product Specifications](#)

[EB**General Application Specification for Open Barrel Terminals](#)

English

[Application Specification](#)

English

[Agency Approvals](#)

[UL Report](#)

English