

# Dura-Con™

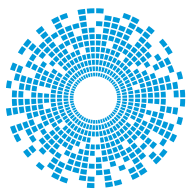

## Product Catalog



**cinch**  
CONNECTIVITY SOLUTIONS  
a bel group

[belfuse.com/cinch](http://belfuse.com/cinch)

# About Bel

---

Bel is a publicly traded company that has been operated by the same family for over 65 years. Our history of organic growth and acquisitions have broadened our product portfolio. This has established Bel as a world leader with a diverse offering of power, protection and interconnect products. We design and manufacture these products which are primarily used in the networking, telecommunications, computing, military, aerospace, transportation and broadcasting industries. Bel's portfolio of products also finds application in the automotive, medical and consumer electronics markets.

# About Dura-Con™

---

Cinch Dura-Con™ connectors are designed for applications that require a rugged, durable, and high-performance interconnect. Dura-Con is the ideal connector for applications where weight and space must be kept to a minimum while maintaining maximum reliability. Miniaturized airborne electronics and data processing equipment, where shorter signal paths are needed, represent typical applications for these unique connectors.

# Table of Contents

---

## Introduction

Introduction	1
--------------	---

## Dura-Con™ Micro-D Connectors

Metal Shell Micro-D Connectors	2
Plastic Shell Micro-D Connectors	4
Metal Shell Micro-D Connectors for PCBs	6
Hermetically Sealed Micro-D Connectors	10
Hermetic Hardware	12
High Temperature Metal Shell Micro-D Connectors	13
High Temperature Metal Shell Micro-D for PCBs	15
Micro-D Jumper Assemblies	16
Combi	17
Shielded Cable Assemblies	18
Connector Savers	19
Micro-D Dust Covers	20
Micro-D Sealing Gaskets	21
Mounting Hardware	22
Micro-D EMI Backshells	24
Micro-D Strain Relief Backshells	25

## Dura-Con™ MIL-DTL-83513 Connectors

MIL-DTL-83513 Metal Shell Connectors	26
MIL-DTL-83513 Plastic Shell Connectors	27
MIL-DTL-83513 Metal Shell Connectors for PCBs	30
Mounting Hardware	31

## Dura-Con™ Strip Connectors

Strip Connectors	36
------------------	----

## Appendix

Appendix A Material Specifications	37
Appendix B Performance Specifications	38
Appendix C Contact Arrangements	39
Appendix D Panel Cutouts	42
Appendix E Wire Information	44
Appendix F Material Compliance	46
Appendix G Military to Commercial Part No. Cross Reference	47

The heart of the Dura-Con system is the Dura-Con twist pin contact. The Cinch Dura-Con twist pin contact is made from a precision miniature spring cable with a welded tip. The expanded cable provides seven spring members peripherally around the pin so that contact is maintained with the mating socket wall no matter what radial forces are applied. This spring may be flexed many times without any evidence of metal fatigue. Reliable mating is further ensured by protecting the pin contact in a tightly toleranced recessed cavity.

Cinch's family of Dura-Con connectors includes MIL-C-83513 Series connectors along with our own commercial equivalents. The commercial Dura-Con product line offers an expanded range of termination and hardware options for all-plastic and metal shell wire versions and right-angle and straight PC board mount "terminal blocks". Cinch also packages the Dura-Con contact in a very low profile plastic strip connector on .050" centers and in a line of high-density microminiature edge (Microedge) board connectors that meet the requirements of MIL-C-55302. Cinch has created a line of plastic and metal shell Dura-Con connector savers for very high mating cycle applications such as test equipment.

## Termination Options

Cinch offers the following termination methods for its Dura-Con connectors:

- **Insulated Wire** - #26 AWG Insulated wire is crimped to the Dura-Con contacts then epoxy backpotted at the factory. Wire is available in standard lengths of 18, 24, 36, and 48 inches.
- **Uninsulated Wire** - #25 AWG, gold-plated, uninsulated wire is crimped to the Dura-Con contact at the factory. Wire is available in standard lengths of 0.5, 1.0, and 2.0 inches. This option allows the user greater flexibility when installing the connector.
- **Solder Cup** - For applications that require the lowest contact resistance, Cinch offers Dura-Con connectors with solder cups for termination by the user.
- **PCB Tails** - Available for straight and right angle configurations, and includes additional insulator with raised floor for PCB mounting.

## Custom Capabilities

Standard Cinch Dura-Con connectors satisfy a wide variety of applications. Cinch's line of Dura-Con microminiature D-shaped connectors are one of the most versatile in the industry. There are thousands of possible combinations of Cinch standard options such as connector type, size, materials, hardware, and termination.

When special application requirements arise, Cinch Dura-Con connectors take this versatility to the next level. Whether specific needs entail new variations of simple end-to-end connector assemblies or more complex and intricate harness assemblies, Cinch Connector Division has the state-of-the-art engineering resources and research facilities in place to meet your needs. Cinch approaches your business with a well-defined goal: to ensure the integrity of your design and to execute our contribution to it in a responsible, cost-effective manner. This philosophy has led Cinch to a position of industry leadership.

For complete information regarding the total capabilities of the Dura-Con connector series, or for custom application assistance, contact your nearest Cinch sales representative.

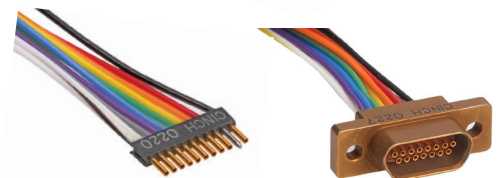
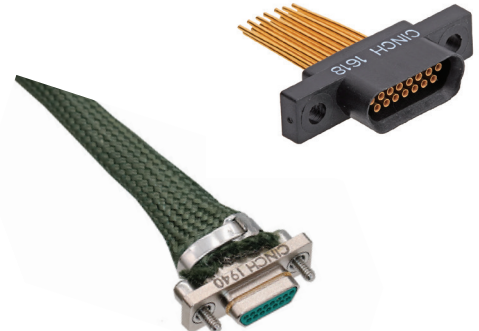

## Metal Shell Micro-D Connectors

### Features

- Both plug and socket available in 9, 15, 21, 25, 31, 37, 51, 69 and 100 positions
- Termination styles - solder cup, insulated wire and uninsulated wire
- Aluminum shell provides extra strength and EMI/RFI shielding capability. Plating options available
- Silicone elastomer compression interfacial seal protects contacts from moisture and humidity and isolates contacts from each other and the metal shell
- Designed for compliance to MIL-DTL-83513
- Rugged twist pin contacts resistant to shock and vibration make metal shell Dura-Con an excellent choice for harsh environments such as airborne or space applications
- Custom wiring with encapsulated crimped contacts available upon request.

### Ordering Information

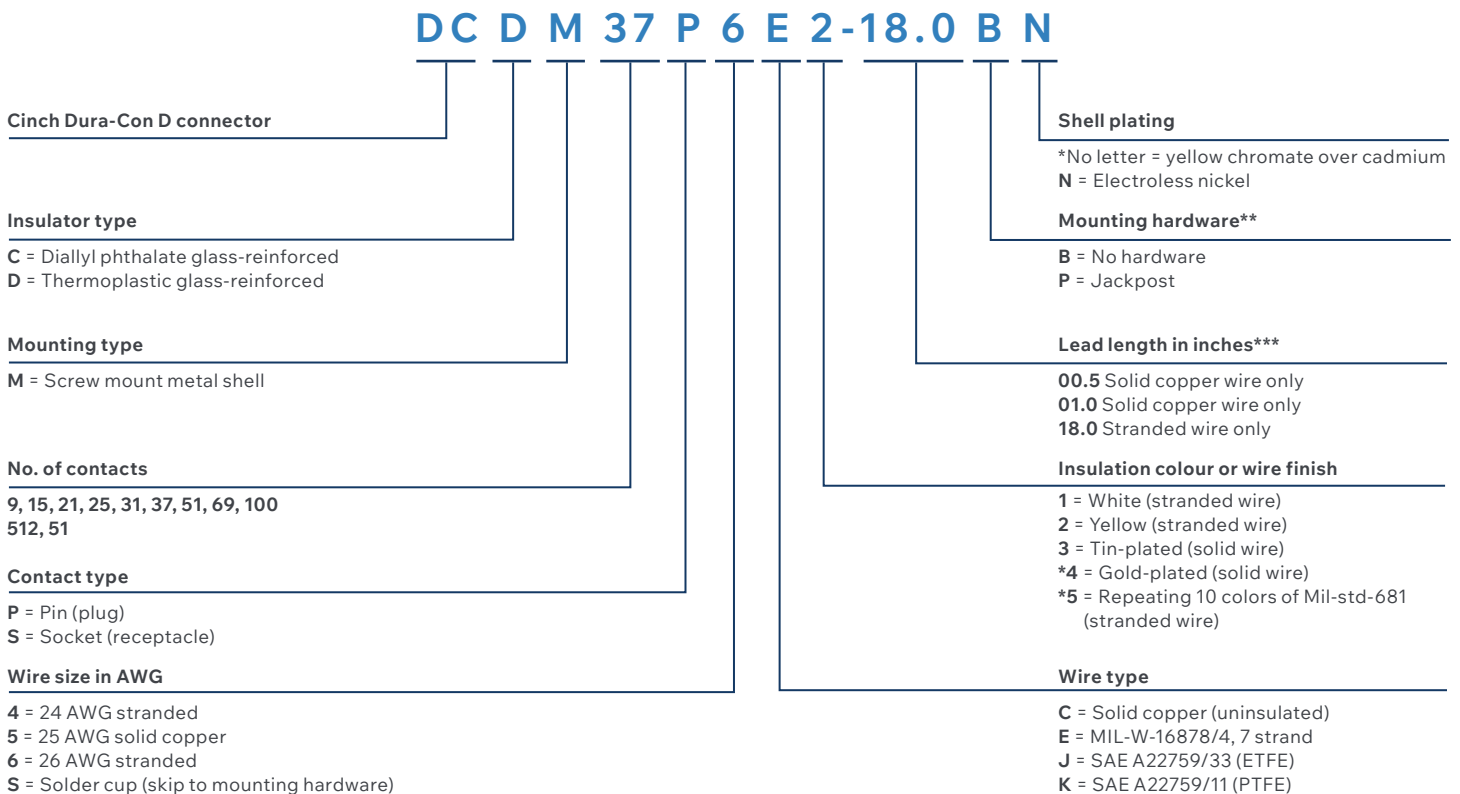

\*Indicates Cinch standard option

\*\*Reference purchasing hardware separately, page 21-22

\*\*\*Length tolerance: solid wire = ± 3/32", standard wire = ± 1/4"

## Connector Dimensions

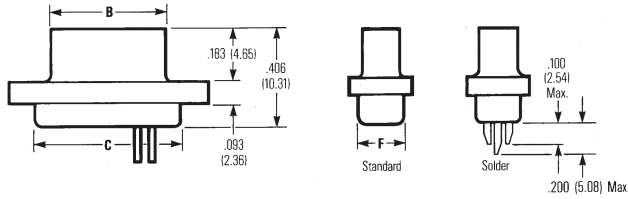
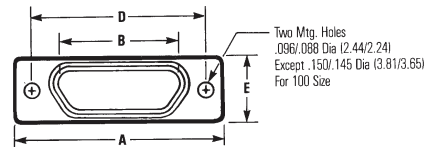
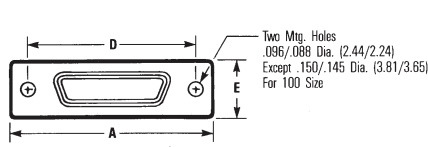

Plug

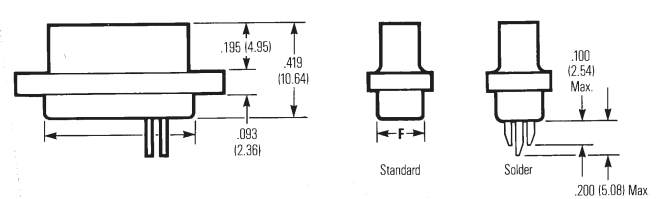

Socket

Number of Contacts	A		B		C		D		E		F	
	±0.010 (0.254)		Maximum		+0.010 (0.254) -0.018 (0.457)		±0.005 (0.127)		±0.010 (0.254)		Maximum	
	in	mm	in	mm	in	mm	in	mm	in	mm	in	mm
9 Plug	0.775	19.68	0.333	8.46	0.390	9.91	0.565	14.35	0.298	7.57	0.270	6.86
9 Socket	0.775	19.68	0.396	10.06	0.390	9.91	0.565	14.35	0.298	7.57	0.270	6.86
15 Plug	0.925	23.50	0.483	12.27	0.540	13.72	0.715	18.16	0.298	7.57	0.270	6.86
15 Socket	0.925	23.50	0.546	13.87	0.540	13.72	0.715	18.16	0.298	7.57	0.270	6.86
21 Plug	1.075	27.30	0.633	16.08	0.690	17.53	0.865	21.97	0.298	7.57	0.270	6.86
21 Socket	1.075	27.30	0.696	17.68	0.690	17.53	0.865	21.97	0.298	7.57	0.270	6.86
25 Plug	1.175	29.84	0.733	18.62	0.790	20.07	0.965	24.51	0.298	7.57	0.270	6.86
25 Socket	1.175	29.84	0.796	20.22	0.790	20.07	0.965	24.51	0.298	7.57	0.270	6.86
31 Plug	1.325	33.66	0.883	21.16	0.940	23.88	1.115	28.32	0.298	7.57	0.270	6.86
31 Socket	1.325	33.66	0.946	24.03	0.940	23.88	1.115	28.32	0.298	7.57	0.270	6.86
37 Plug	1.475	37.46	1.033	26.24	1.090	27.69	1.265	32.13	0.298	7.57	0.270	6.86
37 Socket	1.475	37.46	1.096	27.84	1.090	27.69	1.265	32.13	0.298	7.57	0.270	6.86
51 Plug	1.425	36.20	0.983	24.97	1.040	26.42	1.215	30.86	0.341	8.66	0.310	7.87
51 Socket	1.425	36.20	1.046	26.57	1.040	26.42	1.215	30.86	0.341	8.66	0.310	7.87
69 Plug	1.726	43.84	1.284	32.61	1.332	33.83	1.515	38.48	0.333	8.46	0.310	7.87
69 Socket	1.726	43.84	1.350	34.29	1.332	33.83	1.515	38.48	0.341	8.66	0.310	7.87
100 Plug	2.160	54.86	1.383	35.13	1.432	36.38	1.800	45.71	0.384	9.75	0.360	9.15
100 Socket	2.160	54.86	1.446	36.73	1.432	36.38	1.800	45.71	0.384	9.75	0.360	9.15

## Plastic Shell Micro-D Connectors

### Features

- Economical all plastic shell for lightweight applications where no shielding is required
- Both plug and socket available in 9, 15, 21, 25, 31, 37, and 51 positions
- Termination styles - solder cup, uninsulated solid wire, and insulated stranded wire
- Designed for compliance to MIL-C-83513
- Low profile shell

### Ordering Information

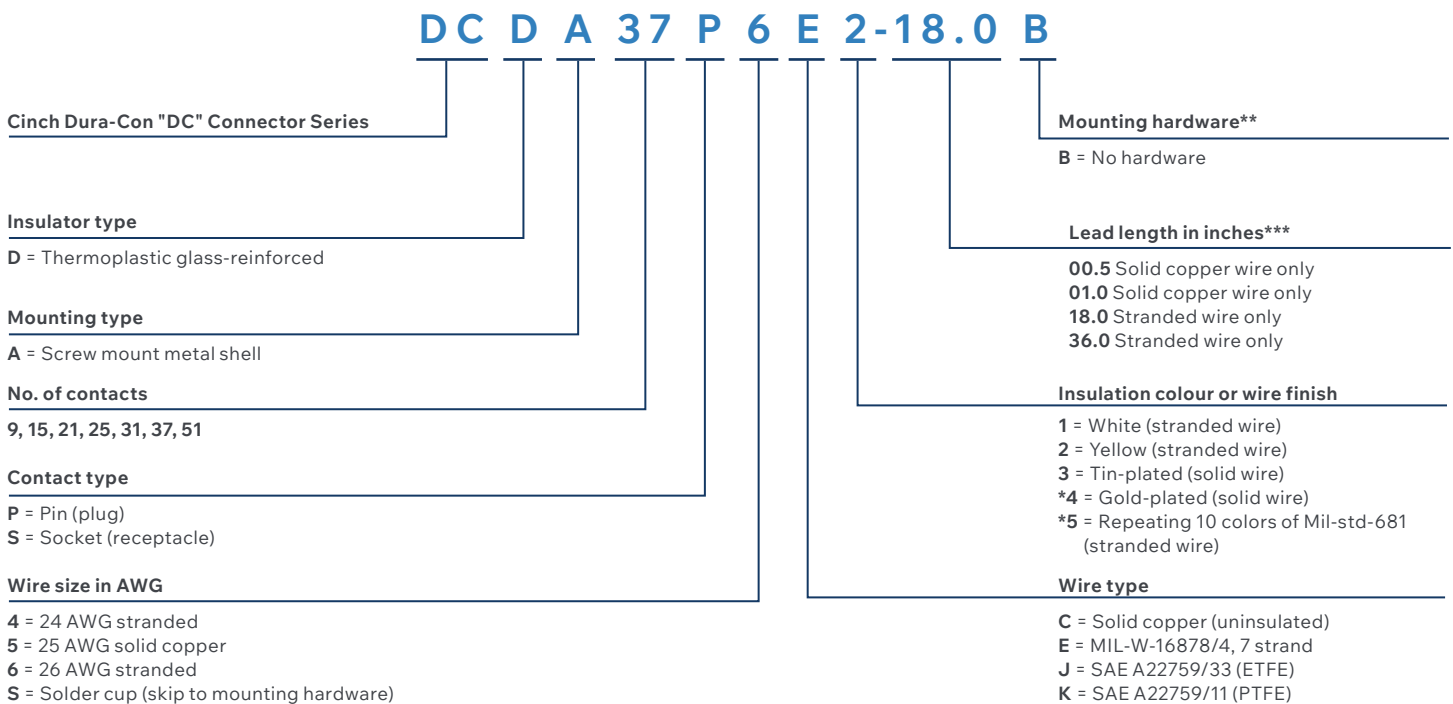

\*

*Indicates Cinch standard option*

*\*\*Reference purchasing hardware separately, page 21-22*

*\*\*\* Length tolerance: solid wire = ± 3/32"; standard wire = ± 1/4"*

## Connector Dimensions

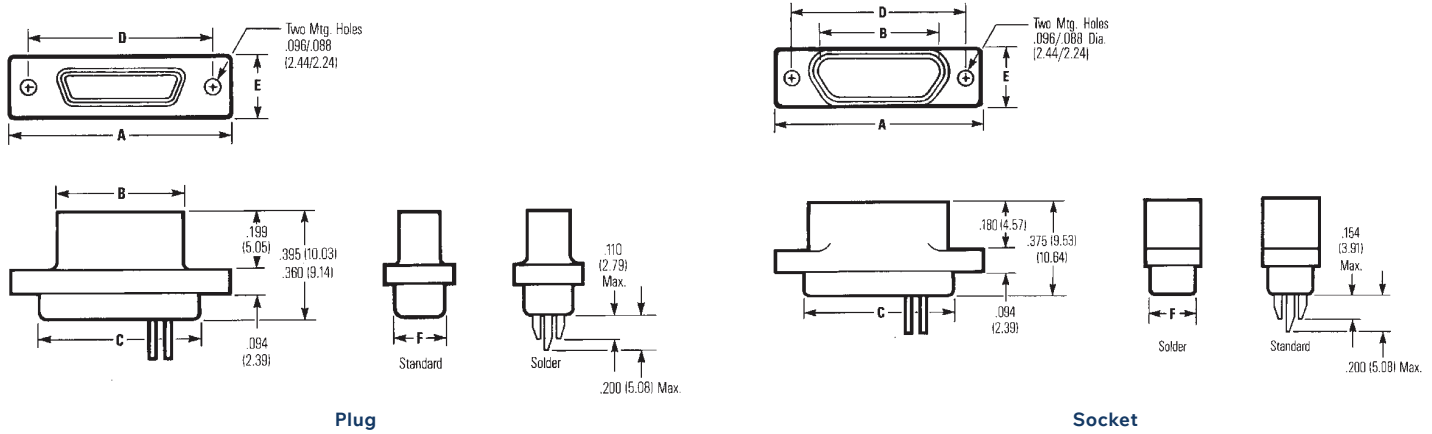

Plug

Socket

Number of Contacts	A ±0.010 (0.254)		B Maximum		C +0.010 (0.254) -0.018 (0.457)		D ±0.005 (0.127)		E ±0.010 (0.254)		F Maximum	
	in	mm	in	mm	in	mm	in	mm	in	mm	in	mm
9 Plug	0.778	19.76	0.292	7.42	0.398	10.11	0.565	14.35	0.208	5.28	0.173	4.39
9 Socket	0.778	19.76	0.376	9.55	0.398	10.11	0.565	14.35	0.208	5.28	0.173	4.39
15 Plug	0.928	23.57	0.442	11.23	0.548	13.92	0.715	18.16	0.208	5.28	0.173	4.39
15 Socket	0.928	23.57	0.526	13.36	0.548	13.92	0.715	18.16	0.208	5.28	0.173	4.39
21 Plug	1.078	27.38	0.592	15.04	0.698	17.73	0.865	21.97	0.208	5.28	0.173	4.39
21 Socket	1.078	27.38	0.676	17.17	0.698	17.73	0.865	21.97	0.208	5.28	0.173	4.39
25 Plug	1.178	29.92	0.692	17.58	0.798	20.27	0.965	24.51	0.208	5.28	0.173	4.39
25 Socket	1.178	29.92	0.776	19.71	0.798	20.27	0.965	24.51	0.208	5.28	0.173	4.39
31 Plug	1.328	33.73	0.842	21.39	0.948	24.08	1.115	28.32	0.208	5.28	0.173	4.39
31 Socket	1.328	33.73	0.926	23.52	0.948	24.08	1.115	28.32	0.208	5.28	0.173	4.39
37 Plug	1.478	37.54	0.992	25.20	1.098	27.89	1.265	32.13	0.208	5.28	0.173	4.39
37 Socket	1.478	37.54	1.076	27.33	1.098	27.89	1.265	32.13	0.208	5.28	0.173	4.39
51 Plug	1.428	36.27	0.942	23.93	1.048	26.62	1.215	30.86	0.250	6.35	0.220	5.59
51 Socket	1.428	36.27	1.026	26.06	1.048	26.62	1.215	30.86	0.250	6.35	0.220	5.59

## Metal Shell Micro-D Connectors for PCBs

### Features

- Plug & socket versions available in 9, 15, 21, 25, 31, 37, 51, and 100 positions
- Flow-through design facilitates inspection and cleaning after soldering
- All terminal block connectors use standard mounting hardware
- Metal shell provides EMI/RFI shielding capability
- Available in 3 styles: straight mount, 90° right-angle mount, and 90° right-angle narrow profile mounting
- Silicone elastomer interfacial seal protects contacts from moisture and isolates them from each other and from the metal shell
- Designed for compliance to MIL-C-83513
- Choice of insulator materials

### Ordering Information

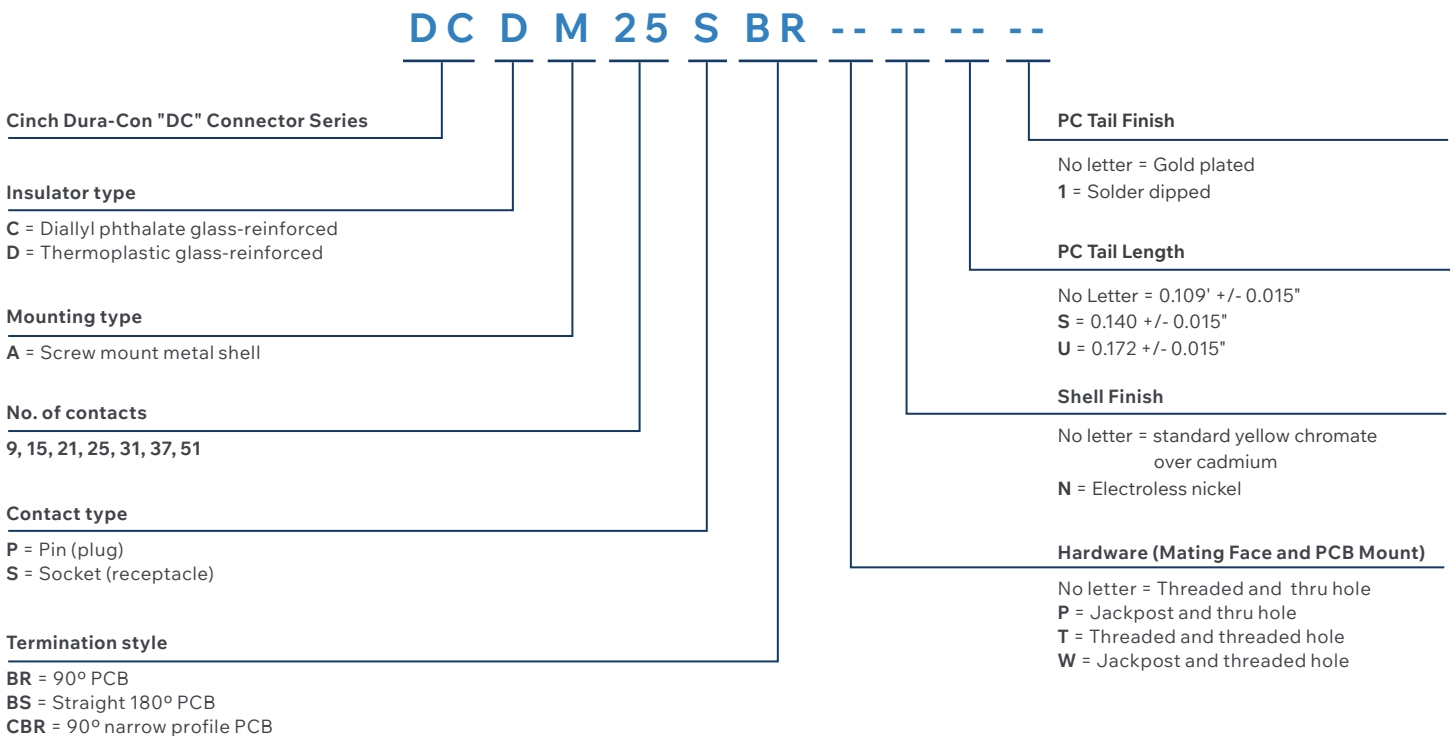

\* Indicates Cinch standard option

\*\* Reference purchasing hardware separately, page 21-22

\*\*\* Length tolerance: solid wire = ± 3/32", standard wire = ± 1/4"



## 90° Termination

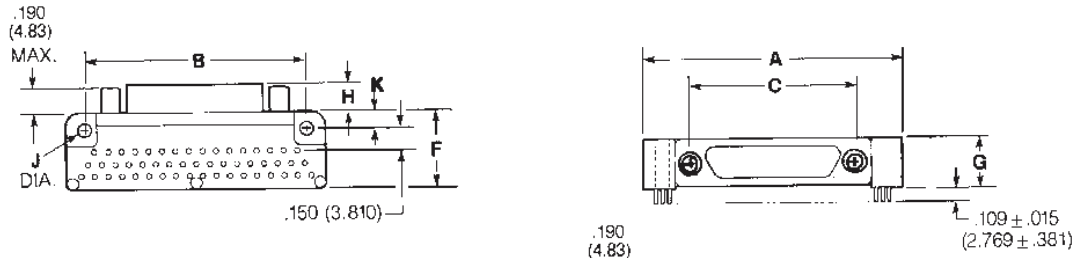

**Recommended Board Layout** (as viewed from bottom of terminal block)  
 Typical Hole Diameter = 0.040" (1.02 mm)

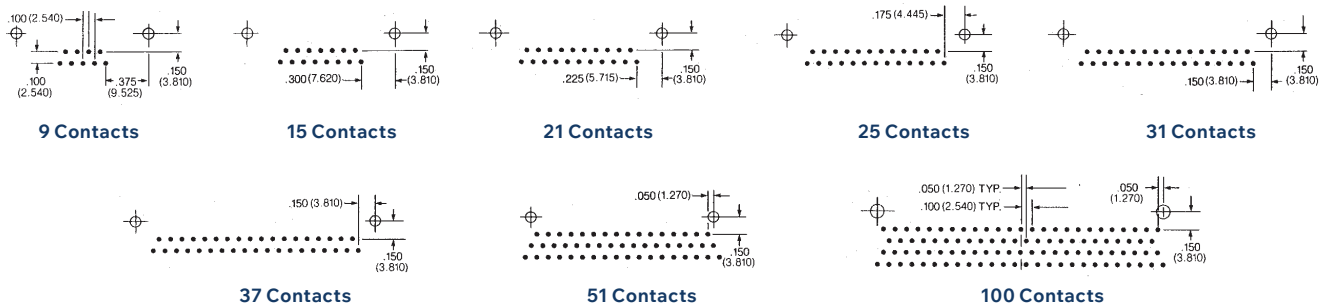

**NOTE:**

1. For additional connector dimensions, see Appendix D
2. See Board Pin Assignments in Appendix

Number of Contacts	A		B		C		F		G		H		J		K	
	Maximum		±0.007 (0.18)		±0.005 (0.13)		Maximum		Maximum		Maximum		±0.005 (0.13)		±0.015 (0.38)	
	in	mm	in	mm	in	mm	in	mm	in	mm	in	mm	in	mm	in	mm
9 Plug	1.390	35.31	1.150	29.21	0.565	14.35	0.465	11.81	0.308	7.82	0.190	4.83	0.096	2.44	0.125	3.18
9 Socket	1.390	35.31	1.150	29.21	0.565	14.35	0.465	11.81	0.308	7.82	0.200	5.08	0.096	2.44	0.125	3.18
15 Plug	1.540	39.12	1.300	33.02	0.715	18.16	0.465	11.81	0.308	7.82	0.190	4.83	0.096	2.44	0.125	3.18
15 Socket	1.540	39.12	1.300	33.02	0.715	18.16	0.465	11.81	0.308	7.82	0.200	5.08	0.096	2.44	0.125	3.18
21 Plug	1.690	42.93	1.450	36.83	0.865	21.97	0.465	11.81	0.308	7.82	0.190	4.83	0.096	2.44	0.125	3.18
21 Socket	1.690	42.93	1.450	36.83	0.865	21.97	0.465	11.81	0.308	7.82	0.200	5.08	0.096	2.44	0.125	3.18
25 Plug	1.790	45.47	1.550	39.37	0.965	24.51	0.465	11.81	0.308	7.82	0.190	4.83	0.096	2.44	0.125	3.18
25 Socket	1.790	45.47	1.550	39.37	0.965	24.51	0.465	11.81	0.308	7.82	0.200	5.08	0.096	2.44	0.125	3.18
31 Plug	2.040	51.82	1.800	45.72	1.115	28.32	0.465	11.81	0.308	7.82	0.190	4.83	0.096	2.44	0.125	3.18
31 Socket	2.040	51.82	1.800	45.72	1.115	28.32	0.465	11.81	0.308	7.82	0.200	5.08	0.096	2.44	0.125	3.18
37 Plug	2.340	59.44	2.100	53.34	1.265	32.13	0.465	11.81	0.308	7.82	0.190	4.83	0.096	2.44	0.125	3.18
37 Socket	2.340	59.44	2.100	53.34	1.265	32.13	0.465	11.81	0.308	7.82	0.200	5.08	0.096	2.44	0.125	3.18
51 Plug	1.875	47.63	1.600	40.64	1.215	30.86	0.565	14.35	0.351	8.92	0.190	4.83	0.096	2.44	0.125	3.18
51 Socket	1.875	47.63	1.600	40.64	1.215	30.86	0.565	14.35	0.351	8.92	0.200	5.08	0.096	2.44	0.125	3.18
100 Plug	2.780	70.61	2.500	63.50	1.800	45.72	0.765	19.43	0.394	10.00	0.190	4.83	0.125	3.18	0.225	5.72
100 Socket	2.780	70.61	2.500	63.50	1.800	45.72	0.765	19.43	0.394	10.00	0.200	5.08	0.125	3.18	0.225	5.72

# Dura-Con™ Micro-D Connectors

## Straight (180°) Termination

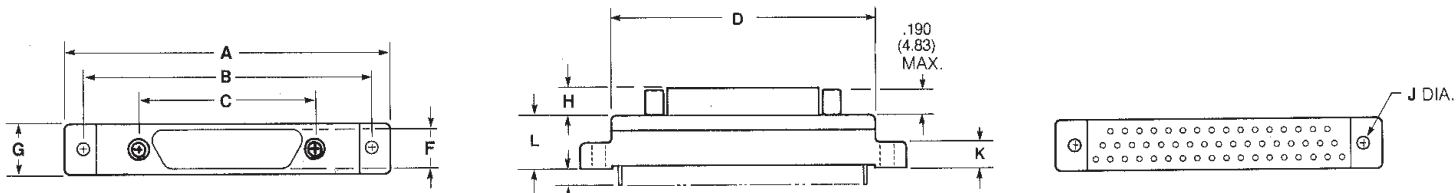

### Recommended Board Layout (as viewed from bottom of terminal block)

Typical Hole Diameter = 0.040" (1.02 mm)

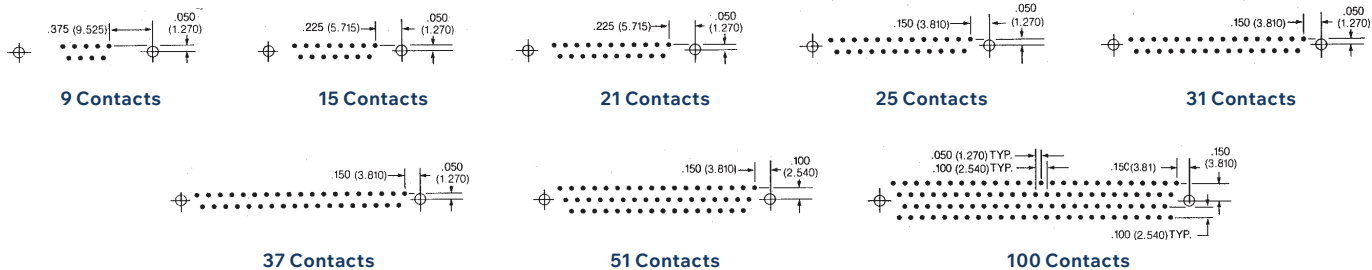

### NOTE:

1. For additional connector dimensions, see Appendix D
2. See Board Pin Assignments in Appendix

Number of Contacts	A		B		C		D		G		H		J		K		L			
	Maximum	±0.007 (0.18)	±0.007 (0.18)	±0.007 (0.18)	±0.005 (0.13)	±0.005 (0.13)	Maximum	Maximum	Maximum	Maximum	Maximum	Maximum	±0.005 (0.13)	±0.005 (0.13)	Maximum	Maximum	Maximum	Maximum		
	in	mm	in	mm	in	mm	in	mm	in	mm	in	mm	in	mm	in	mm	in	mm	in	mm
9 Plug	1.390	35.31	1.150	29.21	0.565	14.35	0.885	22.48	0.308	7.75	0.190	4.83	0.096	2.44	0.165	4.19	0.355	9.02		
9 Socket	1.390	35.31	1.150	29.21	0.565	14.35	0.885	22.48	0.308	7.75	0.200	5.08	0.096	2.44	0.165	4.19	0.355	9.02		
15 Plug	1.390	35.31	1.150	29.21	0.715	18.16	0.945	24.0	0.308	7.75	0.190	4.83	0.096	2.44	0.165	4.19	0.355	9.02		
15 Socket	1.390	35.31	1.150	29.21	0.715	18.16	0.945	24.0	0.308	7.75	0.200	5.08	0.096	2.44	0.165	4.19	0.355	9.02		
21 Plug	1.690	42.93	1.450	36.83	0.865	21.97	1.185	30.09	0.308	7.75	0.190	4.83	0.096	2.44	0.165	4.19	0.355	9.02		
21 Socket	1.690	42.93	1.450	36.83	0.865	21.97	1.185	30.09	0.308	7.75	0.200	5.08	0.096	2.44	0.165	4.19	0.355	9.02		
25 Plug	1.740	44.20	1.500	38.10	0.965	24.51	1.275	32.38	0.308	7.75	0.190	4.83	0.096	2.44	0.165	4.19	0.355	9.02		
25 Socket	1.740	44.20	1.500	38.10	0.965	24.51	1.275	32.38	0.308	7.75	0.200	5.08	0.096	2.44	0.165	4.19	0.355	9.02		
31 Plug	2.040	51.82	1.800	45.72	1.115	28.32	1.575	40.00	0.308	7.75	0.190	4.83	0.096	2.44	0.165	4.19	0.355	9.02		
31 Socket	2.040	51.82	1.800	45.72	1.115	28.32	1.575	40.00	0.308	7.75	0.200	5.08	0.096	2.44	0.165	4.19	0.355	9.02		
37 Plug	2.340	59.44	2.100	53.34	1.265	32.13	1.875	47.62	0.308	7.75	0.190	4.83	0.096	2.44	0.165	4.19	0.355	9.02		
37 Socket	2.340	59.44	2.100	53.34	1.265	32.13	1.875	47.62	0.308	7.75	0.200	5.08	0.096	2.44	0.165	4.19	0.355	9.02		
51 Plug	2.270	57.66	2.000	50.80	1.215	30.86	1.775	45.08	0.351	8.92	0.190	4.83	0.096	2.44	0.165	4.19	0.355	9.02		
51 Socket	2.270	57.66	2.000	50.80	1.215	30.86	1.775	45.08	0.351	8.92	0.200	5.08	0.096	2.44	0.165	4.19	0.355	9.02		
100 Plug	3.070	77.98	2.800	71.12	1.800	45.72	2.585	65.55	0.455	11.56	0.190	4.83	0.125	3.18	0.300	7.62	0.550	13.97		
100 Socket	3.070	77.98	2.800	71.12	1.800	45.72	2.585	65.65	0.455	11.56	0.200	5.08	0.125	3.18	0.300	7.62	0.550	13.97		

## 90° Narrow Termination

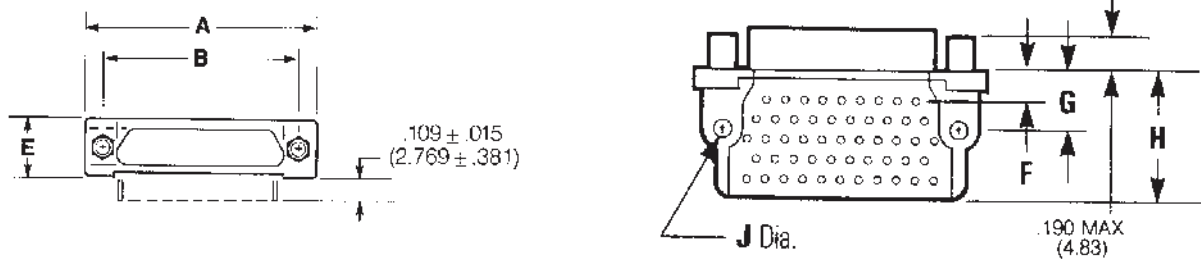

**Recommended Board Layout** (as viewed from bottom of terminal block)  
 Typical Hole Diameter = 0.040" (1.02 mm)

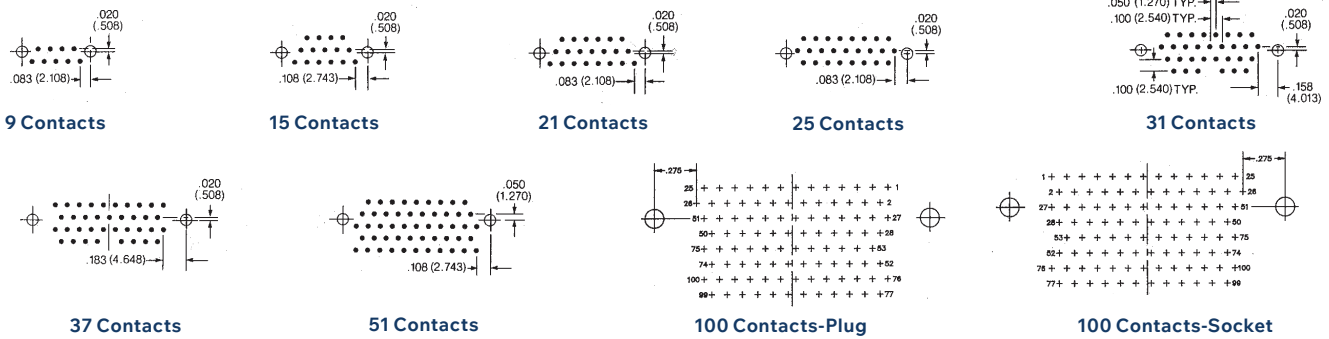

**NOTE:**

1. For additional connector dimensions, see Appendix D
2. See Board Pin Assignments in Appendix

Number of Contacts	A		B		E		F		G		H		J	
	Maximum		$\pm 0.005$ (0.13)		Maximum		$\pm 0.010$ (0.25)		$\pm 0.010$ (0.25)		Maximum		$\pm 0.005$ (0.13)	
	in	mm	in	mm	in	mm	in	mm	in	mm	in	mm	in	mm
9 Plug	0.785	19.94	0.565	14.35	0.308	7.82	0.230	5.84	0.250	6.35	0.420	10.67	0.096	2.44
9 Socket	0.785	19.94	0.565	14.35	0.308	7.82	0.230	5.84	0.250	6.35	0.420	10.67	0.096	2.44
15 Plug	0.935	23.75	0.715	18.16	0.308	7.82	0.130	3.30	0.250	6.35	0.420	10.67	0.096	2.44
15 Socket	0.935	23.75	0.715	18.16	0.308	7.82	0.130	3.30	0.250	6.35	0.420	10.67	0.096	2.44
21 Plug	1.085	27.56	0.865	21.97	0.308	7.82	0.130	3.30	0.250	6.35	0.420	10.67	0.096	2.44
21 Socket	1.085	27.56	0.865	21.97	0.308	7.82	0.130	3.30	0.250	6.35	0.420	10.67	0.096	2.44
25 Plug	1.085	30.10	0.965	24.51	0.308	7.82	0.130	3.30	0.250	6.35	0.420	10.67	0.096	2.44
25 Socket	1.185	30.10	0.965	24.51	0.308	7.82	0.130	3.30	0.250	6.35	0.420	10.67	0.096	2.44
31 Plug	1.335	33.91	1.115	28.32	0.308	7.82	0.130	3.30	0.250	6.35	0.520	13.21	0.096	2.44
31 Socket	1.335	33.91	1.115	28.32	0.308	7.82	0.130	3.30	0.250	6.35	0.520	13.21	0.096	2.44
37 Plug	1.485	37.72	1.265	32.13	0.308	7.82	0.130	3.30	0.250	6.35	0.520	13.21	0.096	2.44
37 Socket	1.485	37.72	1.265	32.13	0.308	7.82	0.130	3.30	0.250	6.35	0.520	13.21	0.096	2.44
51 Plug	1.435	36.45	1.215	30.86	0.351	8.92	0.150	3.81	0.300	7.62	0.650	16.51	0.096	2.44
51 Socket	1.435	36.45	1.215	30.86	0.351	8.92	0.150	3.81	0.300	7.62	0.650	16.51	0.096	2.44
100 Plug	2.175	55.25	1.800	45.72	0.394	10.00	0.200	5.08	0.400	10.16	1.000	25.40	0.125	3.18
100 Socket	2.175	55.25	1.800	45.72	0.394	10.00	0.200	5.08	0.400	10.16	1.000	25.40	0.125	3.18

## Hermetically Sealed Micro-D Connectors

### Features

- Straight and right angle mounted hermetic Micro-Ds available
- Both plug and socket available in 9, 15, 21, 25, 31, 37 and 51 positions
- Aluminium shell provides extra strength and EMI/RFI shielding capability
- Rugged twist pin contacts resistant to shock and vibration make metal shell Dura-Con an excellent choice for harsh environments
- Hermetic seal achieved through Cinch proprietary epoxy-metallic compound
- Performs to MIL-DTL-83513

### Ordering Information

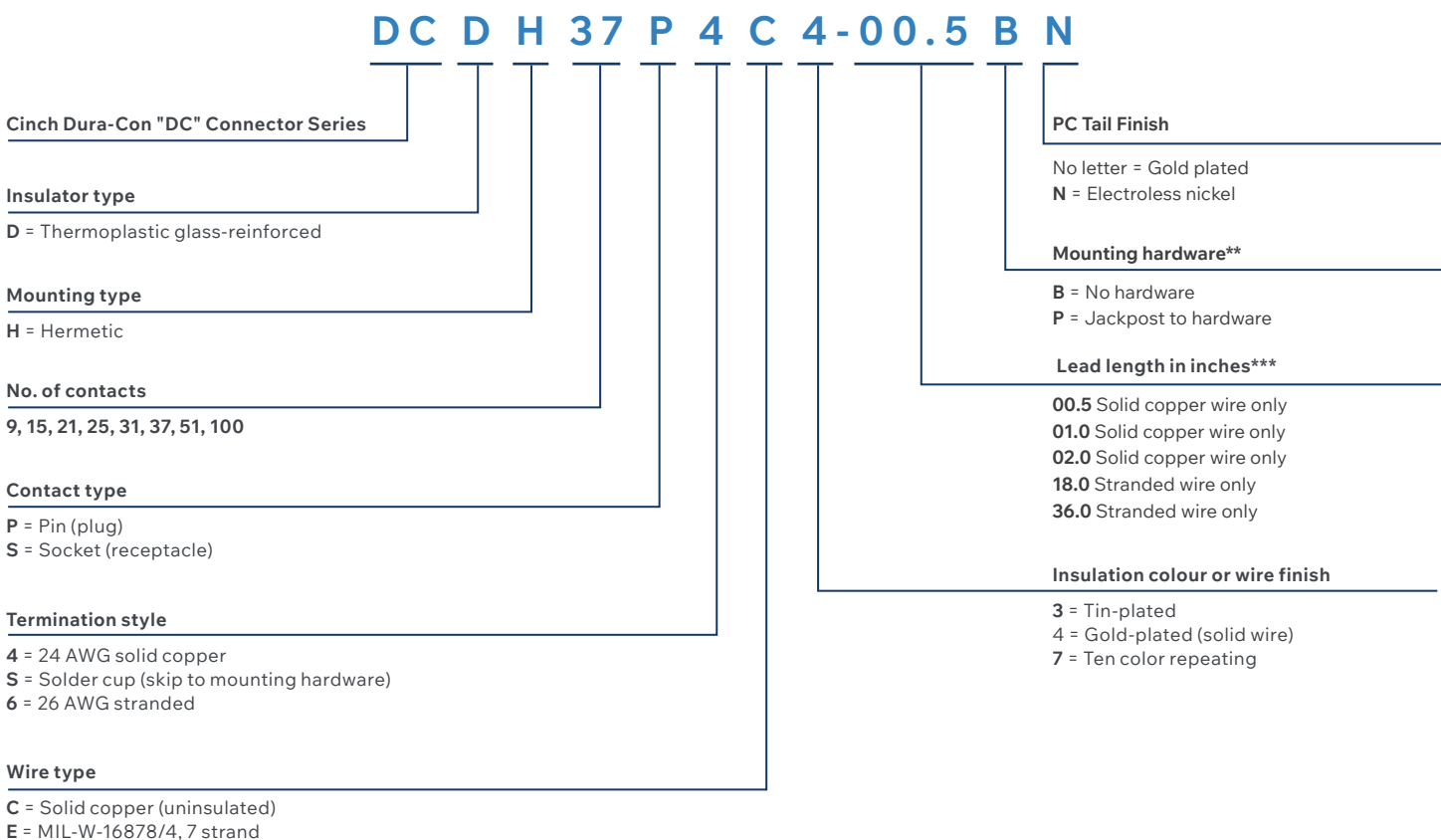

\* Indicates Cinch standard option

\*\* Reference purchasing hardware separately, page 21-22

\*\*\* Length tolerance: solid wire = ± 3/32", standard wire = ± 1/4"

## Plug Arrangement

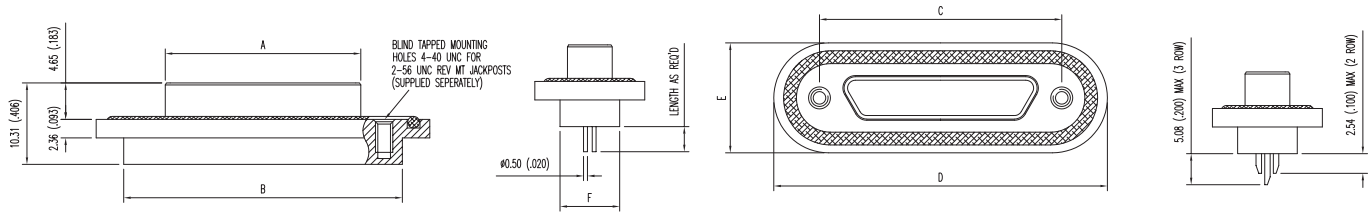

## Socket Arrangement

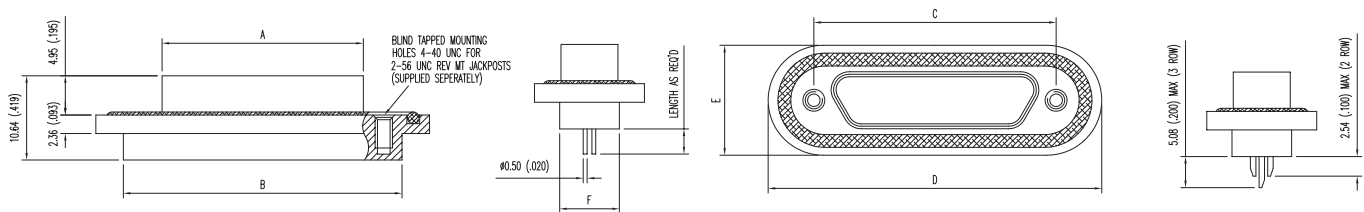

**NOTE:**

Connector Dimensions - Mating view of pin insert.  
Use reverse order for socket side.

Number of Contacts	A Maximum		B ± 0.010" (0.25mm)		C ± 0.005" (0.127mm)		D ± 0.008" (0.20mm)		E ± 0.008" (0.20mm)		F ± 0.008" (0.20mm)	
	in	mm	in	mm	in	mm	in	mm	in	mm	in	mm
9 Plug	0.333	8.4	0.774	19.65	0.565	14.35	1.247	31.68	0.670	17.00	0.295	7.50
9 Socket	0.396	10.06	0.774	19.65	0.565	14.35	1.247	31.68	0.670	17.00	0.295	7.50
15 Plug	0.483	12.27	0.923	23.45	0.715	18.16	1.345	34.16	0.670	17.00	0.295	7.50
15 Socket	0.546	13.87	0.923	23.45	0.715	18.16	1.345	34.16	0.670	17.00	0.295	7.50
21 Plug	0.633	16.08	1.073	27.25	0.865	21.97	1.541	39.15	0.670	17.00	0.295	7.50
21 Socket	0.696	17.68	1.073	27.25	0.865	21.97	1.541	39.15	0.670	17.00	0.295	7.50
25 Plug	0.733	18.62	1.175	29.85	0.965	24.51	1.640	41.66	0.670	17.00	0.295	7.50
25 Socket	0.796	20.22	1.175	29.85	0.965	24.51	1.640	41.66	0.670	17.00	0.295	7.50
31 Plug	0.883	21.16	1.325	33.65	1.115	28.32	1.737	44.13	0.670	17.00	0.295	7.50
31 Socket	0.946	24.03	1.325	33.65	1.115	28.32	1.737	44.13	0.670	17.00	0.295	7.50
37 Plug	1.033	26.24	1.474	37.45	1.265	32.13	1.934	49.12	0.670	17.00	0.295	7.50
37 Socket	1.096	27.84	1.474	37.45	1.265	32.13	1.934	49.12	0.670	17.00	0.295	7.50
51 Plug	0.983	24.97	1.423	36.15	1.215	30.86	1.909	48.50	0.713	18.10	0.339	8.60
51 Socket	1.046	26.57	1.423	36.15	1.215	30.86	1.909	48.50	0.713	18.10	0.339	8.60
100 Plug	Consult Cinch Connectivity Solutions for information											
100 Socket	Consult Cinch Connectivity Solutions for information											

# Dura-Con™ Micro-D Connectors

## Hermetic Hardware

For tightening jackpost (4-40 UNC) into connector, 0.45 Nm / 0.55 Nm (4/5 in lb) recommended torque for tightening jackscrew of mating connector (2-56 UNC) into jackpost, 0.23 Nm / 0.28 Nm (2/2.5 in lb)

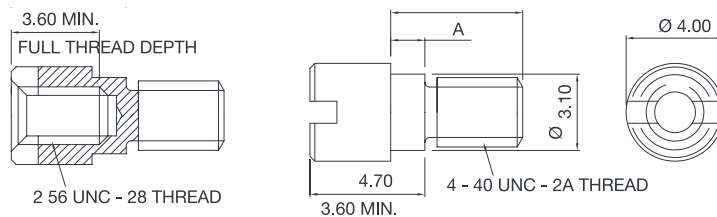

Jackpost Part Number	Panel Thickness		A		B	
	in	mm	in	mm	in	mm
DN00008 08	0.031	0.8	0.026/0.024	0.65/0.60	0.181	4.6
DN00008 12	0.047	1.2	0.041/0.039	1.05/1.00	0.197	5.0
DN00008 16	0.063	1.6	0.057/0.055	1.45/1.40	0.213	5.4
DN00008 24	0.094	2.4	0.089/0.087	2.25/2.20	0.244	6.2

## Panel Mounting Details (Rear Mount Only)

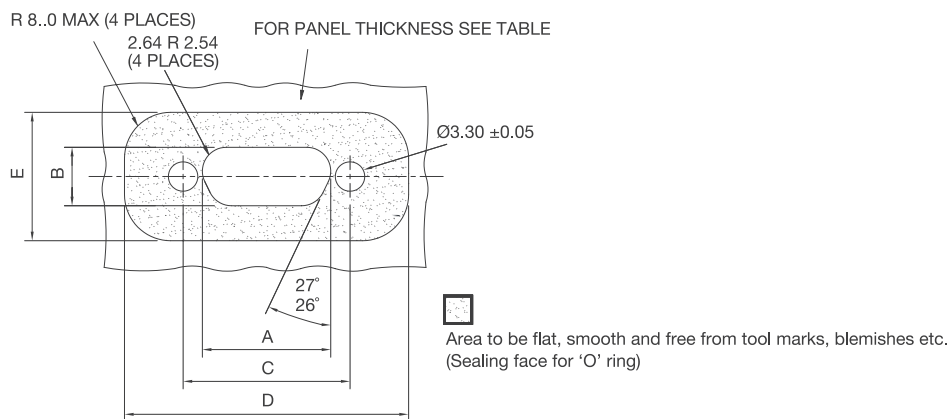

Number Ways	A +0.10 (0.004)		B +0.10 (0.004)		C ±0.05 (0.002)		D Minimum		E Minimum	
	in	mm	in	mm	in	mm	in	mm	in	mm
9	0.398	10.11	0.249	6.32	0.565	14.35	1.378	35.0	0.787	20.0
15	0.548	13.92	0.249	6.32	0.715	18.16	1.457	37.0	0.787	20.0
21	0.698	17.73	0.249	6.32	0.865	21.97	1.654	42.0	0.787	20.0
25	0.798	20.27	0.249	6.32	0.965	24.51	1.772	45.0	0.787	20.0
31	0.948	24.08	0.249	6.32	1.116	28.34	1.850	47.0	0.787	20.0
37	1.098	27.89	0.249	6.32	1.265	32.13	2.047	52.0	0.787	20.0
51	1.048	26.62	0.292	7.42	1.215	30.86	2.047	52.0	0.866	22.0
100	Consult Cinch Connectivity Solutions for information									

**NOTE:**

Mating view of pin insert. Use reverse order for socket side - 9 to 51 way only.

## High Temperature Metal Shell Micro-D Connectors

### Features

- Plug materials durable to operate continuously at 175°C, sockets materials durable to 200°C
- Specially designed insulator with "raised rib" feature to prevent shorts in shock (50 Gs) and high vibration (20 Gs) conditions
- Plug & socket versions available in 9, 15, 21, 25, 31 and 37 positions
- Metal shell provides EMI/RFI shielding capability
- Plugs and sockets available with solder cups and wire leads, sockets available for straight and 90° right-angle narrow profile PCB mounting
- Silicone elastomer interfacial seal protects contacts from moisture and isolates them for each other and from the metal shell
- Designed for compliance to MIL-C-83513

### Ordering Information

## DC H M XX P 6 N 6-36.0 B N-HT1

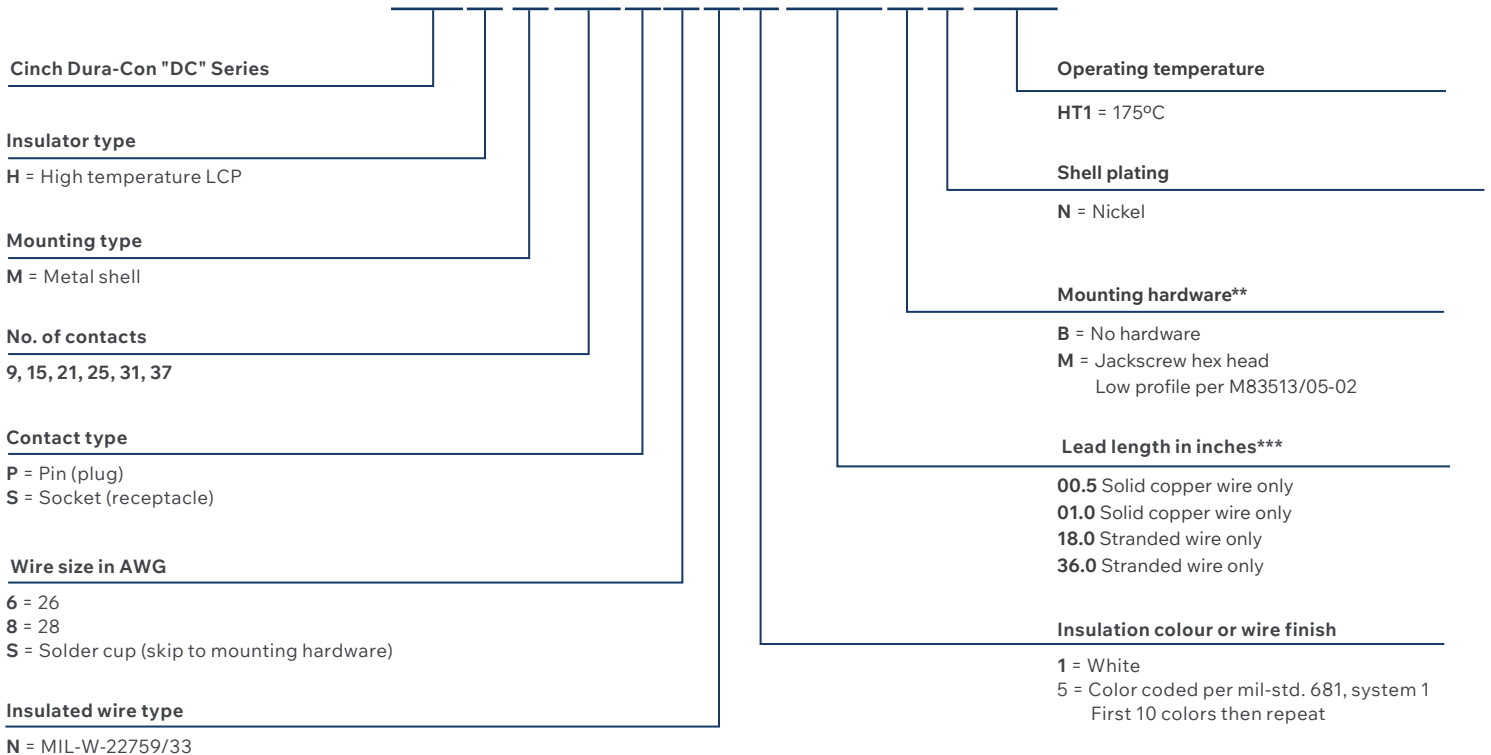

\* Indicates Cinch standard option

\*\* Reference purchasing hardware separately, page 21-22

See p. 33 for mil spec. hardware, both sold separately

\*\*\* Length tolerance: solid wire = ± 3/32", standard wire = ± 1/4"

# Dura-Con™ Micro-D Connectors

## Shell Dimensions

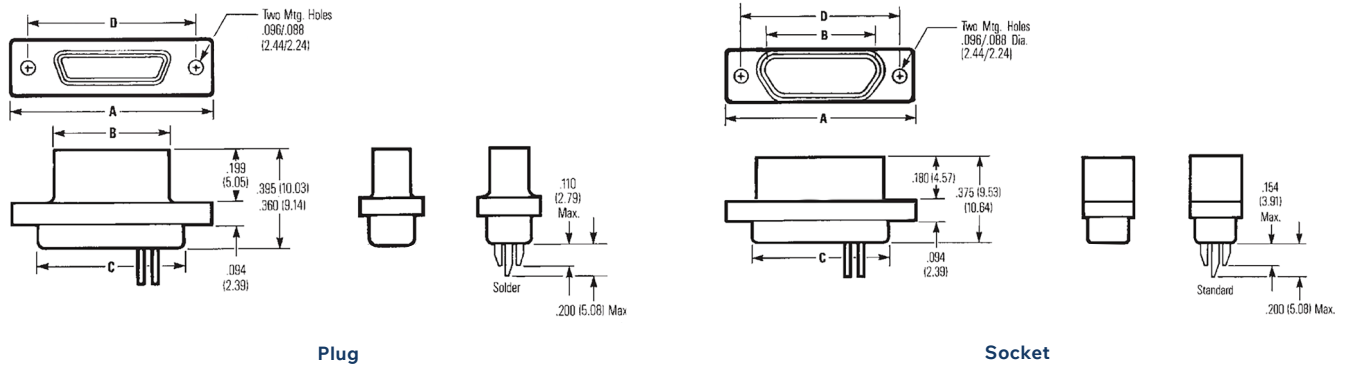

Number of Contacts	A Maximum		B Maximum		C Maximum		D Nominal	
	in	mm	in	mm	in	mm	in	mm
9 Plug	0.785	19.94	0.334	8.48	0.400	10.16	0.565	14.35
9 Socket	0.785	19.94	0.397	10.08	0.400	10.16	0.565	14.35
15 Plug	0.935	23.74	0.484	12.29	0.550	13.97	0.715	18.16
15 Socket	0.935	23.74	0.547	13.89	0.550	13.97	0.715	18.16
21 Plug	1.085	27.56	0.634	16.10	0.700	17.78	0.865	21.97
21 Socket	1.085	27.56	0.697	17.70	0.700	17.78	0.865	21.97
25 Plug	1.185	30.10	0.734	18.64	0.800	20.32	0.965	24.51
25 Socket	1.185	30.10	0.797	20.24	0.800	20.32	0.965	24.51
31 Plug	1.335	33.97	0.884	22.45	0.950	24.13	1.115	28.32
31 Socket	1.335	33.97	0.947	24.05	0.950	24.13	1.115	28.32
37 Plug	1.485	37.72	1.034	26.26	1.100	27.94	1.265	32.13
37 Socket	1.485	37.72	1.097	27.86	1.100	27.94	1.265	32.13



## High Temperature Metal Shell Micro-D Connectors for PCBs

### Ordering Information

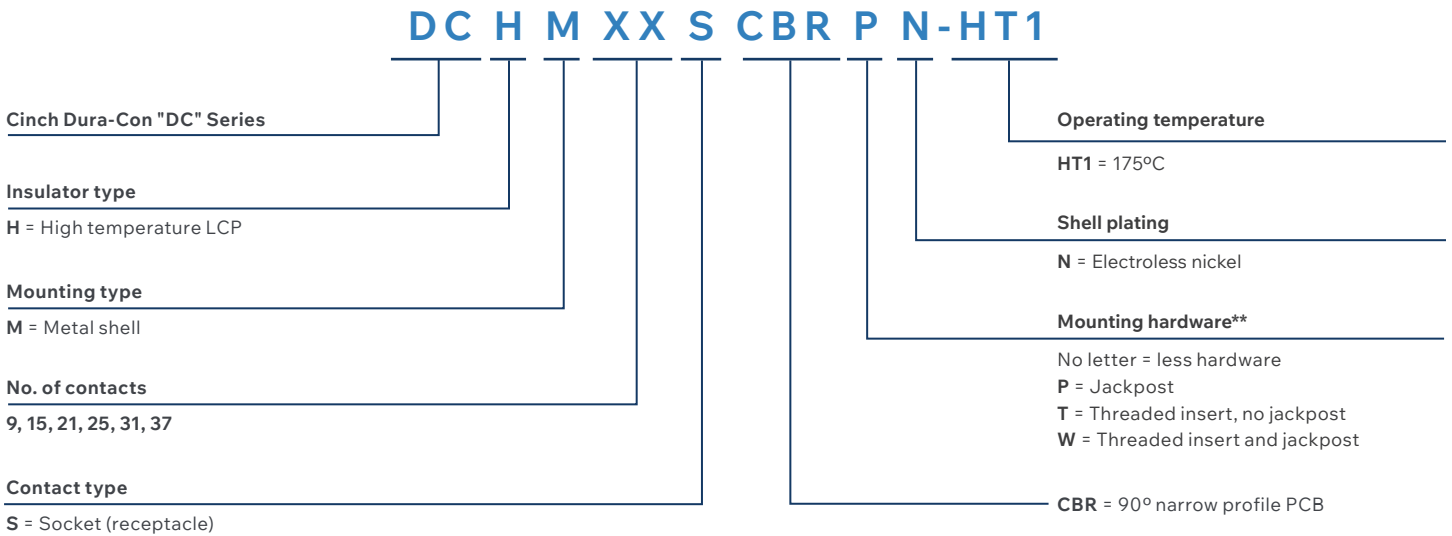

### Shell Dimensions

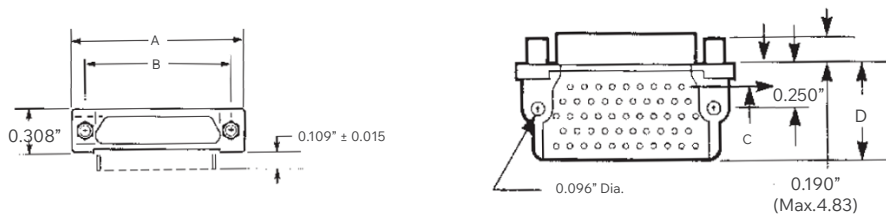

Number of Contacts	A Maximum		B		C		D Maximum	
	in	mm	in	mm	in	mm	in	mm
9 Socket	0.785	19.940	0.565	14.350	0.230	5.840	0.420	10.670
15 Socket	0.935	23.750	0.715	18.160	0.130	3.300	0.420	10.670
21 Socket	1.085	27.560	0.865	21.970	0.130	3.300	0.420	10.670
25 Socket	1.185	30.100	0.965	24.510	0.130	3.300	0.420	10.670
31 Socket	1.335	33.910	1.115	28.320	0.130	3.300	0.520	13.210
37 Socket	1.485	37.720	1.265	32.130	0.130	3.300	0.520	13.210

# Dura-Con™ Micro-D Connectors

## Micro-D Jumper Assemblies



### Features

- Twist pin contacts and machined sockets for durable, 7 points of contact
- MIL-STD-83513 compliant micro-d connectors
- Both ends of wire length pre-terminated eliminating need for additional processing
- Plug to plug, socket to socket and plug to socket options
- 18" and 36" wire lengths are standard, but additional lengths are available

### Ordering Information

**DC C M 15 PS 6 E 1 - 18.0 B N**

Cinch Dura-Con "DC" Series

#### Insulator type

C = Thermoset  
D = Thermosplastic

#### Mounting type

M = Metal shell

#### No. of contacts

9, 15, 21, 25, 31, 37, 51, 100

#### Contact type

GP = Plug to plug  
GS = Socket to socket  
PS = Plug to socket

#### Wire size

6 = #26 AWG stranded wire  
*\*Consult factory for additional sizes*

#### Shell Plating

No letter = Yellow chromate over cadmium  
N = Electroless nickel

#### Mounting Hardware

No letter = less hardware  
B = Hardware sold separately

#### Wire Length (in)\*

18.0 Stranded wire only  
36.0 Stranded wire only

#### Wire Color

1 = White  
5 = Repeating 1-10 colors of MIL-STD-681

#### Wire type

E = MIL-W-16878/4  
J = SAE A22759/33 (ETFE)  
K = SAE A22759/11 (PTFE)

### Shell Dimensions

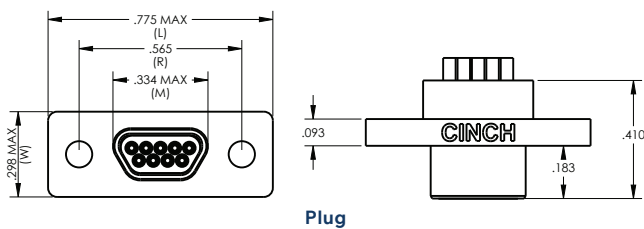

Plug

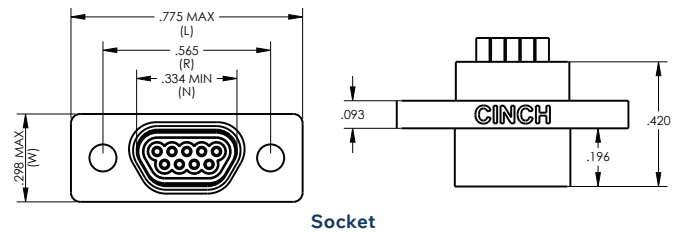

Socket

Connector Size	L	M	N	R	W
9P	0.775	0.334		0.565	0.298
15P	0.925	0.484		0.715	0.298
21P	1.075	0.634		0.865	0.298
25P	1.175	0.734		0.965	0.298
31P	1.325	0.884		1.115	0.298
37P	1.475	1.034		1.265	0.298
51P	1.425	0.984		1.215	0.341
100P	2.160	1.384		1.800	0.384

Connector Size	L	M	N	R	W
9S	0.775		0.334	0.565	0.298
15S	0.925		0.484	0.715	0.298
21S	1.075		0.634	0.865	0.298
25S	1.175		0.734	0.965	0.298
31S	1.325		0.884	1.115	0.298
37S	1.475		1.034	1.265	0.298
51S	1.425		0.984	1.215	0.341
100S	2.160		1.384	1.800	0.384

## Shielded Cable Assemblies

### Features

- Shell and contacts meets ML-DTL-83513 requirements
- EMI gasket and braided sleeves
- Integrated backshell
- Point to point jumper configurations

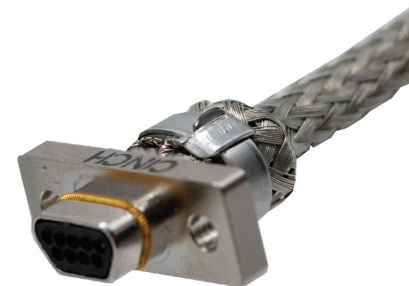

### Ordering Information

**DCDC - 9 S 6 K 5 - 18.0 A N L G**

Cinch Dura-Con "DC" Series

#### Insulator Type

C = Diallylphthalate (Glass-Reinforced)  
D = Thermoplastic (Glass-Reinforced)

#### Mounting Type

C = Cable Assembly Shell Size

#### Shell Size

9, 15, 21, 25, 31, 37, 51, 100

#### Gender

P = Plug  
S = Socket  
GP = Double Ended Plug - Plug  
GS = Double Ended Socket - Socket  
PS = Double Ended Plug - Socket

#### Wire Size (AWG)

4 = 24  
6 = 26  
8 = 28

#### Wire Type

K = SAE-AS-22759/11 (PTFE)  
J = SAE-AS-22759/33 (ETFE)

#### Insulation Color

2 = Yellow  
5 = Color Coded per MIL-STD-681 System 1

#### Insulator Type

N = No Ground Spring  
G = Ground Spring (Plug Only) Hardware

#### Hardware

B = No Hardware  
F = Float Mount  
K = Slotted Jackscrew  
L = Hexhead Jackscrew  
P = Jackpost Shell Finish

#### Shell Finish

No Designation = Cadmium  
N = Electroless Nickel

#### Termination

A = EMI Braided Shield  
C = EMI Braided Shield & Abrasion Protection Sleeve  
D = Abrasion Protection Sleeve  
N = No EMI Braided Shield & No Abrasion Protection Sleeve

#### Wire Length (Inches)

18.0 Standard Length  
36.0 Standard Length  
Additional lengths available on request

\* Indicates Cinch standard option

\*\* Reference purchasing hardware separately, page 21-22

See p. 33 for mil spec. hardware, both sold separately

\*\*\* Length tolerance: solid wire =  $\pm 3/32"$ , standard wire =  $\pm 1/4"$

# Dura-Con™ Micro-D Connectors

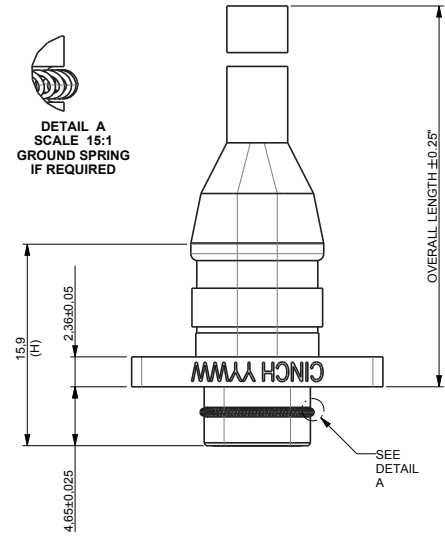
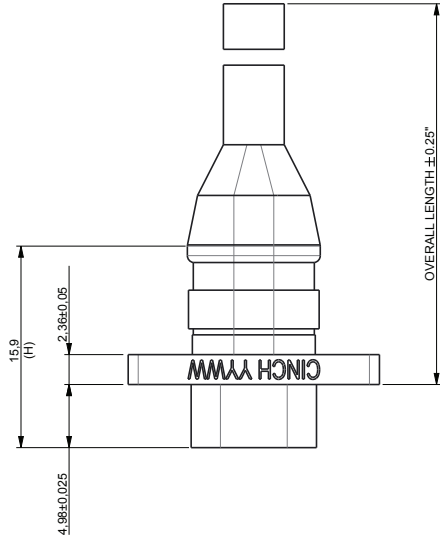
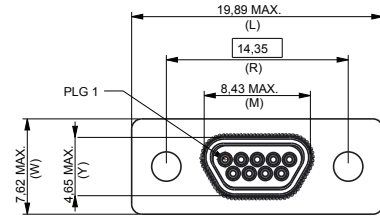
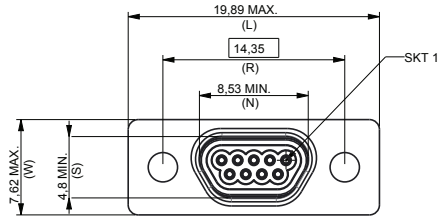

Socket Connector

Plug Connector

## Hardware

Termination Side

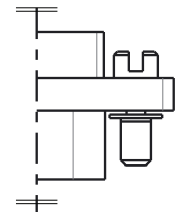
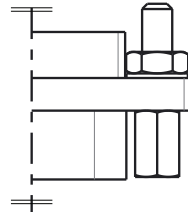
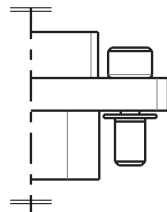
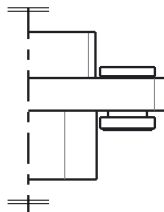

Connector Side

Float Mount F

Hexhead Jackscrew with Circlip L

Jackpost P

Jackscrew Slot Head with Circlip K

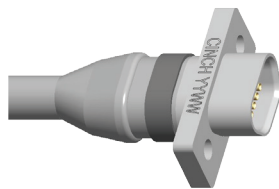

Socket Connector

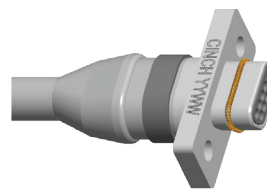

Plug Connector with EMI Gasket

# Dura-Con™ Micro-D Connectors

## Connector Savers

### Features

- Designed to significantly reduce damage to already mounted Dura-Con connectors during routine system tests
- Eliminates numerous mating and unmating cycles experienced by connectors on test harnesses
- Plug connector on one end, socket connector on the other
- Available in all-plastic (polyester) or in metal shell with diallyl phthalate or polyester insulators (both UL94V-0 rated)

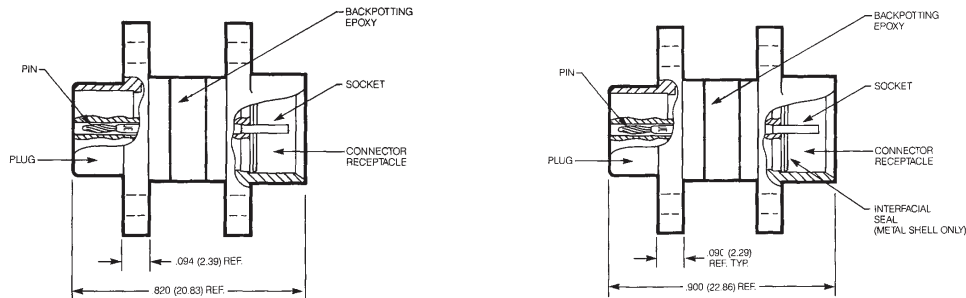

### Ordering Information

Number of Contacts	Metal Shell , Glass-Filled Polyester Part Number	All Plastic, Glass-Filled Polyester Part Number
9	DCDM9CS	DCDA9CS
15	DCDM15CS	DCDA15CS
21	DCDM21CS	DCDA21CS
25	DCDM25CS	DCDA25CS
31	DCDM31CS	DCDA31CS
37	DCDM37CS	DCDA37CS
51	DCDM51CS	DCDA51CS
100	DCDM100CS	--

Number of Positions	Glass-Filled Polyester Part Number	Mates to
9	DCDM9CS	DCCM9P*, DCCM9S*, DCDM9P*, DCDM9S*, M83513/01-A*, M83513/02-A*, M83513/03-A*, M83513/04-A*, M83513/10-A*, M83513/13-A*, M83513/16-A*, M83513/19-A*, M83513/22-A*, M83513/25-A*
15	DCDM15CS	DCCM15P*, DCCM15S*, DCDM15P*, DCDM15S*, M83513/01-B*, M83513/02-B*, M83513/03-B*, M83513/04-B*, M83513/10-B*, M83513/13-B*, M83513/16-B*, M83513/19-B*, M83513/22-B*, M83513/25-B*
21	DCDM21CS	DCCM21P*, DCCM21S*, DCDM21P*, DCDM21S*, M83513/01-C*, M83513/02-C*, M83513/03-C*, M83513/04-C*, M83513/10-C*, M83513/13-C*, M83513/16-C*, M83513/19-C*, M83513/22-C*, M83513/25-C*
25	DCDM25CS	DCCM25P*, DCCM25S*, DCDM25P*, DCDM25S*, M83513/01-D*, M83513/02-D*, M83513/03-D*, M83513/04-D*, M83513/10-D*, M83513/13-D*, M83513/16-D*, M83513/19-D*, M83513/22-D*, M83513/25-D*
31	DCDM31CS	DCCM31P*, DCCM31S*, DCDM31P*, DCDM31S*, M83513/01-E*, M83513/02-E*, M83513/03-E*, M83513/04-E*, M83513/10-E*, M83513/13-E*, M83513/16-E*, M83513/19-E*, M83513/22-E*, M83513/25-E*
37	DCDM37CS	DCCM37P*, DCCM37S*, DCDM37P*, DCDM37S*, M83513/01-F*, M83513/02-F*, M83513/03-F*, M83513/04-F*, M83513/10-F*, M83513/13-F*, M83513/16-F*, M83513/19-F*, M83513/22-F*, M83513/25-F*
51	DCDM51CS	DCCM51P*, DCCM51S*, DCDM51P*, DCDM51S*, M83513/01-G*, M83513/02-G*, M83513/03-G*, M83513/04-G*, M83513/11-G*, M83513/14-G*, M83513/17-G*, M83513/20-G*, M83513/23-G*, M83513/26-G*
100	DCDM100CS	DCCM100P*, DCCM100S*, DCDM100P*, DCDM100S*, M83513/01-H*, M83513/02-H*, M83513/03-H*, M83513/04-H*, M83513/12-H*, M83513/15-H*, M83513/18-H*, M83513/21-H*, M83513/24-H*, M83513/27-H*

## Micro-D Dust Covers



### Features

- Protects contacts before mating connector installed
- All plastic piece retains to mating face without additional hardware
- Color coded for plugs (blue) and sockets (red)
- Available for all Micro-D sizes 9, 15, 21, 25, 31, 37, 51 and 100

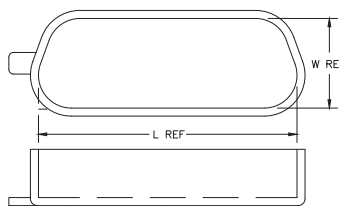

Dust covers are included with Micro-D connectors, but replacements are available for applications where the initial dust cover has been lost or damaged.

## Ordering Information

### Plug

Number of Contacts	Standard Part Number	Anti-Static Part Number	L Ref. in	W Ref. in
9	DCC9P	DCCAS9P	0.320	0.190
15	DCC15P	DCCAS15P	0.470	0.190
21	DCC21P	DCCAS21P	0.620	0.190
25	DCC25P	DCCAS25P	0.720	0.190
31	DCC31P	DCCAS31P	0.870	0.190
37	DCC37P	DCCAS37P	1.020	0.190
51	DCC51P	DCCAS51P	0.970	0.235
100	DCC100P	DCCAS100P	1.430	0.280

### Socket

Number of Contacts	Standard Part Number	Anti-Static Part Number	L Ref. in	W Ref. in
9	DCC9S	DCCAS9S	0.375	0.245
15	DCC15S	DCCAS15S	0.525	0.245
21	DCC21S	DCCAS21S	0.675	0.245
25	DCC25S	DCCAS25S	0.775	0.245
31	DCC31S	DCCAS31S	0.925	0.245
37	DCC37S	DCCAS37S	1.075	0.245
51	DCC51S	DCCAS51S	1.025	0.290
100	DCC100S	DCCAS100S	1.492	0.335

## Micro-D Sealing Gaskets

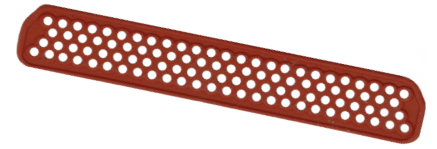

### Features

- Prevents moisture and dust from reaching contacts when connectors are mated
- Installed on the socket connectors only
- Comprised of compressible silicone rubber
- Available for all micro-d socket sizes 9, 15, 21, 25, 31, 37, 51 and 100

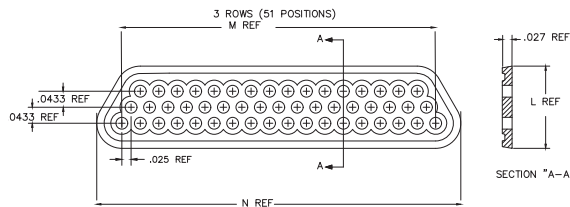

Sealing gaskets are included with Micro-D connectors, but replacements are available for applications where the initial gasket has been lost or damaged

### Ordering Information

Standard Part Number	Number of Contacts	L Ref. in	M Ref. in	N Ref. in
DCG9S	9	0.179	0.200	0.336
DCG15S	15	0.179	0.350	0.486
DCG21S	21	0.179	0.500	0.636
DCG25S	25	0.179	0.600	0.736
DCG31S	31	0.179	0.750	0.886
DCG37S	37	0.179	0.900	1.036
DCG51S	51	0.223	0.850	0.986
DCG100S	100	0.270	0.1250	1.386

## Mounting Hardware

### Jackscrews

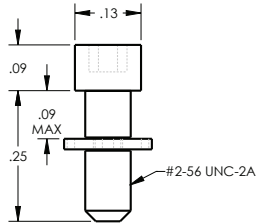
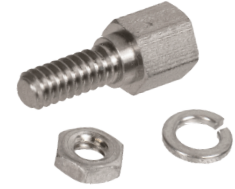

**#2/56**  
**DCJS9-51HLP**

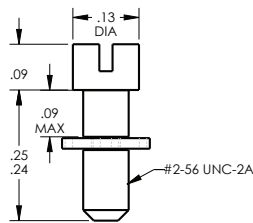

**#2/56**  
**DCJS9-51SLP**

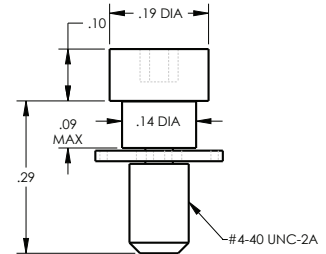

**#4/40**  
**DCJS100HLP**

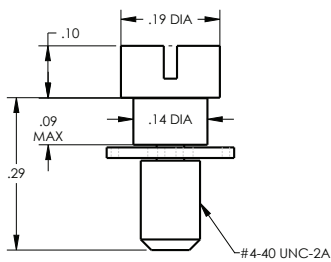

**#4/40**  
**DCJS100SLP**

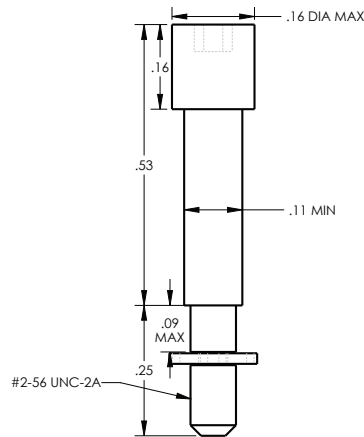

**#2/56**  
**DCJS9-51H**

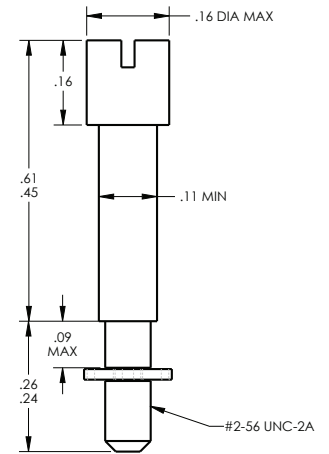

**#2/56**  
**DCJS9-51SLP**

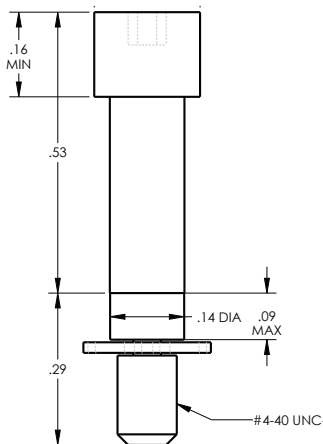

**#4/40**  
**DCJS100H**

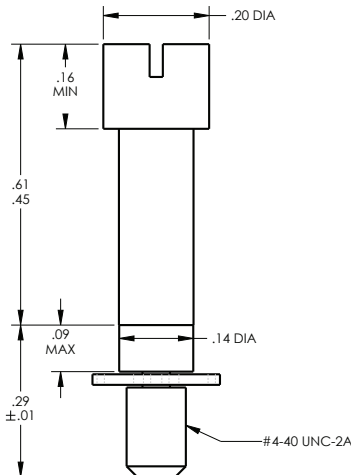

**#4/40**  
**DCJS100S**



# Dura-Con™ Micro-D Connectors

## Jackposts

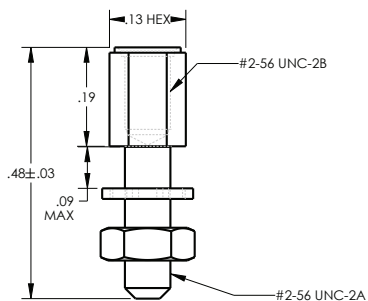

**#2/56, Front Mount**  
**DCJP9-51**

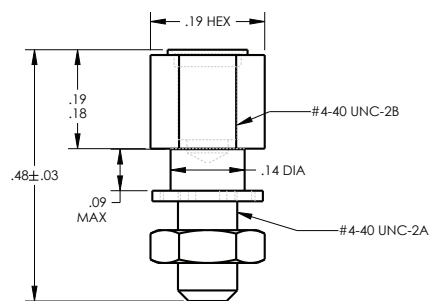

**#4/40, Front Mount**  
**DCJP100**

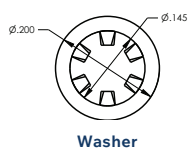

**Washer**

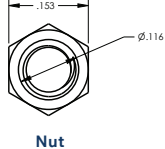

**Nut**



**#2/56 Thread, Rear Mount**  
**DCJPRM0xx** (See Table Below)

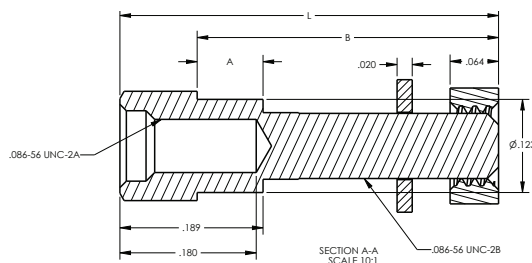

## Ordering Information

Part Number	Type	Style	Screwhead	Thread
DCJS9-51HLP	Jackscrew	Low Profile	Recessed Hex	#2/56
DCJS9-51H	Jackscrew	High Profile	Recessed Hex	#2/56
DCJS9-51SLP	Jackscrew	Low Profile	Slotted	#2/56
DCJS9-51S	Jackscrew	High Profile	Slotted	#2/56
DCJP9-51	Jackpost	Front Mount	Hex	#2/56
DCJPRM031	Jackpost	Rear Mount	Hex	#2/56
DCJPRM047	Jackpost	Rear Mount	Hex	#2/56
DCJPRM063	Jackpost	Rear Mount	Hex	#2/56
DCJPRM094	Jackpost	Rear Mount	Hex	#2/56
DCJS100HLP	Jackscrew	Low Profile	Recessed Hex	#4/40
DCJS100H	Jackscrew	High Profile	Recessed Hex	#4/40
DCJS100SLP	Jackscrew	Low Profile	Slotted	#4/40
DCJS100S	Jackscrew	High Profile	Slotted	#4/40
DCJP100	Jackpost	Front Mount	Hex	#4/40



## Micro-D EMI Backshells

### Features

- Multiple entry sizes
- Available for all Cinch Dura-Con Micro-D shells sizes: 9 to 100 pins
- Aluminum alloy shell available with electroless nickel plating
- Jackpost, socket head hardware and retaining clip included
- Crimpable ferrule sleeve included for bonding braided sleeve to wire entry
- Ferrule Crimp Tool M22520/5-01



### Ordering Information

**DCBS T 21C F N**

#### Cinch Dura-Con Series

DCBS = Micro D Backshell

#### Insulator type

T = Top Entry

#### Shell & Entry Size

<b>09A</b> = 9 Position, 0.160" Diameter	<b>31E</b> = 31 Position, 0.275" Diameter
<b>15B</b> = 15 Position, 0.190" Diameter	<b>37F</b> = 37 Position, 0.285" Diameter
<b>21C</b> = 21 Position, 0.220" Diameter	<b>51G</b> = 51 Position, 0.350" Diameter
<b>25D</b> = 25 Position, 0.260" Diameter	<b>100H</b> = 100 Position, 0.490" Diameter

#### Shell Finish

C = Yellow Chromate - Cadmium

N = Electroless Nickel

#### Wire Entry

Blank = Standard Designation

F = Crimp Ferrule

### Top Entry Backshell Dimensions

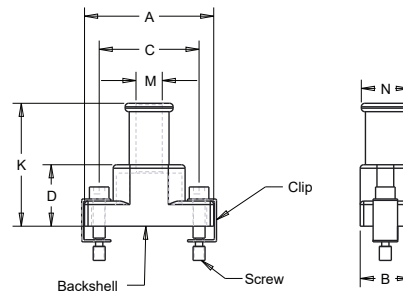

Shell Size	A Max. (in.)	Wire Entry Max. (in.)	Crimp Die M22520/5
9	0.752"	0.160" Dia.	-19
15	0.802"	0.190" Dia.	-41
21	0.852"	0.220" Dia.	-55
25	0.902"	0.260" Dia.	-47
31	0.942"	0.275" Dia.	-47
37	0.982"	0.285" Dia.	23
51	1.062"	0.350" Dia.	-21
100	1.127"	0.490" Dia.	None

## Micro-D Strain Relief Backshells

### Features

- Multiple entry sizes
- Available for all Cinch Dura-Con Micro-D shells sizes: 9 to 100 pins
- Aluminum alloy shell available with electroless nickel plating and cadmium plating
- Jackpost, socket head hardware and retaining clip included
- Wire entry extended for bonding braided sleeve to shell with a metal strap

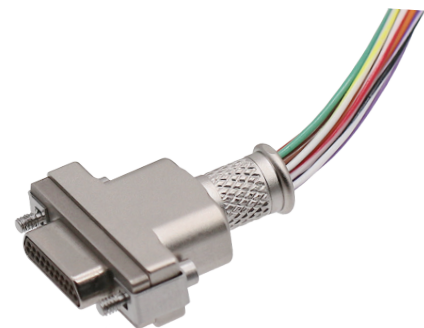

### Ordering Information

**DCBS T 21C N**

#### Cinch Dura-Con Series

DCBS = Micro D Backshell

#### Insulator Type

T = Top Entry

#### Shell & Entry Size

\*9A = 9 Position, A Size Entry

\*15B = 15 Position, B Size Entry

\*21C = 21 Position, C Size Entry

\*25D = 25 Position, D Size Entry

25H = 25 Position, H Size Entry

\*31E = 31 Position, E Size Entry

\*37E = 37 Position, E Size Entry

37F = 37 Position, F Size Entry

\*51F = 51 Position, F Size Entry

51H = 51 Position, H Size Entry

\*100H = 100 Position, H Size Entry

\*Indicates Cinch standard option

#### Shell Finish

C = Yellow Chromate - Cadmium

N = Electroless Nickel

### Top Entry Backshell Dimensions

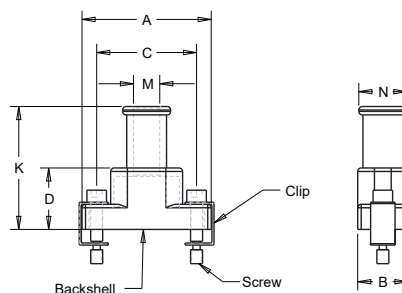

Shell Size	A Max. (in.)	B Max. (in.)	C Max. (in.)	D Max. (in.)	K Max. (in.)	M Max. (in.)	N Max. (in.)
9A	0.775	0.360	0.565	0.320	0.76	0.156	0.312
15B	0.925	0.360	0.715	0.440	0.88	0.188	0.344
21C	1.075	0.360	0.865	0.560	1.00	0.219	0.375
25D	1.175	0.360	0.965	0.620	1.06	0.250	0.406
25H	1.175	0.360	0.965	0.620	1.06	0.375	0.531
31E	1.325	0.360	1.115	0.680	1.12	0.281	0.437
37E	1.475	0.360	1.265	0.720	1.16	0.281	0.437
37F	1.475	0.360	1.265	0.720	1.16	0.312	0.469
51F	1.425	0.400	1.215	0.750	1.19	0.312	0.469
51H	1.425	0.400	1.215	0.750	1.19	0.375	0.531
100H	2.160	0.450	1.800	0.810	1.25	0.375	0.531

## MIL-DTL-83513 Metal Shell Connector

### Features

- All plastic and metal shell wire versions available in solder cup, gold-plated solid wire, and insulated stranded wire
- PCB mount “terminal block” type connectors available in straight or right angle
- Sizes offered - 9, 15, 21, 25, 31, 35, 51, and 100 (metal shell only)
- QPL (Qualified Product List) MIL-C-83513
- Optional shell platings and insulator materials offer high performance in harsh environments
- Mounting hardware per MIL-C-83513/05, see page 30 for options

### Ordering Information

**M83513/ 04-A 03 C**

Cinch Dura-Con M83513 Series

#### Connector Type

- 01 = Metal shell D plugs with solder cup termination
- 02 = Metal shell D sockets with solder cup termination
- 03 = Metal shell D plugs with wire leads
- 04 = Metal shell D sockets with wire leads

#### Insert arrangements

Blank = No. of contacts)

- A = 9
- B = 15
- C = 21
- D = 25
- E = 31
- F = 37
- G = 51
- H = 100

#### Shell Finish

- C = Yellow Chromate - Cadmium
- N = Electroless Nickel

#### Wire Entry

(Use only for /03 & /04, otherwise omit)

- 01 = M22759/11-26-9, 18 inches, white
- 02 = M22759/11-26-9, 36 inches, white
- 03 = M22759/11-26-( ), 18 inches, color coded
- 04 = M22759/11-26-( ), 36 inches, color coded
- 05 = QQ-W-343, 25 AWG, 0.5 inch, gold-plated
- 06 = QQ-W-343, 25 AWG, 1.0 inch, gold-plated
- 07 = QQ-W-343, 25 AWG, 0.5 inch, tin-plated
- 08 = QQ-W-343, 25 AWG, 1.0 inch, tin-plated
- 09 = M22759/33-26-9, 18 inches, white
- 10 = M22759/33-26-9, 36 inches, white
- 11 = M22759/33-26-( ), 18 inches, color coded
- 12 = M22759/33-26-( ), 36 inches, color coded
- 13 = M22759/11-26-9, 72 inches, white
- 14 = M22759/11-26-( ), 72 inches, color coded
- 15 = M22759/33-26-9, 72 inches, white
- 16 = M22759/33-26-( ), 72 inches, color coded

# Dura-Con™ MIL-DTL-83513 Connectors

## Connector Dimensions

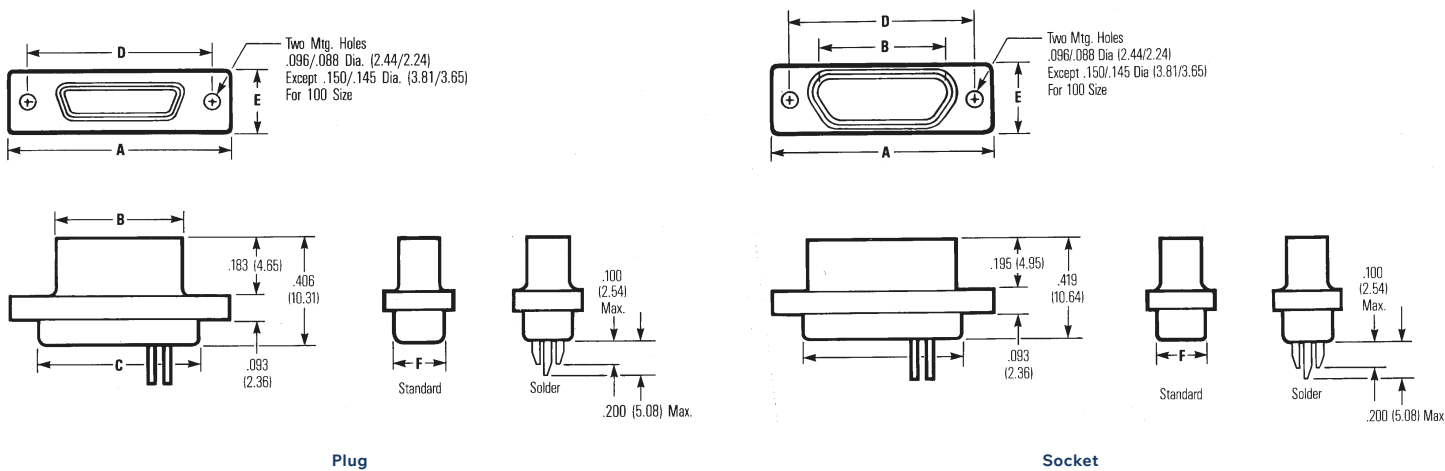

Number of Contacts	A		B		C		D		E		F	
	±0.010 (0.254)		Maximum (Plug) Minimum (Socket)		+0.010 (0.254) -0.018 (0.457)		±0.005 (0.127)		±0.010 (0.254)		Maximum	
	in	mm	in	mm	in	mm	in	mm	in	mm	in	mm
9 Plug	0.775	19.68	0.3338	8.48	0.390	9.91	0.565	14.35	0.298	7.57	0.270	6.68
9 Socket	0.775	19.68	0.3342	8.49	0.390	9.91	0.565	14.35	0.298	7.57	0.270	6.68
15 Plug	0.925	23.50	0.4838	12.29	0.540	13.72	0.715	18.16	0.298	7.57	0.270	6.68
15 Socket	0.925	23.50	0.4842	12.30	0.540	13.72	0.715	18.16	0.298	7.57	0.270	6.68
21 Plug	1.075	27.30	0.6338	16.10	0.690	17.53	0.865	21.97	0.298	7.57	0.270	6.68
21 Socket	1.075	27.30	0.6342	16.11	0.690	17.53	0.865	21.97	0.298	7.57	0.270	6.68
25 Plug	1.175	29.84	0.7338	18.64	0.790	20.07	0.965	24.51	0.298	7.57	0.270	6.68
25 Socket	1.175	29.84	0.7342	18.65	0.790	20.07	0.965	24.51	0.298	7.57	0.270	6.68
31 Plug	1.325	33.66	0.8838	22.45	0.940	23.88	1.115	28.32	0.298	7.57	0.270	6.68
31 Socket	1.325	33.66	0.8842	22.46	0.940	23.88	1.115	28.32	0.298	7.57	0.270	6.68
37 Plug	1.475	37.46	1.0338	26.26	1.090	27.69	1.265	32.13	0.298	7.57	0.270	6.68
37 Socket	1.475	37.46	1.0342	26.27	1.090	27.69	1.265	32.13	0.298	7.57	0.270	6.68
51 Plug	1.425	36.20	0.9838	24.99	1.040	26.42	1.215	30.86	0.341	8.66	0.310	7.87
51 Socket	1.425	36.20	0.9842	25.00	1.040	26.42	1.215	30.86	0.341	8.66	0.310	7.87
100 Plug	2.160	54.86	1.3838	35.15	1.432	36.38	1.800	45.71	0.384	9.75	0.360	9.15
100 Socket	2.160	54.86	1.3842	35.16	1.432	36.38	1.800	45.71	0.384	9.75	0.360	9.15

## MIL-DTL-83513 Plastic Shell Connectors

### Ordering Information

**M83513/ 06-A 04**

#### Cinch Dura-Con M83513 Series

#### Connector Type

- 06 = Plastic shell plugs with solder cup termination
- 07 = Plastic shell sockets with solder cup termination
- 08 = Plastic shell plugs with wire leads
- 09 = Plastic shell sockets with wire leads

#### Insert Arrangements

Blank = No. of contacts)

- A = 9
- B = 15
- C = 21
- D = 25
- E = 31
- F = 37
- G = 51

#### Wire Type

(Use only for /03 & /04, otherwise omit)

- 01 = M22759/11-26-9, 18 inches, white
- 02 = M22759/11-26-9, 36 inches, white
- 03 = M22759/11-26-( ), 18 inches, color coded
- 04 = M22759/11-26-( ), 36 inches, color coded
- 05 = QQ-W-343, 25 AWG, 0.5 inch, gold-plated
- 06 = QQ-W-343, 25 AWG, 1.0 inch, gold-plated
- 07 = QQ-W-343, 25 AWG, 0.5 inch, tin-plated
- 08 = QQ-W-343, 25 AWG, 1.0 inch, tin-plated
- 09 = M22759/33-26-9, 18 inches, white
- 10 = M22759/33-26-9, 36 inches, white
- 11 = M22759/33-26-( ), 18 inches, color coded
- 12 = M22759/33-26-( ), 36 inches, color coded
- 13 = M22759/11-26-9, 72 inches, white
- 14 = M22759/11-26-( ), 72 inches, color coded
- 15 = M22759/33-26-9, 72 inches, white
- 16 = M22759/33-26-( ), 72 inches, color coded

#### Note:

See page 33 for M83513 mounting hardware

# Dura-Con™ MIL-DTL-83513 Connectors

## Shell Dimensions - (All Plastic Version)

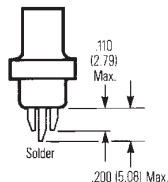
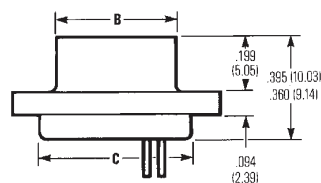
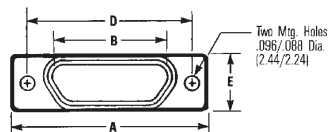
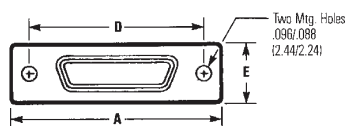

Plug

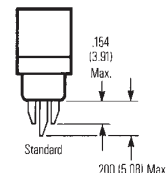
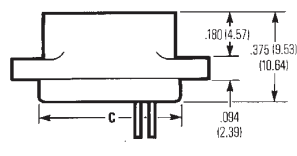

Socket

Number of Contacts	A +0.010 (0.254)		B Maximum (Plug) Minimum (Socket)		C +0.010 (0.254) -0.018 (0.457)		D ±0.005 (0.127)		E ±0.010 (0.254)		F Maximum	
	in	mm	in	mm	in	mm	in	mm	in	mm	in	mm
9 Plug	0.778	19.76	0.2918	7.41	0.398	10.11	0.565	14.35	0.208	5.28	0.173	4.39
9 Socket	0.778	19.76	0.2922	7.42	0.398	10.11	0.565	14.35	0.208	5.28	0.173	4.39
15 Plug	0.928	23.57	0.4418	11.22	0.548	13.92	0.715	18.16	0.208	5.28	0.173	4.39
15 Socket	0.928	23.57	0.4422	11.23	0.548	13.92	0.715	18.16	0.208	5.28	0.173	4.39
21 Plug	1.078	27.38	0.5918	15.03	0.698	17.73	0.865	21.97	0.208	5.28	0.173	4.39
21 Socket	1.078	27.38	0.5922	15.04	0.698	17.73	0.865	21.97	0.208	5.28	0.173	4.39
25 Plug	1.178	29.92	0.6918	17.57	0.798	20.27	0.965	24.51	0.208	5.28	0.173	4.39
25 Socket	1.178	29.92	0.6922	17.58	0.798	20.27	0.965	24.51	0.208	5.28	0.173	4.39
31 Plug	1.328	33.73	0.8418	21.38	0.948	24.08	1.115	28.32	0.208	5.28	0.173	4.39
31 Socket	1.328	33.73	0.8422	21.39	0.948	24.08	1.115	28.32	0.208	5.28	0.173	4.39
37 Plug	1.478	37.54	0.9918	25.19	1.098	27.89	1.265	32.13	0.208	5.28	0.173	4.39
37 Socket	1.478	37.54	0.9922	25.20	1.098	27.89	1.265	32.13	0.208	5.28	0.173	4.39
51 Plug	1.428	36.27	0.9418	23.92	1.048	26.62	1.215	30.86	0.250	6.35	0.220	5.59
51 Socket	1.428	36.27	0.9422	23.93	1.048	26.62	1.215	30.86	0.250	6.35	0.220	5.59

## MIL-DTL-83513 Metal Shell Connectors for PCBs

### Ordering Information

**M83513/ 10-C 02 C N**

Cinch Dura-Con M83513 Series

**Connector Type**

- 10 = Plug, 9-37 pos., narrow profile, rt. angle
- 11 = Plug, 51 pos., narrow profile, rt. angle
- 12 = Plug, 100 pos., narrow profile, rt. angle
- 13 = Socket, 9-37 pos., narrow profile, rt. angle
- 14 = Socket, 51 pos., narrow profile, rt. angle
- 15 = Socket, 100 pos., narrow profile, rt. angle
- 16 = Plug, 9-37 pos., std. profile, rt. angle
- 17 = Plug, 51 pos., std. profile, rt. angle
- 18 = Plug, 100 pos., std. profile, rt. angle
- 19 = Socket, 9-37 pos., std. profile, rt. angle
- 20 = Socket, 51 pos., std. profile, rt. angle
- 21 = Socket, 100 pos., std. profile, rt. angle
- 22 = Plug, 9-37 pos., straight mount
- 23 = Plug, 51 pos., straight mount
- 24 = Plug, 100 pos., straight mount
- 25 = Socket, 9-37 pos., straight mount
- 26 = Socket, 51 pos., straight mount
- 27 = Socket, 100 pos., straight mount

**Hardware**

- N = No jackpost
- P = Jackpost attached

**Shell Finish**

- C = Cadmium
- N = Electroless nickel

**Termination length**

- 01 = 0.109
- 02 = 0.140
- 03 = 0.172

**Insert arrangements**

- (No. of contacts)
- A = 9
  - B = 15
  - C = 21
  - D = 25
  - E = 31
  - F = 37
  - G = 51
  - H = 100



# Dura-Con™ MIL-DTL-83513 Connectors

## 90° Termination (/16-/21)

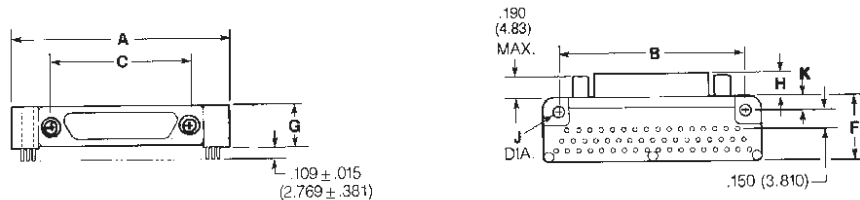

Number of Contacts	A		B		C		F		G		H		J		K	
	Maximum		±0.007 (0.18)		±0.005 (0.13)		Maximum		Maximum		Maximum		±0.005 (0.13)		±0.015 (0.38)	
	in	mm	in	mm	in	mm	in	mm	in	mm	in	mm	in	mm	in	mm
9 Plug	1.390	35.31	1.150	29.21	0.565	14.35	0.465	11.81	0.308	7.82	0.190	4.83	0.096	2.44	0.125	3.18
9 Socket	1.390	35.31	1.150	29.21	0.565	14.35	0.465	11.81	0.308	7.82	0.200	5.08	0.096	2.44	0.125	3.18
15 Plug	1.540	39.12	1.300	33.02	0.715	18.16	0.465	11.81	0.308	7.82	0.190	4.83	0.096	2.44	0.125	3.18
15 Socket	1.540	39.12	1.300	33.02	0.715	18.16	0.465	11.81	0.308	7.82	0.200	5.08	0.096	2.44	0.125	3.18
21 Plug	1.690	42.93	1.450	36.83	0.865	21.97	0.465	11.81	0.308	7.82	0.190	4.83	0.096	2.44	0.125	3.18
21 Socket	1.690	42.93	1.450	36.83	0.865	21.97	0.465	11.81	0.308	7.82	0.200	5.08	0.096	2.44	0.125	3.18
25 Plug	1.790	45.47	1.550	39.37	0.965	24.51	0.465	11.81	0.308	7.82	0.190	4.83	0.096	2.44	0.125	3.18
25 Socket	1.790	45.47	1.550	39.37	0.965	24.51	0.465	11.81	0.308	7.82	0.200	5.08	0.096	2.44	0.125	3.18
31 Plug	2.040	51.82	1.800	45.72	1.115	28.32	0.465	11.81	0.308	7.82	0.190	4.83	0.096	2.44	0.125	3.18
31 Socket	2.040	51.82	1.800	45.72	1.115	28.32	0.465	11.81	0.308	7.82	0.200	5.08	0.096	2.44	0.125	3.18
37 Plug	2.340	59.44	2.100	53.34	1.265	32.13	0.465	11.81	0.308	7.82	0.190	4.83	0.096	2.44	0.125	3.18
37 Socket	2.340	59.44	2.100	53.34	1.265	32.13	0.465	11.81	0.308	7.82	0.200	5.08	0.096	2.44	0.125	3.18
51 Plug	1.875	47.63	1.600	40.64	1.215	30.86	0.565	14.35	0.351	8.92	0.190	4.83	0.096	2.44	0.125	3.18
51 Socket	1.875	47.63	1.600	40.64	1.215	30.86	0.565	14.35	0.351	8.92	0.200	5.08	0.096	2.44	0.125	3.18
100 Plug	2.780	70.61	2.500	63.50	1.800	45.72	0.765	19.43	0.394	10.00	0.190	4.83	0.125	3.18	0.225	5.72
100 Socket	2.780	70.61	2.500	63.50	1.800	45.72	0.765	19.43	0.394	10.00	0.200	5.08	0.125	3.18	0.225	5.72

**NOTE:**

For additional connector dimensions, see Appendix D



## Straight (180°) Termination (/22-/27)

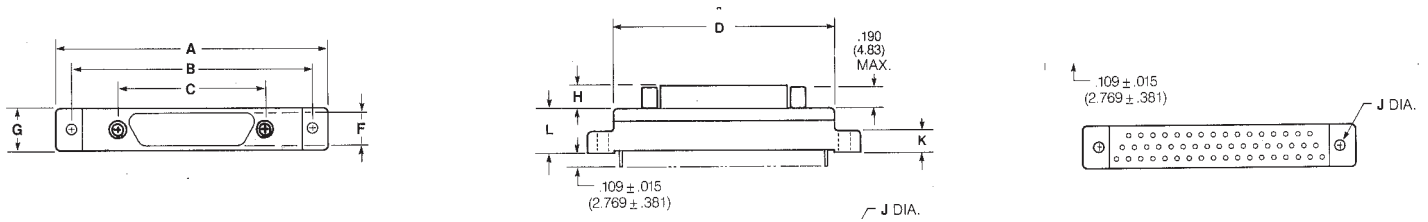

Number of Contacts	A		B		C		D		G		H		J		K		L	
	Maximum		±0.007 (0.18)		±0.005 (0.13)		Maximum		Maximum		Maximum		±0.005 (0.13)		Maximum		Maximum	
	in	mm	in	mm	in	mm	in	mm	in	mm	in	mm	in	mm	in	mm	in	mm
9 Plug	1.390	35.31	1.150	29.21	0.565	14.35	0.885	22.48	0.308	7.75	0.190	4.83	0.096	2.44	0.165	4.19	0.355	9.02
9 Socket	1.390	35.31	1.150	29.21	0.565	14.35	0.885	22.48	0.308	7.75	0.200	5.08	0.096	2.44	0.165	4.19	0.355	9.02
15 Plug	1.390	35.31	1.150	29.21	0.715	18.16	0.945	24.0	0.308	7.75	0.190	4.83	0.096	2.44	0.165	4.19	0.355	9.02
15 Socket	1.390	35.31	1.150	29.21	0.715	18.16	0.945	24.0	0.308	7.75	0.200	5.08	0.096	2.44	0.165	4.19	0.355	9.02
21 Plug	1.690	42.93	1.450	36.83	0.865	21.97	1.185	30.09	0.308	7.75	0.190	4.83	0.096	2.44	0.165	4.19	0.355	9.02
21 Socket	1.690	42.93	1.450	36.83	0.865	21.97	1.185	30.09	0.308	7.75	0.200	5.08	0.096	2.44	0.165	4.19	0.355	9.02
25 Plug	1.740	44.20	1.500	38.10	0.965	24.51	1.275	32.38	0.308	7.75	0.190	4.83	0.096	2.44	0.165	4.19	0.355	9.02
25 Socket	1.740	44.20	1.500	38.10	0.965	24.51	1.275	32.38	0.308	7.75	0.200	5.08	0.096	2.44	0.165	4.19	0.355	9.02
31 Plug	2.040	51.82	1.800	45.72	1.115	28.32	1.575	40.00	0.308	7.75	0.190	4.83	0.096	2.44	0.165	4.19	0.355	9.02
31 Socket	2.040	51.82	1.800	45.72	1.115	28.32	1.576	40.00	0.308	7.75	0.200	5.08	0.096	2.44	0.165	4.19	0.355	9.02
37 Plug	2.340	59.44	2.100	53.34	1.265	32.13	1.875	47.62	0.308	7.75	0.190	4.83	0.096	2.44	0.165	4.19	0.355	9.02
37 Socket	2.340	59.44	2.100	53.34	1.265	32.13	1.875	47.62	0.308	7.75	0.200	5.08	0.096	2.44	0.165	4.19	0.355	9.02
51 Plug	2.270	57.66	2.000	50.80	1.215	30.86	1.775	45.08	0.351	8.92	0.190	4.83	0.096	2.44	0.165	4.19	0.355	9.02
51 Socket	2.270	57.66	2.000	50.80	1.215	30.86	1.775	45.08	0.351	8.92	0.200	5.08	0.096	2.44	0.165	4.19	0.355	9.02
100 Plug	3.070	77.98	2.800	71.12	1.800	45.72	2.585	65.55	0.455	11.56	0.190	4.83	0.125	3.18	0.300	7.62	0.550	13.97
100 Socket	3.070	77.98	2.800	71.12	1.800	45.72	2.585	65.65	0.455	11.56	0.200	5.08	0.125	3.18	0.300	7.62	0.550	13.97

**NOTE:**

For additional connector dimensions, see Appendix D

# Dura-Con™ MIL-DTL-83513 Connectors

## 90° Narrow Termination (/10-/15)

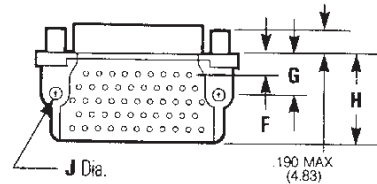
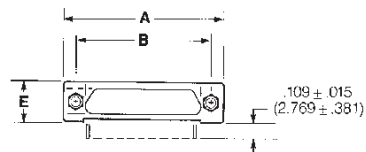

Number of Contacts	A		B		E		F		G		H		J	
	Maximum		±0.005 (0.13)		Maximum		±0.010 (0.25)		±0.010 (0.25)		Maximum		±0.005 (0.13)	
	in	mm	in	mm	in	mm	in	mm	in	mm	in	mm	in	mm
9 Plug	0.785	19.94	0.565	14.35	0.308	7.82	0.230	5.84	0.250	6.35	0.420	10.67	0.096	2.44
9 Socket	0.785	19.94	0.565	14.35	0.308	7.82	0.230	5.84	0.250	6.35	0.420	10.67	0.096	2.44
15 Plug	0.935	23.75	0.715	18.16	0.308	7.82	0.130	3.30	0.250	6.35	0.420	10.67	0.096	2.44
15 Socket	0.935	23.75	0.715	18.16	0.308	7.82	0.130	3.30	0.250	6.35	0.420	10.67	0.096	2.44
21 Plug	1.085	27.56	0.865	21.97	0.308	7.82	0.130	3.30	0.250	6.35	0.420	10.67	0.096	2.44
21 Socket	1.085	27.56	0.865	21.97	0.308	7.82	0.130	3.30	0.250	6.35	0.420	10.67	0.096	2.44
25 Plug	1.085	30.10	0.965	24.51	0.308	7.82	0.130	3.30	0.250	6.35	0.420	10.67	0.096	2.44
25 Socket	1.185	30.10	0.965	24.51	0.308	7.82	0.130	3.30	0.250	6.35	0.420	10.67	0.096	2.44
31 Plug	1.335	33.91	1.115	28.32	0.308	7.82	0.130	3.30	0.250	6.35	0.520	13.21	0.096	2.44
31 Socket	1.335	33.91	1.115	28.32	0.308	7.82	0.130	3.30	0.250	6.35	0.520	13.21	0.096	2.44
37 Plug	1.485	37.72	1.265	32.13	0.308	7.82	0.130	3.30	0.250	6.35	0.520	13.21	0.096	2.44
37 Socket	1.485	37.72	1.265	32.13	0.308	7.82	0.130	3.30	0.250	6.35	0.520	13.21	0.096	2.44
51 Plug	1.435	36.45	1.215	30.86	0.351	8.92	0.150	3.81	0.300	7.62	0.650	16.51	0.096	2.44
51 Socket	1.435	36.45	1.215	30.86	0.351	8.92	0.150	3.81	0.300	7.62	0.650	16.51	0.096	2.44
100 Plug	2.175	55.25	1.800	45.72	0.394	10.00	0.200	5.08	0.400	10.16	1.000	25.40	0.125	3.18
100 Socket	2.175	55.25	1.800	45.72	0.394	10.00	0.200	5.08	0.400	10.16	1.000	25.40	0.125	3.18

**NOTE:**

For additional connector dimensions, see Appendix D



## Mounting Hardware

### Jackscrows

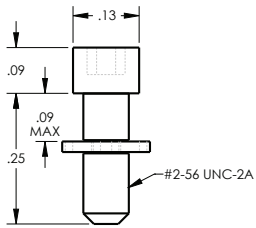

**#2/56**  
M83513/05-02

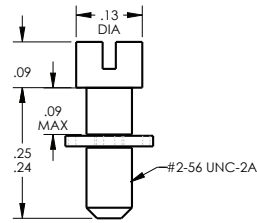

**#2/56**  
M83513/05-03

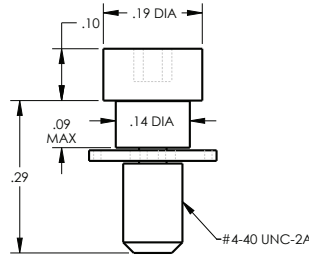

**#4/40**  
M83513/05-12

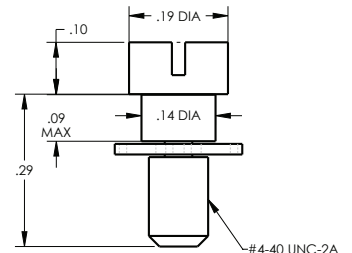

**#4/40**  
M83513/05-13

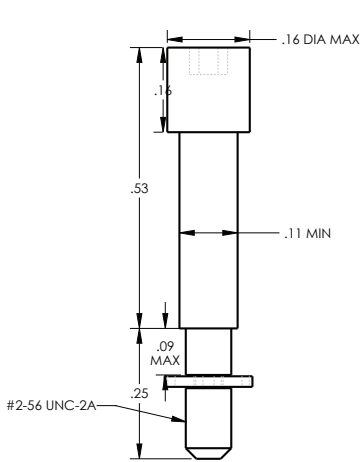

**#2/56**  
M83513/05-05

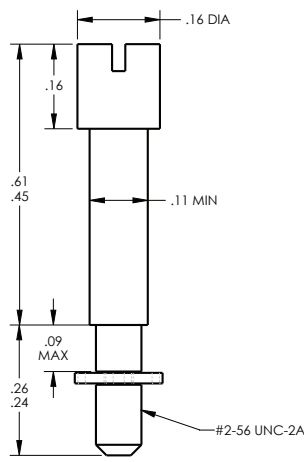

**#2/56**  
M83513/05-06

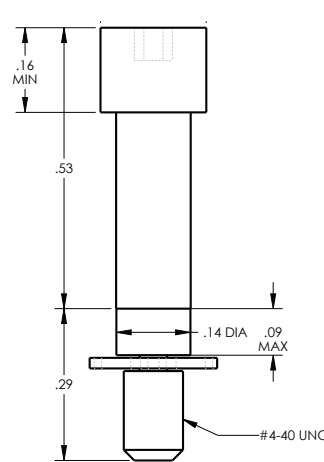

**#4/40**  
M83513/05-15

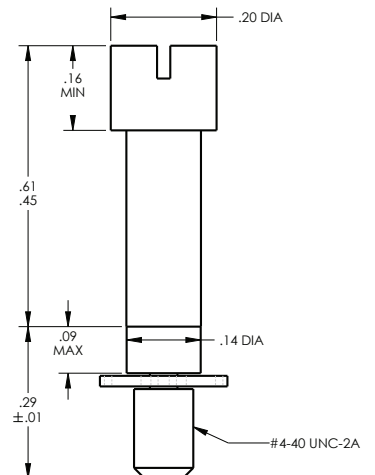

**#4/40**  
M83513/05-16

### Jackposts

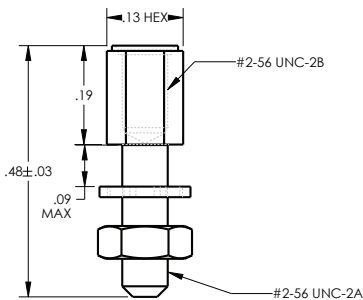

**#2/56**  
M83513/05-07

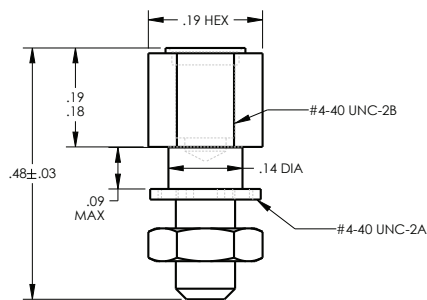

**#4/40**  
M83513/05-17

## Ordering Information

Type	Style	Screwhead	Thread	Military Part Number
Jackscrew	Low Profile	Recessed Hex	2/56	M83513/05-02
Jackscrew	High Profile	Recessed Hex	2/56	M83513/05-03
Jackscrew	Low Profile	Slotted	2/56	M83513/05-05
Jackscrew	High Profile	Slotted	2/56	M83513/05-06
Jackpost	--	--	2/56	M83513/05-07
Jackscrew	Low Profile	Hex	4/40*	M83513/05-12
Jackscrew	High Profile	Hex	4/40*	M83513/05-13
Jackscrew	Low Profile	Slotted	4/40*	M83513/05-15
Jackscrew	High Profile	Slotted	4/40*	M83513/05-16
Jackpost	--	--	4/40*	M83513/05-17

# Strip Connectors

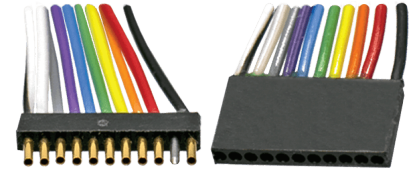

## Features

- Extremely lightweight
- Slim profile
- High-density interconnect
- High-reliability Dura-Con twist pin contact system for extreme shock and vibration applications
- Optional polarization with guide pins to prevent mismatching connectors
- Plug & socket available in sizes from 1 to 60 positions
- Economically priced

## Ordering Information

**CS A 1 - 10 P 5 C 4 - 00.5 G**

### Cinch Dura-Con Strip Series

CS = Thermoplastic glass-reinforced strip connector

### Contact Center

A = 0.050 (24 ga.)

### Contact Position

1 = Contacts in every position

### Number of Contact Positions

1 through 60\*

### Contact Type

P = Pin (plug)

S = Socket (receptacle)

### Wire Size in AWG

5 = 25 AWG solid copper wire

6 = 26 AWG stranded wire

S = Solder cup (skip to guide pin field if necessary)

### Guide Pin (Socket Only) Empty Cavity (Pin Only)

G02 = Guide pin position no. 2

GX = Special position, consult factory

### Lead Length in Inches

00.5 Solid copper wire only

01.0 Solid copper wire only

02.0 Solid copper wire only

18.0 Stranded wire only

24.0 Stranded wire only

36.0 Stranded wire only

48.0 Stranded wire only

### Insulation Color, Solid Wire Finish, Solid Cup finish

1 = All white

\*2 = All yellow

3 = Tin-plated

\*4 = Gold-plated (solid wire only)

\*5 = Color coded per mil-std. 681, system 1  
(stranded wire only)

### Insulation Wire or Solid Wire Type

C = Solid copper

E = MIL-W-168 78/4, 7 strand

\*Indicates Cinch standard option

\*\*Consult factory for larger sizes and multi-row

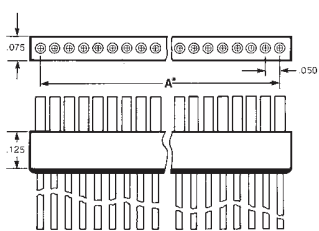

Socket Connector

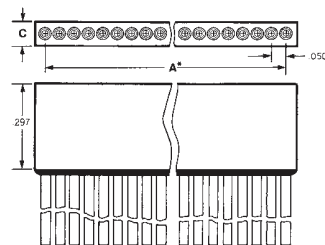
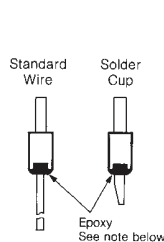

Pin Connector

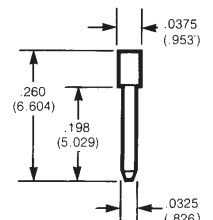
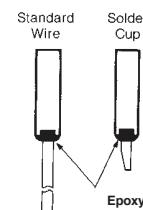

24 Gauge Stainless Steel Guide Pin\*

### NOTE:

\* Assembly in socket connector only.

Dimension A is number of positions less 1 multiplied by 0.050

## Appendix A - Material Specifications

### Dura-Con™ Micro-D Materials



#### Shell

<b>M - Metal</b>	Aluminum 6061, SAE AMS-QQ-A-250/11
<b>(Blank) - Cadmium Plating</b>	Cadmium with yellow chromate over coating, SAE-AMS-QQ-P-416, Type II, Class 3
<b>N - Nickel Plating</b>	Nickel, electroless, ASTM B733
<b>A - Plastic</b>	Polyester, 30% glass filled, black
<b>Plastic Body for PCB Mounted</b>	Polyphenylene sulfide, MIL-M-24519, Type GST-40F, black or LCP, black

#### Insulator

<b>C</b>	Diallyl phthalate glass reinforced, ASTM D-5948 Type SDG-F, green
<b>D</b>	Polyester, 30% glass filled, black

#### Contacts

<b>P - Pins</b>	Beryllium copper, gold pated, ASTM B 488 Type II Class 1.27
<b>S - Sockets</b>	Copper alloy C36000 or C34000, gold plated, ASTM B 488

#### Leads

<b>S - Solder Cups</b>	
<b>6 - Wires</b>	Copper alloy C36000 or C31400, gold plated, ASTM B 488
<b>E - Insulated</b>	Silver coated copper wire, extruded PTFE insulation, NEMA HP3, MIL-W-1678/4
<b>J - Insulated</b>	Silver coated high strength copper alloy wire, ETFE insulation, SAE AS 22759/33
<b>K - Insulated</b>	Silver coated copper wire, PTFE insulation, SAE AS 22759/11
<b>3 - Uninsulated</b>	Solid copper wire, gold plated, 60/40 PbSn solder dipped, A-A-59551
<b>4 - Uninsulated</b>	Solid copper wire, gold plated, A-A-59551
<b>PCB Tails</b>	
<b>(Blank) - SnPb Dipped</b>	Solid copper wire, gold plated, 60/40 PbSn solder dipped, A-A-59551
<b>2 - Gold Plated</b>	Solid copper wire, gold plated, A-A-59551

#### Other Components

<b>Encapsulant</b>	Epoxy
<b>Interfacial Seal (Sockets)</b>	Silicone rubber, ZZ-R-765, Class II B, Grade 70
<b>Dust Cover</b>	Low Density Polyethylene
<b>Hardware</b>	Passivated 300 series stainless steel, SAE AMS 2700

## Appendix B - Performance Specifications

### Dura-Con™ Performance Specifications

#### Environmental Specification

Salt Spray	No exposure of base metal when subject to 48 hours of EIA-364-26
Fluid Immersion	Mating / unmating performance is maintained after 20 hours of immersion in synthetic lubricating oil
Thermal Vacuum Outgassing	DCCM insulators and Nickel plated M83513 parts have a maximum TML of 1.0% and CVCM of 0.1%
Thermal Cycling	No damage after 5 cycles from -55°C to 125°C
Humidity	Dielectric performance drops to 100 VAC and insulation resistance to 1,000 megohms
Vibration	No damage after subject to 12 hours of 10 to 2,000 Hz with 20 g peak
Shock	No damage after subject to 50 g shock

#### Electrical Specification

Current Rating	3 Amps (max.)
Dielectric Withstanding Voltage	i. Sea Level: 600 VAC RMS ii. 70,000ft: 150 VAC RMS 60 Hz
Contact Resistance	8 milliohms maximum change
Insulation Resistance	5,000 megohms min between adjacent pins
Magnetic Permeability	Not to exceed 2.0 u

#### Mechanical Specification

Contact Engaging Force	6 ounce maximum per contact
Contact Separation Force	0.5 ounce minimum per contact
Contact Retention	Allowable voltage drop of 65 mV for SAE 22759/11, 75 mV for SAE 22759/33 and 60 mV for A-A-59551
Crimp Tensile Strength	5 lbs, 10 lbs for SAE 22759/33 wire
Solderability	Meets MIL-STD-202-208
Durability	No damage after subject to 500 mating cycles

#### Mating / Unmating Force

Number of Contacts	Mating Force Maximum		Unmating Force Minimum	
	lb	kg	lb	kg
9	5.63	2.56	0.28	0.13
15	9.38	4.26	0.47	0.21
21	13.13	5.96	0.66	0.30
25	15.63	7.10	0.78	0.35
31	19.38	8.80	0.97	0.44
37	23.13	10.50	1.16	0.53
51	31.88	14.47	1.59	0.72
100	62.50	28.38	3.13	1.42



## Appendix C - Contact Arrangements

### Plugs

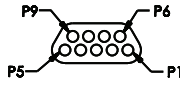

9 Contacts

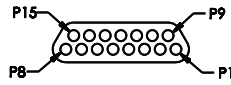

15 Contacts

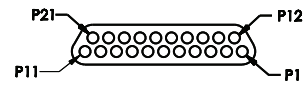

21 Contacts

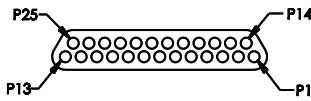

25 Contacts

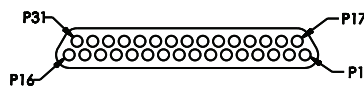

31 Contacts

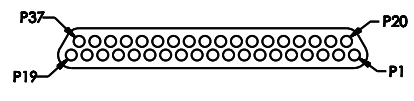

37 Contacts

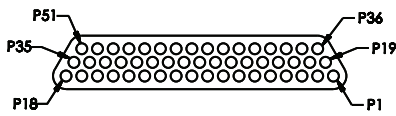

51 Contacts

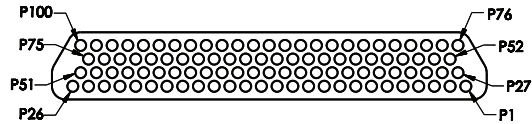

100 Contacts

### Sockets

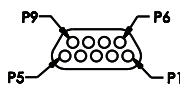

9 Contacts

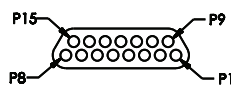

15 Contacts

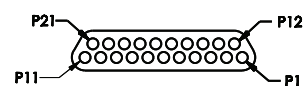

21 Contacts

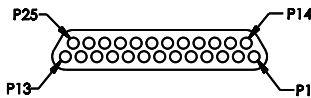

25 Contacts

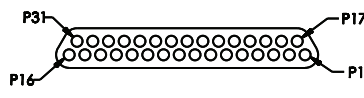

31 Contacts

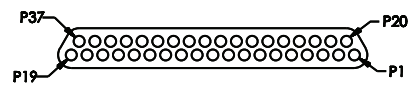

37 Contacts

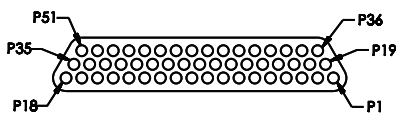

51 Contacts

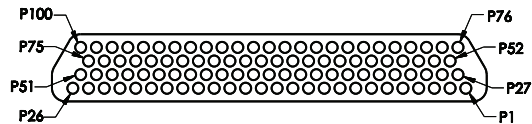

100 Contacts

## PCB Tails - 90° Narrow Termination

### Plugs

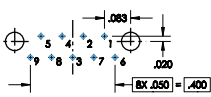
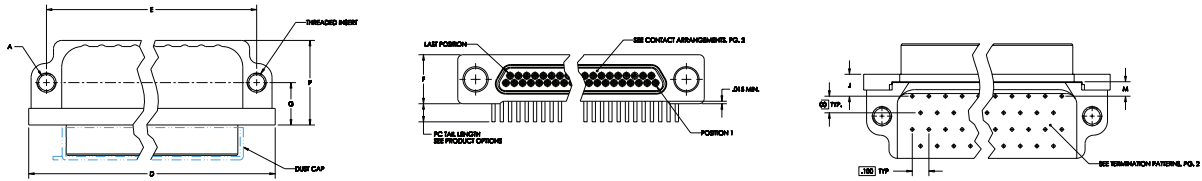

9 Position

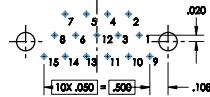

15 Position



21 Position

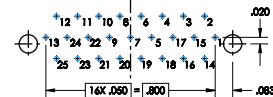

25 Position

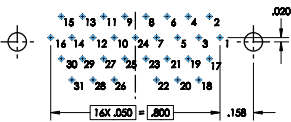

31 Position

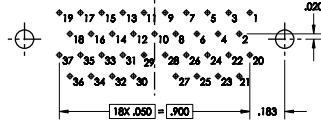

37 Position

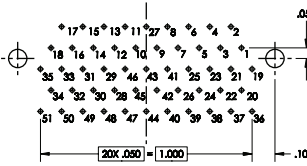

51 Position

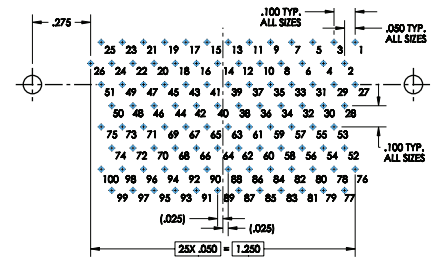

100 Position

### Sockets

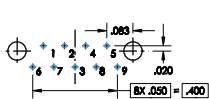
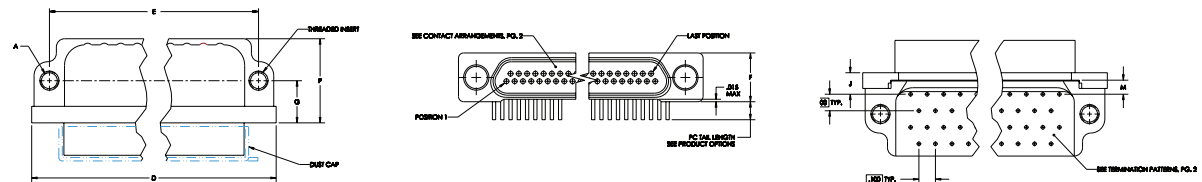

9 Position

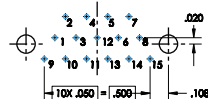

15 Position



21 Position



25 Position

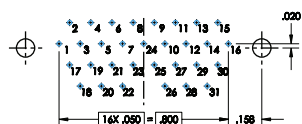

31 Position



37 Position

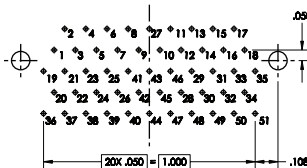

51 Position

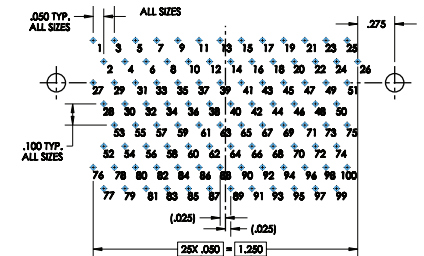

100 Position

NOTE:  
For the standard pinout arrangement, refer to page 40

## PCB Tails - 90° Standard Termination

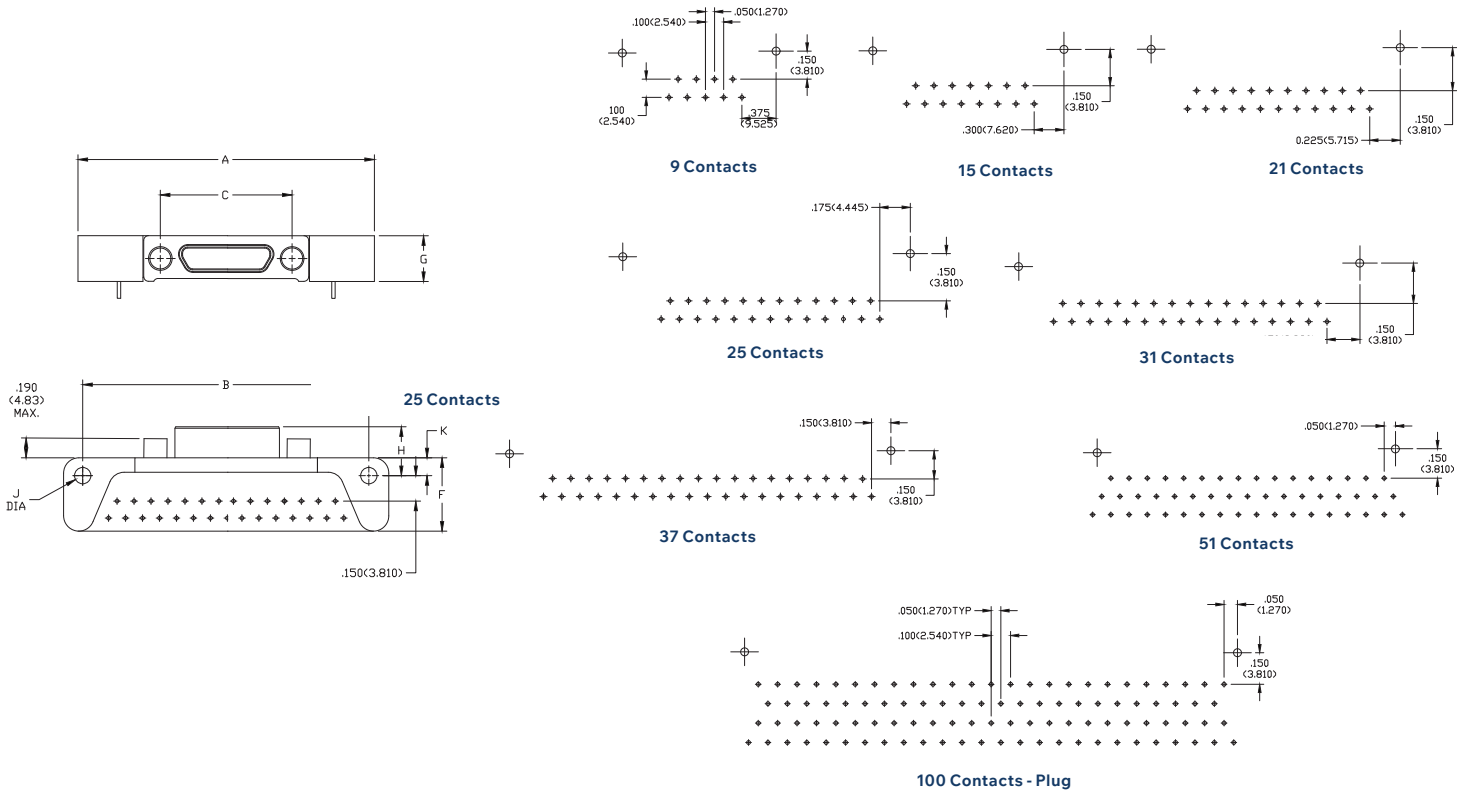

## PCB Tails - Straight Standard Termination

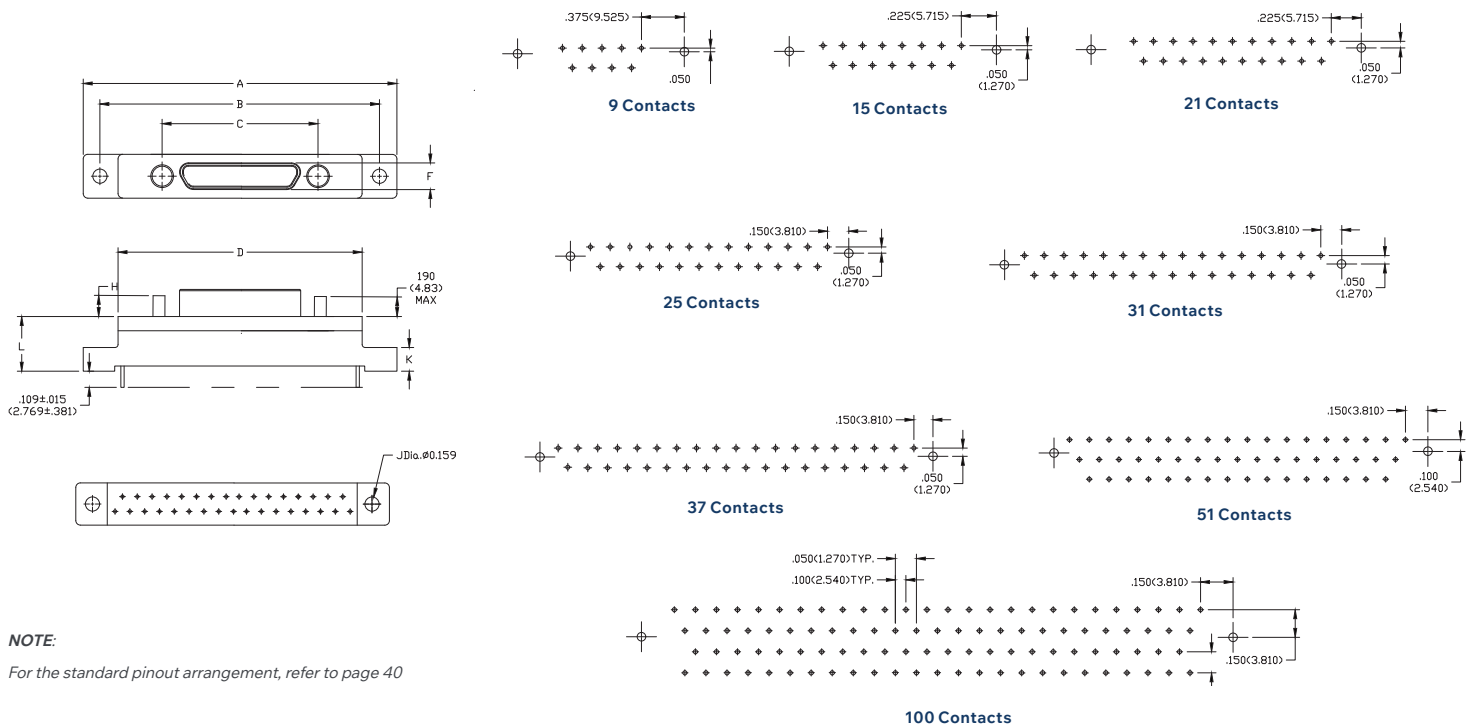

**NOTE:**  
For the standard pinout arrangement, refer to page 40

## Appendix D - Panel Cutouts

### Metal Shell Micro-D Connectors

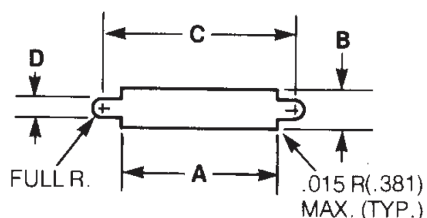

Figure 1: Front Mounting

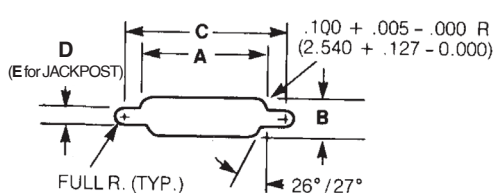

Figure 2: Rear Mounting

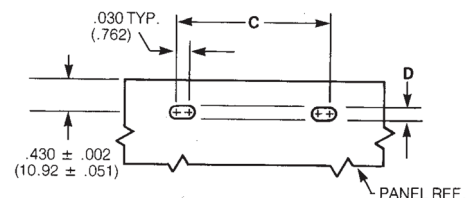

Figure 3: Edgeboard Mounting

Number of Contacts	Figure	A		B		C		D		E	
		+0.004 (0.101)		+0.004 (0.101)		+0.005 (0.127)		+0.005 (0.127)		+0.005 (0.127)	
		-0.000 (0.000)		-0.000 (0.000)		-0.000 (0.000)		-0.000 (0.000)		-0.000 (0.000)	
		in	mm	in	mm	in	mm	in	mm	in	mm
9	1	0.408	10.36	0.270	6.86	0.570	14.48	0.089	2.26	0.130	3.30
	2	0.408	10.36	0.256	6.50	0.570	14.48	0.089	2.26	0.130	3.30
	3	-	-	-	-	0.570	14.48	0.089	2.26	0.130	3.30
15	1	0.558	14.17	0.270	6.86	0.720	18.29	0.089	2.26	0.130	3.30
	2	0.558	14.17	0.256	6.50	0.720	18.29	0.089	2.26	0.130	3.30
	3	-	-	-	-	0.720	18.29	0.089	2.26	0.130	3.30
21	1	0.708	17.98	0.270	6.86	0.870	22.10	0.089	2.26	0.130	3.30
	2	0.708	17.98	0.256	6.50	0.870	22.10	0.089	2.26	0.130	3.30
	3	-	-	-	-	0.870	22.10	0.089	2.26	0.130	3.30
25	1	0.808	20.52	0.270	6.86	0.970	24.64	0.089	2.26	0.130	3.30
	2	0.808	20.52	0.256	6.50	0.970	24.64	0.089	2.26	0.130	3.30
	3	-	-	-	-	0.970	24.64	0.089	2.26	0.130	3.30
31	1	0.958	24.33	0.270	6.86	1.120	28.45	0.089	2.26	0.130	3.30
	2	0.958	24.33	0.256	6.50	1.120	28.45	0.089	2.26	0.130	3.30
	3	-	-	-	-	1.120	28.45	0.089	2.26	0.130	3.30
37	1	1.108	28.14	0.270	6.86	1.270	32.26	0.089	2.26	0.130	3.30
	2	1.108	28.14	0.256	6.50	1.270	32.26	0.089	2.26	0.130	3.30
	3	-	-	-	-	1.270	32.26	0.089	2.26	0.130	3.30
51	1	1.058	26.87	0.315	8.00	1.220	30.99	0.089	2.26	0.130	3.30
	2	1.058	26.87	0.300	7.62	1.220	30.99	0.089	2.26	0.130	3.30
	3	-	-	-	-	1.220	30.99	0.089	2.26	0.130	3.30
100	1	1.450	36.84	0.361	9.17	1.805	45.86	0.117	2.97	0.190	4.83
	2	1.562	39.68	0.338	8.58	1.805	45.86	0.117	2.97	0.190	4.83
	3	-	-	-	-	1.805	45.86	0.117	2.97	0.190	4.83

# Appendix

## Plastic Shell Micro-D Connectors

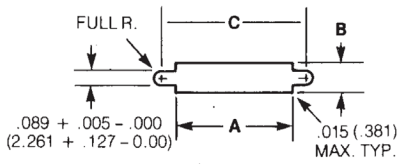

Figure 1: Front Mounting

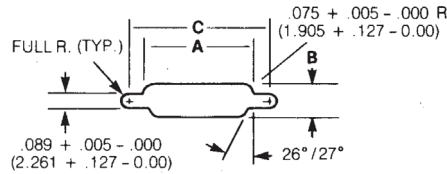

Figure 2: Rear Mounting

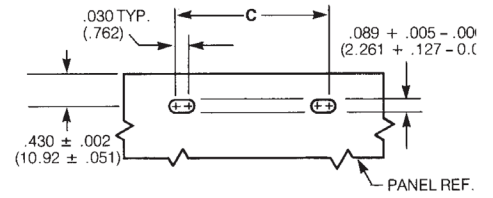
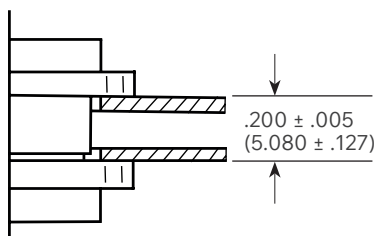

Figure 3: Edgeboard Mounting

Number of Contacts	Figure Number	A		B		C	
		+0.004 (0.101) -0.000 (0.000)		+0.004 (0.101) -0.000 (0.000)		+0.005 (0.127) -0.000 (0.000)	
		in	mm	in	mm	in	mm
9	1	0.408	10.36	0.172	4.37	0.570	14.48
	2	0.373	9.47	0.216	5.49	0.570	14.48
	3	-	-	-	-	0.570	14.48
15	1	0.558	14.17	0.172	4.37	0.720	18.29
	2	0.523	13.28	0.216	5.49	0.720	18.29
	3	-	-	-	-	0.720	18.29
21	1	0.708	17.98	0.172	4.37	0.870	22.10
	2	0.674	17.12	0.216	5.49	0.870	22.10
	3	-	-	-	-	0.870	22.10
25	1	0.808	20.52	0.172	4.37	0.970	24.64
	2	0.774	19.66	0.216	5.49	0.970	24.64
	3	-	-	-	-	0.970	24.64
31	1	0.958	24.33	0.172	4.37	1.120	28.45
	2	0.924	23.47	0.216	5.49	1.120	28.45
	3	-	-	-	-	1.120	28.45
37	1	1.108	28.14	0.172	4.37	1.270	32.26
	2	1.074	27.28	0.216	5.49	1.270	32.26
	3	-	-	-	-	1.270	32.26
51	1	1.058	26.87	0.215	5.46	1.220	30.99
	2	1.024	26.01	0.259	6.58	1.220	30.99
	3	-	-	-	-	1.220	30.99

## Panel Mounting Dimensions



Pin and Socket  
Rear Mounted

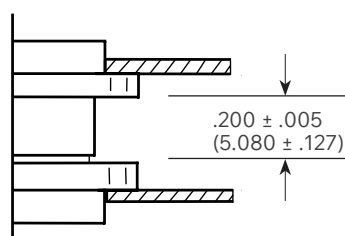

Pin and Socket  
Front Mounted

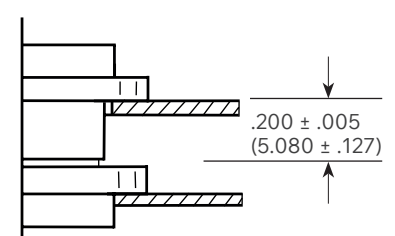

Pin Front Mounted  
Socket Rear Mounted

## Appendix E - Wire Information

### Wire Reference Table

Wire Code	C	E	J	K
Specification 0011003048	CDA-101	MIL-W-16878/4	SAE AS 22759-33	SAE AS 22759-11
Insulation	None	PTFE	Crosslinked ETFE	PTFE
Conductor	Copper	Silver Coated Copper	Silver Coated Copper	Silver Coated Copper
Operating Temperature	N/A	-85°F to +390°F	-85°F to +390°F	-85°F to +390°F
Voltage Rating	N/A	600V RMS	600V RMS	600V RMS
AWG	#25	#26	#26	#26
Stranding	1 x #25	7 x #34	19 x #38	19 x #38
Conductor Diameter (in.)	+/- .004"	0.019"	0.019"	0.019"
Insulated Wire Diameter (in.) +/- 0.002"	N/A	0.039"	0.032"	0.038"

### Factory Stocked Wire Types

#### Type C

Gauges: #25 AWG

Plating: 100 µin. tin "3", 30 µin. gold "4"

#### Type E

Gauges: #26 AWG

Colors: white "1", yellow "2", multi-color MIL-STD-681 "5", 10 color repeat MIL-STD-681 "7"

#### Type J

Gauges: #26 AWG

Colors: white "1", yellow "2", multi-color MIL-STD-681 "5", 10 color repeat MIL-STD-681 "7"

#### Type K

Gauges: #26 AWG

Colors: white "1", yellow "2", multi-color MIL-STD-681 "5", 10 color repeat MIL-STD-681 "7"

## MIL-STD-681 Wire Color Code Chart

PIN No.	MIL-STD-681 No.	Base Color	First Stripe	Second Stripe	PIN NO.	MIL-STD-681 No.	Base Color	First Stripe	Second Stripe	Third Stripe
1	0	BLK			51	957	WHT	GRN	VIO	
2	1	BRN			52	958	WHT	GRN	GRY	
3	2	RED			53	967	WHT	BLU	VIO	
4	3	ORN			54	968	WHT	BLU	GRY	
5	4	YEL			55	978	WHT	VIO	GRY	
6	5	GRN			56	9012	WHT	BLK	BRN	RED
7	6	BLU			57	9013	WHT	BLK	BRN	ORN
8	7	VIO			58	9014	WHT	BLK	BRN	YEL
9	8	GRY			59	9015	WHT	BLK	BRN	GRN
10	9	WHT			60	9016	WHT	BLK	BRN	BLU
11	90	WHT	BLK		61	9017	WHT	BLK	BRN	VIO
12	91	WHT	BRN		62	9018	WHT	BLK	BRN	GRY
13	92	WHT	RED		63	9023	WHT	BLK	RED	ORN
14	93	WHT	ORN		64	9024	WHT	BLK	RED	YEL
15	94	WHT	YEL		65	9025	WHT	BLK	RED	GRN
16	95	WHT	GRN		66	9026	WHT	BLK	RED	BLU
17	96	WHT	BLU		67	9027	WHT	BLK	RED	VIO
18	97	WHT	VIO		68	9028	WHT	BLK	RED	GRY
19	98	WHT	GRY		69	9034	WHT	BLK	ORN	YEL
20	901	WHT	BLK	BRN	70	9035	WHT	BLK	ORN	GRN
21	902	WHT	BLK	RED	71	9036	WHT	BLK	ORN	BLU
22	903	WHT	BLK	ORN	72	9037	WHT	BLK	ORN	VIO
23	904	WHT	BLK	YEL	73	9038	WHT	BLK	ORN	GRY
24	905	WHT	BLK	GRN	74	9045	WHT	BLK	YEL	GRN
25	906	WHT	BLK	BLU	75	9046	WHT	BLK	YEL	BLU
26	907	WHT	BLK	VIO	76	9047	WHT	BLK	YEL	VIO
27	908	WHT	BLK	GRY	77	9048	WHT	BLK	YEL	GRY
28	912	WHT	BRN	RED	78	9056	WHT	BLK	GRN	BLU
29	913	WHT	BRN	ORN	79	9057	WHT	BLK	GRN	VIO
30	914	WHT	BRN	YEL	80	9058	WHT	BLK	GRN	GRY
31	915	WHT	BRN	GRN	81	9067	WHT	BLK	BLU	VIO
32	916	WHT	BRN	BLU	82	9068	WHT	BLK	BLU	GRY
33	917	WHT	BRN	VIO	83	9078	WHT	BLK	VIO	GRY
34	918	WHT	BRN	GRY	84	9123	WHT	BRN	RED	ORN
35	923	WHT	RED	ORN	85	9124	WHT	BRN	RED	YEL
36	924	WHT	RED	YEL	86	9125	WHT	BRN	RED	GRN
37	925	WHT	RED	GRN	87	9126	WHT	BRN	RED	BLU
38	926	WHT	RED	BLU	88	9127	WHT	BRN	RED	VIO
39	927	WHT	RED	VIO	89	9128	WHT	BRN	RED	GRY
40	928	WHT	RED	GRY	90	9134	WHT	BRN	ORN	YEL
41	934	WHT	ORN	YEL	91	9135	WHT	BRN	ORN	GRN
42	935	WHT	ORN	GRN	92	9136	WHT	BRN	ORN	BLU

## MIL-STD-681 Wire Color Code Chart Continued

PIN No.	MIL-STD-681 No.	Base Color	First Stripe	Second Stripe	PIN NO.	MIL-STD-681 No.	Base Color	First Stripe	Second Stripe	Third Stripe
43	936	WHT	ORN	BLU	93	9137	WHT	BRN	ORN	VIO
44	937	WHT	ORN	VIO	94	9138	WHT	BRN	ORN	GRY
45	938	WHT	ORN	GRY	95	9145	WHT	BRN	YEL	GRN
46	945	WHT	YEL	GRN	96	9146	WHT	BRN	YEL	BLU
47	946	WHT	YEL	BLU	97	9147	WHT	BRN	YEL	VIO
48	947	WHT	YEL	VIO	98	9148	WHT	BRN	YEL	GRY
49	948	WHT	YEL	GRY	99	9156	WHT	BRN	GRN	BLU
50	956	WHT	GRN	BLU	100	9157	WHT	BRN	GRN	VIO

## Appendix F - Material Compliance

### RoHS Compliance

RoHS compliant parts include all plastic and nickel plated shells with solder cups and wire leads.

Parts are compliant with Exemption 6(c)

6(c) Copper alloy containing up to 4% lead by weight

Nickel plated shells with solder dipped PCB tails specify Exemption 7(b)

7(b) Lead in solders for servers, storage and storage array systems, network infrastructure equipment for switching, signaling, transmission, and network management for telecommunications.

Cadmium plated shells are not RoHS compliant

## Military to Commercial Part Number Cross Reference

### Solder Cup Plugs

Mil-Spec	Commercial
M83513/01-AC	DCDM9PSB
M83513/01-AN	DCCM9PSBN
M83513/01-BC	DCDM15PSB
M83513/01-BN	DCCM15PSBN
M83513/01-CC	DCDM21PSB
M83513/01-CN	DCCM21PSBN
M83513/01-DC	DCDM25PSB
M83513/01-DN	DCCM25PSBN
M83513/01-EC	DCDM31PSB
M83513/01-EN	DCCM31PSBN
M83513/01-FC	DCDM37PSB
M83513/01-FN	DCCM37PSBN
M83513/01-GC	DCDM51PSB
M83513/01-GN	DCCM51PSBN
M83513/01-HC	DCDM100PSB
M83513/01-HN	DCCM100PSBN

### Solder Cup Sockets

Mil-Spec	Commercial
M83513/02-AC	DCDM9SSB
M83513/02-AN	DCCM9SSBN
M83513/02-BC	DCDM15SSB
M83513/02-BN	DCCM15SSBN
M83513/02-CC	DCDM21SSB
M83513/02-CN	DCCM21SSBN
M83513/02-DC	DCDM25SSB
M83513/02-DN	DCCM25SSBN
M83513/02-EC	DCDM31SSB
M83513/02-EN	DCCM31SSBN
M83513/02-FC	DCDM37SSB
M83513/02-FN	DCCM37SSBN
M83513/02-GC	DCDM51SSB
M83513/02-GN	DCCM51SSBN
M83513/02-HC	DCDM100SSB
M83513/02-HN	DCCM100SSBN



## Military to Commercial Part Number Cross Reference Continued

### Wired Plugs

18" Insulated Wire Lead Plugs

Mil-Spec	Commercial
M83513/03-A03C	DCDM9P6K7-18.0B
M83513/03-A03N	DCCM9P6K7-18.0BN
M83513/03-B03C	DCDM15P6K7-18.0B
M83513/03-B03N	DCCM15P6K7-18.0BN
M83513/03-C03C	DCDM21P6K7-18.0B
M83513/03-C03N	DCCM21P6K7-18.0BN
M83513/03-D03C	DCDM25P6K7-18.0B
M83513/03-D03N	DCCM25P6K7-18.0BN
M83513/03-E03C	DCDM31P6K7-18.0B
M83513/03-E03N	DCCM31P6K7-18.0BN
M83513/03-F03C	DCDM37P6K7-18.0B
M83513/03-F03N	DCCM37P6K7-18.0BN
M83513/03-G03C	DCDM51P6K7-18.0B
M83513/03-G03N	DCCM51P6K7-18.0BN
M83513/03-H03C	DCDM100P6K7-18.0B
M83513/03-H03N	DCCM100P6K7-18.0BN

### Wired Plugs

18" Insulated Wire Lead Sockets

Mil-Spec	Commercial
M83513/04-A03C	DCDM9S6K7-18.0B
M83513/04-A03N	DCCM9S6K7-18.0BN
M83513/04-B03C	DCDM15S6K7-18.0B
M83513/04-B03N	DCCM15S6K7-18.0BN
M83513/04-C03C	DCDM21S6K7-18.0B
M83513/04-C03N	DCCM21S6K7-18.0BN
M83513/04-D03C	DCDM25S6K7-18.0B
M83513/04-D03N	DCCM25S6K7-18.0BN
M83513/04-E03C	DCDM31S6K7-18.0B
M83513/04-E03N	DCCM31S6K7-18.0BN
M83513/04-F03C	DCDM37S6K7-18.0B
M83513/04-F03N	DCCM37S6K7-18.0BN
M83513/04-G03C	DCDM51S6K7-18.0B
M83513/04-G03N	DCCM51S6K7-18.0BN
M83513/04-H03C	DCDM100S6K7-18.0B
M83513/04-H03N	DCCM100S6K7-18.0BN

### Narrow Right-Angle PCB Plugs

Mil-Spec	Commercial
M83513/10-A01CP	DCDM9PCBRP
M83513/10-A01NP	DCCM9PCBRPN
M83513/10-B01CP	DCDM15PCBRP
M83513/10-B01NP	DCCM15PCBRPN
M83513/10-C01CP	DCDM21PCBRP
M83513/10-C01NP	DCCM21PCBRPN
M83513/10-D01CP	DCDM25PCBRP
M83513/10-D01NP	DCCM25PCBRPN
M83513/10-E01CP	DCDM31PCBRP
M83513/10-E01NP	DCCM31PCBRPN
M83513/10-F01CP	DCDM37PCBRP
M83513/10-F01NP	DCCM37PCBRPN
M83513/10-G01CP	DCDM51PCBRP
M83513/10-G01NP	DCCM51PCBRPN
M83513/10-H01CP	DCDM100PCBRP
M83513/10-H01NP	DCCM100PCBRPN

### Narrow Right-Angle PCB Sockets

Mil-Spec	Commercial
M83513/13-A01CP	DCDM9SCBRP
M83513/13-A01NP	DCCM9SCBRPN
M83513/13-B01CP	DCDM15SCBRP
M83513/13-B01NP	DCCM15SCBRPN
M83513/13-C01CP	DCDM21SCBRP
M83513/13-C01NP	DCCM21SCBRPN
M83513/13-D01CP	DCDM25SCBRP
M83513/13-D01NP	DCCM25SCBRPN
M83513/13-E01CP	DCDM31SCBRP
M83513/13-E01NP	DCCM31SCBRPN
M83513/13-F01CP	DCDM37SCBRP
M83513/13-F01NP	DCCM37SCBRPN
M83513/13-G01CP	DCDM51SCBRP
M83513/13-G01NP	DCCM51SCBRPN
M83513/13-H01CP	DCDM100SCBRP
M83513/13-H01NP	DCCM100SCBRPN



## About Cinch Connectivity Solutions

In operation since 1917, Cinch supplies high quality, high performance connectors and cables globally to the Aerospace, Military/Defense, Commercial Transportation, Oil & Gas, High End Computer, and other markets. We provide custom solutions with our creative, hands on engineering and end to end approach.

Our diverse product offerings include: connectors, enclosures and cable assemblies utilizing multiple contact technologies including copper and fiber optics. Our product engineering and development activities employ cutting edge technologies for design and modeling, and our various technologies and expertise enable us to deliver custom solutions and products for our strategic partnerships.

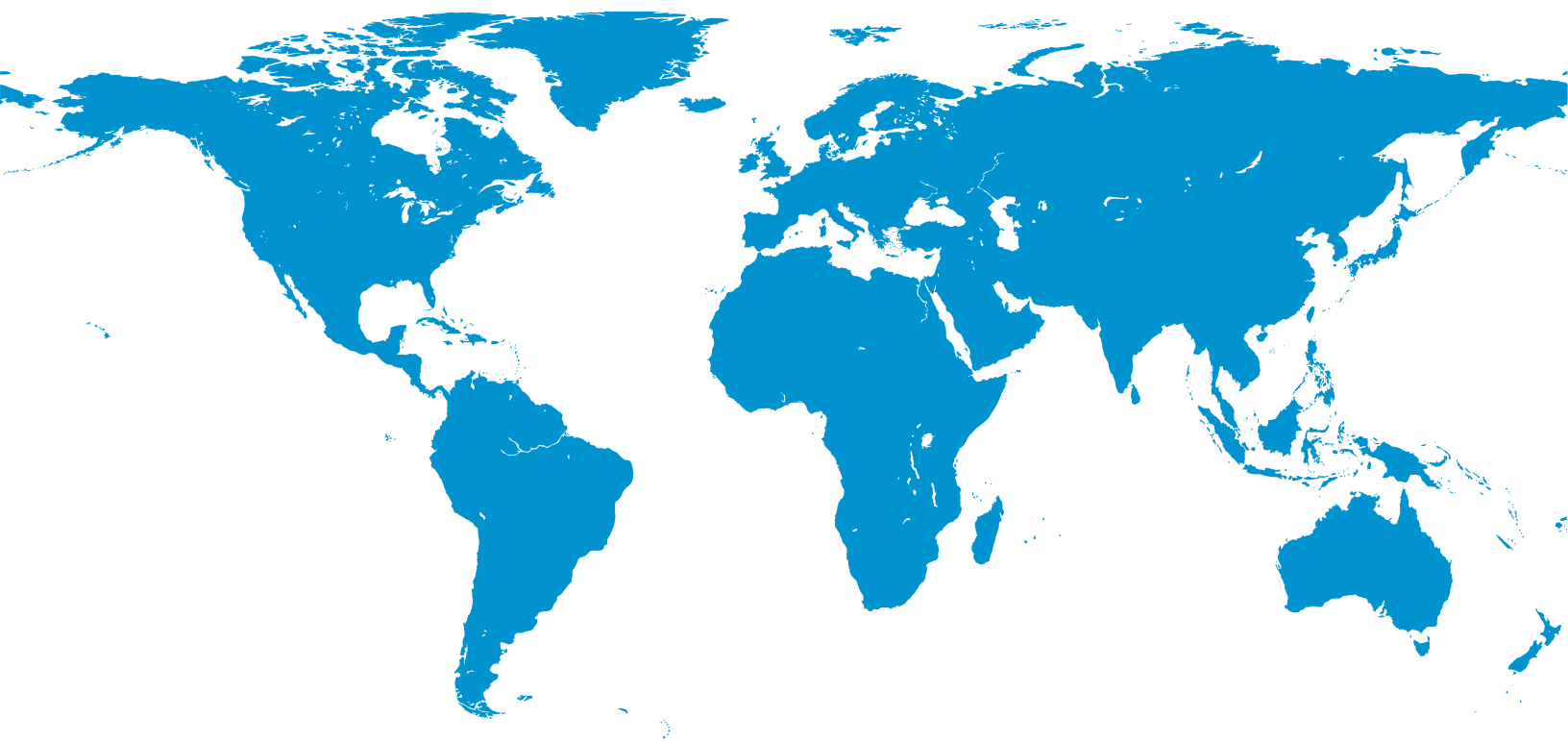

For more information, please contact us:

**North America**

+1 507.833.8822

[ccsorders@us.cinch.com](mailto:ccsorders@us.cinch.com)

**Asia-Pacific**

+86 21 5442 7668

[ccs.asia.sales@as.cinch.com](mailto:ccs.asia.sales@as.cinch.com)

**Europe, Middle East**

+44 (0) 1245 342060

[CinchConnectivity@eu.cinch.com](mailto:CinchConnectivity@eu.cinch.com)

[cinch.com](http://cinch.com)

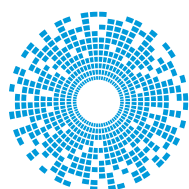

**cinch**  
CONNECTIVITY SOLUTIONS

a bel group