

2-1703498-1 ✓ ACTIVE

MCON | MCON 1.2mm

TE Internal #: 2-1703498-1

12 V, 2 Position, Automotive Housing for Male Terminals, Wire-to-Wire, 4 mm [.157 in] Centerline, Sealable, Gray, Wire & Cable, Power, MCON 1.2mm

[View on TE.com >](#)



Automotive Parts > Automotive Connectors > Automotive Housings > MCON 1.2, 1-row, 2-8 POS TAB Housing, Sealed



Nominal Voltage Architecture: 12 V

Connector & Housing Type: **Housing for Male Terminals**

Number of Positions: 2

Sealable: **Yes**

Operating Temperature Range: -40 – 125 °C [-40 – 257 °F]

[All MCON 1.2, 1-row, 2-8 POS TAB Housing, Sealed \(20\)](#)

Features

Product Type Features

Mixed & Hybrid Connector	No
Connector Shape	Rectangular
Connector & Housing Type	Housing for Male Terminals
Sealable	Yes
Primary Locking Feature	Locking Lance
Connector System	Wire-to-Wire
Connector & Contact Terminates To	Wire & Cable

Configuration Features

Number of Positions	2
Number of Rows	1

Electrical Characteristics

Operating Voltage	14 VDC
-------------------	--------



Nominal Voltage Architecture	12 V
------------------------------	------

Body Features

Cable Exit Angle	180 °
Primary Product Color	Gray
Connector & Keying Code	B

Contact Features

Contact Size	1.2mm
Contact Type	Tab
Mating Tab Width	1.2 mm[.047 in]
Contact Current Rating (Max)	25 A

Mechanical Attachment

Strain Relief	Without
Terminal Position Assurance	No
Mating Alignment Type	Keyed
Mating Alignment	With
Connector Mounting Type	Cable Mount (Free-Hanging)

Housing Features

Housing Material	PBT GF30
Centerline (Pitch)	4 mm[.157 in]

Dimensions

Product Width	44 mm[1.73 in]
Product Length	14.8 mm[.58 in]
Connector Height	14.95 mm[.58 in]

Usage Conditions

Operating Temperature Range	-40 – 125 °C[-40 – 257 °F]
Operating Temperature (Max)	125 °C[257 °F]

Operation/Application

Circuit Application	Power
---------------------	-------

Packaging Features

Packaging Quantity	1500
Packaging Method	Box & Carton

Other



Serviceable	Yes
Connector Position Assurance Capable	No

Product Compliance

[For compliance documentation, visit the product page on TE.com>](#)

EU RoHS Directive 2011/65/EU	Compliant
EU ELV Directive 2000/53/EC	Compliant
China RoHS 2 Directive MIIT Order No 32, 2016	有害物质含量符合标准要求 No Restricted Substance(s) Above Threshold
EU REACH Regulation (EC) No. 1907/2006	Current ECHA Candidate List: JUNE 2025 (250) Candidate List Declared Against: JUNE 2025 (250) Does not contain REACH SVHC
Halogen Content	BFR/CFR/PVC Free, but Br/Cl >900 ppm in other sources.
Solder Process Capability	Not applicable for solder process capability

Product Compliance Disclaimer

This information is provided based on reasonable inquiry of our suppliers and represents our current actual knowledge based on the information they provided. This information is subject to change. The part numbers that TE has identified as EU RoHS compliant have a maximum concentration of 0.1% by weight in homogenous materials for lead, hexavalent chromium, mercury, PBB, PBDE, DBP, BBP, DEHP, DIBP, and 0.01% for cadmium, or qualify for an exemption to these limits as defined in the Annexes of Directive 2011/65/EU (RoHS2). Finished electrical and electronic equipment products will be CE marked as required by Directive 2011/65/EU. Components may not be CE marked. Additionally, the part numbers that TE has identified as EU ELV compliant have a maximum concentration of 0.1% by weight in homogenous materials for lead, hexavalent chromium, and mercury, and 0.01% for cadmium, or qualify for an exemption to these limits as defined in the Annexes of Directive 2000/53/EC (ELV). Regarding the REACH Regulation, the information TE provides on SVHC in articles for this part number is based on the latest European Chemicals Agency (ECHA) 'Guidance on requirements for substances in articles' posted at this URL: <https://echa.europa.eu/guidance-documents/guidance-on-reach>

Compatible Parts



TE Part # 967067-2
MQS EINZELLEITDICHT



TE Part # 2-1670916-1
2POS, MCON 1.2 LL REC SEALED



TE Part # 3-1579028-8
EXTRACTION TOOL

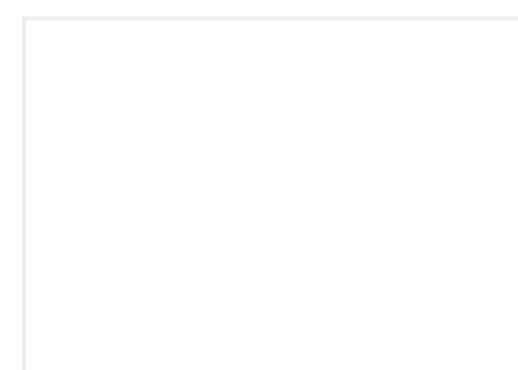

TE Part # 2-2378602-6
2POS,NEXTGEN, MCON 1.2 LL REC, SLD,COD B



TE Part # 2-2378602-2
2POS,NEXTGEN, MCON 1.2 LL REC,
SLD,COD B



TE Part # 2-2378602-1
2POS,NEXTGEN, MCON 1.2 LL REC,
SLD,COD B



TE Part # 2-1703499-1
2POS,TAB 1.2X0.6,TAB HSG,COD B



TE Part # CAT-N13-MSLRTT12
MCON 1.2 Locking Lance Receptacle
and Tab Terminals



TE Part # 1-1579028-5
INSERTION TOOL



TE Part # 967056-1
MQS BLINDSTOPFEN4MM

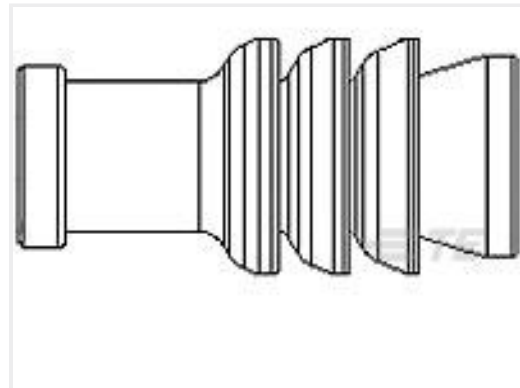

TE Part # 967067-1
MQS SGL WIRE SEAL



TE Part # 2-1718643-1
2POS, MCON 1.2 LL REC SEALED



TE Part # 2-1718643-4
2POS, MCON 1.2 LL REC SEALED

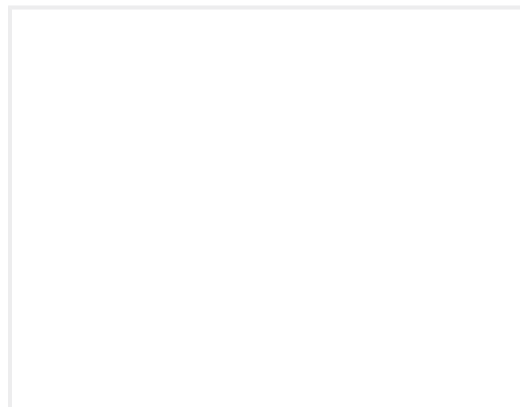

TE Part # 2-2441392-1
2POS,NEXTGEN, MCON 1.2 LL REC,
SLD,COD B

Also in the Series | **MCON 1.2mm**

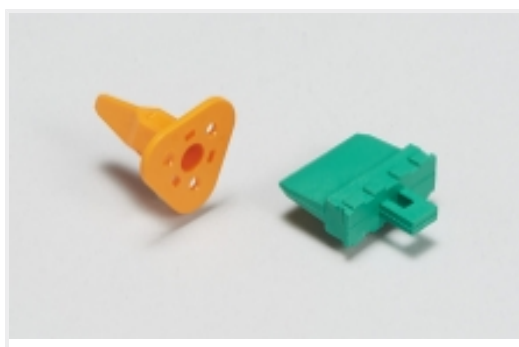

Automotive Connector Locks &
Position Assurance(9)

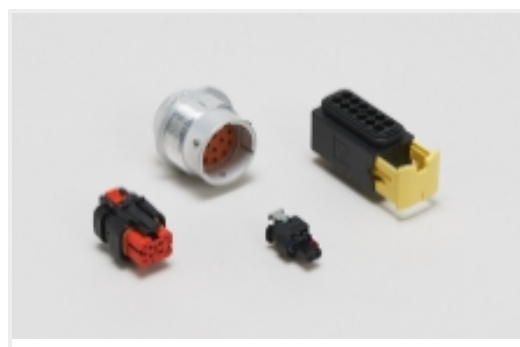

Automotive Housings(352)



Automotive Seals & Cavity Plugs(16)



Automotive Signal & Power Connector
Housings(348)

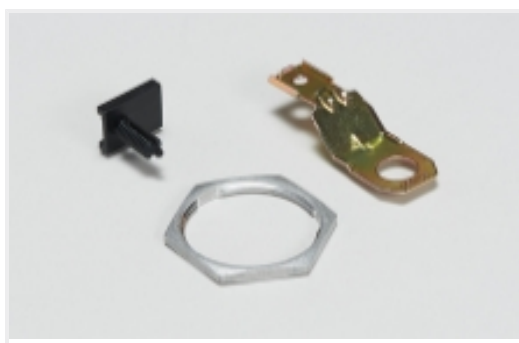

Other Automotive Connector
Accessories(12)

Customers Also Bought



Documents

Product Drawings

2POS, MCON 1.2 LL TAB SEALED COD B

English

CAD Files

3D PDF

3D

Customer View Model

[ENG_CVM_CVM_2-1703498-1_C.2d_dxf.zip](#)

English

Customer View Model

[ENG_CVM_CVM_2-1703498-1_C.3d_igs.zip](#)

English

Customer View Model

[ENG_CVM_CVM_2-1703498-1_C.3d_stp.zip](#)

English

By downloading the CAD file I accept and agree to the [Terms and Conditions](#) of use.

Product Specifications



Application Specification

English