

XDPL8219 40 W reference design with IPD80R900P7

For high-power-factor flyback converter with constant voltage output

About this document

Scope and purpose

This document is an engineering report for a reference design, REF-XDPL8219-U40W, which is based on Infineon's **XDPL8219** high-power-factor (HPF) flyback controller and **IPD80R900P7** MOSFET. This is a reference design for a 40 W front-stage HPF flyback converter with secondary-side regulated constant voltage output of 54 V, which can be used to supply a second-stage constant current converter for LED lighting applications.

Intended audience

Power supply design engineers and field application engineers.

Table of contents

About this document	1
Table of contents	1
1 Introduction and safety information	2
2 Design features	4
3 Board specifications	5
4 Schematic and PCB layout	7
5 Performance	10
5.1 Line and load regulation	10
5.2 Power efficiency	10
5.3 Standby power	11
5.4 Power factor and total harmonic distortion	11
5.5 Current harmonics	12
5.6 Input UV protection and brown-out power limitation.....	13
5.7 Regulated mode output UV protection and output power limitation under single fault condition..	13
5.8 UART reporting.....	14
5.8.1 Regular data reporting.....	14
5.8.2 Input voltage loss reporting.....	17
5.8.3 Error code reporting.....	18
5.9 Isolated UART reporting.....	19
5.10 Thermal test	19
6 BOM and transformer specifications	21
6.1 BOM.....	21
6.2 Transformer specifications	24
7 References	25
8 Revision history	26

1 Introduction and safety information

The **XDPL8219** 40 W reference design is a digitally configurable front-stage HPF flyback converter with secondary-side regulated (SSR) constant voltage (CV) output of 54 V. The CV output should not be used to directly drive the LEDs. For LED lighting applications, it should be converted to constant current (CC) output by a second-stage DC-DC switching or linear regulator.

The 40 W reference design sample is ready to be tested out of the box, with its main board already connected to a 54 V CV SSR plug-in board via connectors X200-A and X200-B, as shown in **Figure 1**. No pre-programming is needed, as it has already been burned with the first full configuration set of working parameters.

A simple test setup can be done by connecting the board's AC input (L – live, N – neutral) to the AC source, and the 54 V CV output (+, -) from connector X300-A to an electronic load in CC mode, based on **Figure 1**. Additionally, to capture and decode the UART reporting data packets, the connector X2 pin 2 (UART) can be connected to the oscilloscope via a voltage probe, with the grounding on the connector X2 pin 3 (PGND).

Attention: *Lethal voltages are present on this reference design. Do not operate the board unless you are trained to handle HV circuits. Do not leave this board unattended when it is powered up.*

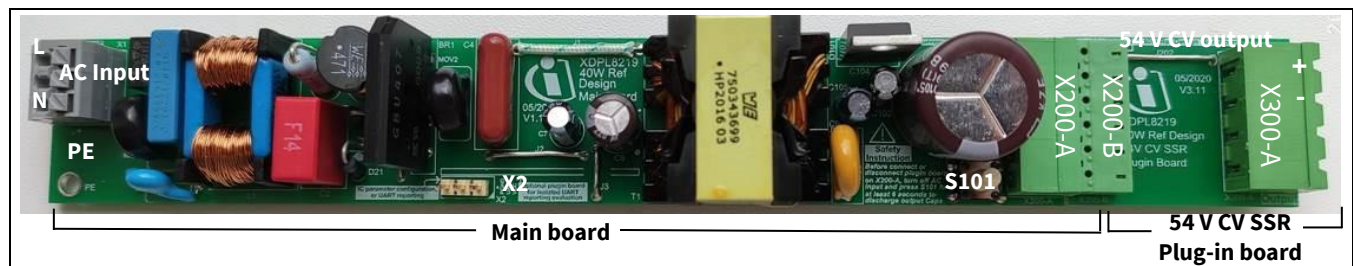

Figure 1 XDPL8219 40 W reference design main board and 54 V CV SSR plug-in board

If the 54 V CV SSR plug-in board is not connected to the reference design main board, the flyback output voltage of the main board will become unregulated with either the V_{CC} or output overvoltage (OV) protection of **XDPL8219** being triggered.

An isolated UART reporting evaluation plug-in board (see **Figure 2**) is included in the **XDPL8219** 40 W reference design packaging box. This plug-in board has an isolated optocoupler-based circuit, which can be evaluated optionally, by connecting it to the **XDPL8219** 40 W reference design main board. The recommended evaluation setup and procedures are written at the bottom layer of this plug-in board (see **Figure 9**).

Attention: For safety purposes, before disconnecting or connecting any plug-in board, the connected AC source or DC source must be switched off and followed by the output voltage discharge. A tactile switch S101 provides an option to discharge the flyback secondary output voltage, by pressing and holding it until the output voltages are at safe levels based on measurement. When disconnecting or connecting a plug-in board, the user should only hold onto either the main board connector X200-A or the PCB edges just next to this connector.

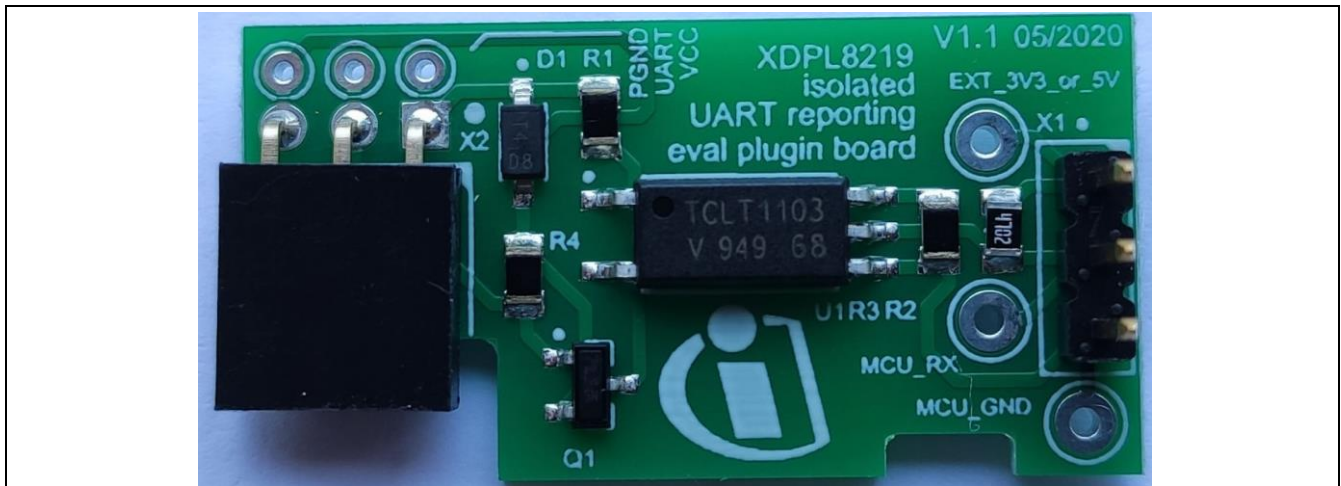

Figure 2 XDPL8219 isolated UART reporting evaluation plug-in board

2 Design features

- Secondary-side regulated (SSR) constant voltage (CV) output
- Supports universal input with 90 V_{rms} to 305 V_{rms} and DC input with 127 V to 432 V
- High-power-factor (HPF) and low total harmonic distortion (iTHD), across wide AC input voltage range (120 V_{rms} to 277 V_{rms}) and wide output load range (33 percent to 100 percent of full load)
- High efficiency with quasi-resonant (QR) mode, switching in valley n (QRMn), across wide input and output load range
- No-load standby power, as low as less than 100 mW with active burst mode (ABM)
- Input overvoltage protection (OVP) and input undervoltage protection (UVP)
- Power limitation during brown-out, to better protect primary components, e.g., the flyback MOSFET, from overheating and magnetics from saturation
- Output power limitation and output UVP, under single fault condition where the second-stage constant current DC-DC converter MOSFET drain pin is shorted to the source pin
- Output and V_{CC} OVP, under feedback open condition
- Output short protection
- V_{CC} UVP
- Configurable parameters, e.g., brown-out power limitation slope, protection thresholds and reaction (auto restart/latch)
- Reporting of system information, e.g., input voltage, line frequency, controller temperature, input voltage loss, and error code of last triggered protection, via unidirectional UART communication

Board specifications

3 Board specifications

Table 1 and **Table 2** respectively list the electrical specifications and system protection parameter values of the reference design.

Table 1 Electrical specifications

Specification	Symbol	Value	Unit
Normal operational AC input voltage	V AC	90 ~ 305	V _{rms}
Normal operational AC input frequency	F _{line}	47 ~ 63	Hz
Normal operational DC input voltage	V DC	127 ~ 300	V
SSR CV output set-point	V _{out,setpoint}	54	V
Steady-state output load current	I _{out}	0 ~ 800	mA
Steady-state full-load output power	P _{out,full}	43.2	W
Total line, load regulation of V _{out}	ΔV _{out}	± 1	%
Power efficiency 1 (V AC = 230 V _{rms} ; I _{out} = 600 mA to 800 mA)	η ₁	More than 92	%
Power efficiency 2 (V AC = 230 V _{rms} ; I _{out} = 400 mA to 600 mA)	η ₂	More than 91	%
Power efficiency 3 (V AC = 120 V _{rms} to 277 V _{rms} ; I _{out} = 400 mA to 800 mA)	η ₃	More than 91	%
Power efficiency 4 (V AC = 120 V _{rms} to 277 V _{rms} ; I _{out} = 265 mA to 400 mA)	η ₄	More than 90	%
Power factor 1 (V AC = 230 V _{rms} ; F _{line} = 50 Hz; I _{out} = 400 mA to 800 mA)	PF ₁	More than 0.98	–
Power factor 2 (V AC = 230 V _{rms} ; F _{line} = 50 Hz; I _{out} = 265 mA to 400 mA)	PF ₂	More than 0.96	–
Power factor 3 (V AC = 120 V _{rms} and 277 V _{rms} ; F _{line} = 60 Hz; I _{out} = 400 to 800 mA)	PF ₃	More than 0.96	–
Power factor 4 (V AC = 120 V _{rms} and 277 V _{rms} ; F _{line} = 60 Hz; I _{out} = 265 to 400 mA)	PF ₄	More than 0.9	–
Total harmonic distortion 1 (V AC = 230 V _{rms} ; F _{line} = 50 Hz; I _{out} = 265 to 800 mA)	iTHD ₁	Less than 10	%
Total harmonic distortion 2 (V AC = 120 V _{rms} and 277 V _{rms} ; F _{line} = 60 Hz; I _{out} = 400 to 800 mA)	iTHD ₂	Less than 10	%
Total harmonic distortion 3 (V AC = 120 V _{rms} and 277 V _{rms} ; F _{line} = 60 Hz; I _{out} = 265 to 400 mA)	iTHD ₃	Less than 15	%

Board specifications

Table 2 System protection parameter values

System protection parameter	Symbol	Value	Unit
Input OVP level ¹	V_{inOV}	350	V_{rms}
Maximum input voltage level for start-up ¹	$V_{in,start,max}$	326	V_{rms}
Brown-in/Minimum input voltage level for start-up ¹	$V_{in,start,min}$	82	V_{rms}
Brown-out/Input UVP level ¹	V_{inUV}	70	V_{rms}
Output OVP level ¹	V_{outOV}	65	V
Start-up output UVP (short) level ¹	$V_{out,start}$	31	V
Regulated mode output UVP level ¹	V_{outUV}	33	V
Regulated mode output UVP blanking time ¹	$t_{voutUV,blank}$	500	ms
V_{CC} OVP level ¹	$V_{VCC,max}$	23	V
Regulated mode V_{CC} UVP level ¹	$V_{VCC,min}$	7.5	V
Regulated mode CS pin maximum voltage at the lowest operational input voltage ¹	$V_{OCP1,at,V,in,low}$	0.52	V
Lowest operational input voltage ¹	$V_{in,low}$	82	V_{rms}
Regulated mode CS pin maximum voltage at the highest operational input voltage ¹	$V_{OCP1,at,V,in,high}$	0.43	V
Highest operational input voltage ¹	$V_{in,high}$	326	V_{rms}
IC overtemperature protection level ²	$T_{critical}$	119	°C
Maximum IC temperature for start-up	$T_{start,max}$	$T_{critical} - 4 = 115$	°C
Input OVP reaction	$Reaction_{OVP,Vin}$	Auto restart	–
Input UVP reaction	$Reaction_{UVP,Vin}$	Auto restart	–
Output OVP reaction ¹	$Reaction_{OVP,Vout}$	Auto restart	–
Start-up output UVP reaction	$Reaction_{UVP,Vout,start}$	Auto restart	–
Regulated mode output UVP reaction ¹	$Reaction_{UVP,Vout}$	Auto restart	–
V_{CC} OVP reaction ¹	$Reaction_{VCC,OVP}$	Latch mode	–
Regulated mode V_{CC} UVP reaction	$Reaction_{VCC,UVP}$	Auto restart	–
IC overtemperature protection reaction	$Reaction_{TP}$	Auto restart	–
Auto restart time ¹	$t_{auto,restart}$	1.2	s

Note: The input and output sensing voltages for these protections are estimated from ZCD pin switching signals. To improve the input voltage estimation accuracy, CS pin switching signal is also sensed.

Note: Regulated mode is a controller operating state, which is entered after the start-up phase, to regulate the output based on the feedback voltage signal.

¹ Configurable

² Configurable up to 143°C (lifetime is not guaranteed when IC operating junction temperature is above 125°C)

4 Schematic and PCB layout

Figure 3 and Figure 4 respectively show the main board schematic and 54 V CV SSR plug-in board schematic of this reference design.

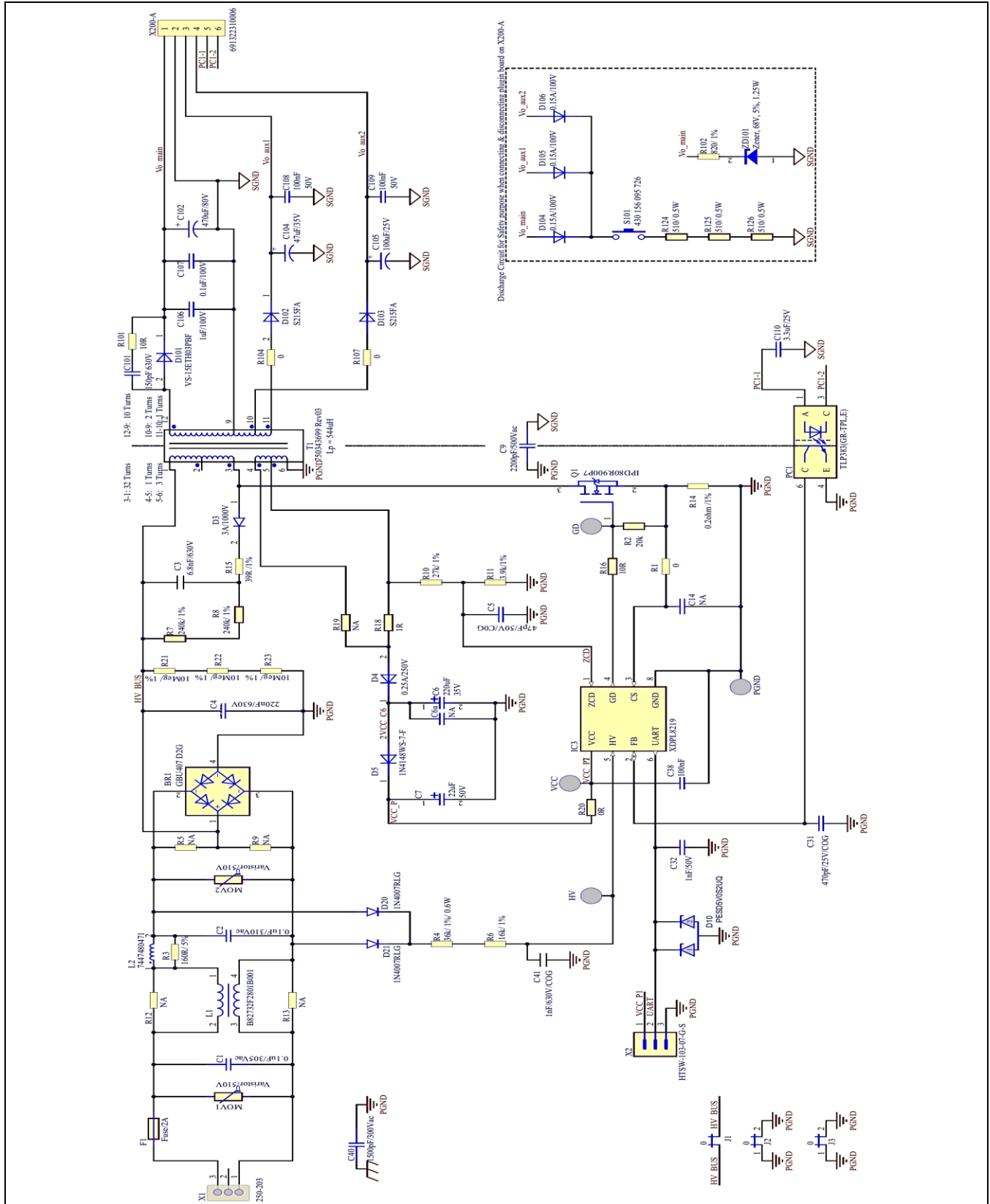

Figure 3 XDPL8219 40 W reference design main board schematic

XDPL8219 40 W reference design with IPD80R900P7

For high-power-factor flyback converter with constant voltage output

Schematic and PCB layout

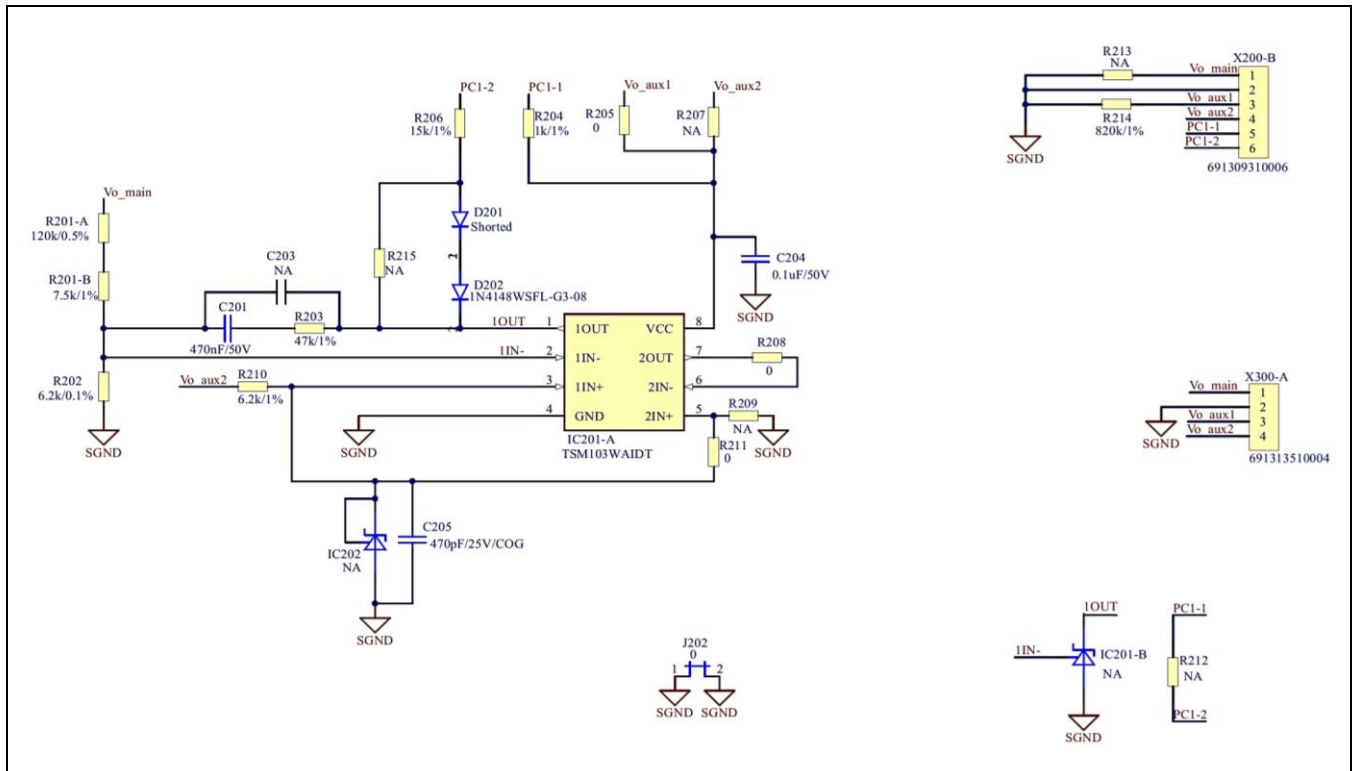

Figure 4 54 V CV SSR plug-in board schematic

Figure 5 shows the isolated UART reporting evaluation plug-in board schematic of this reference design.

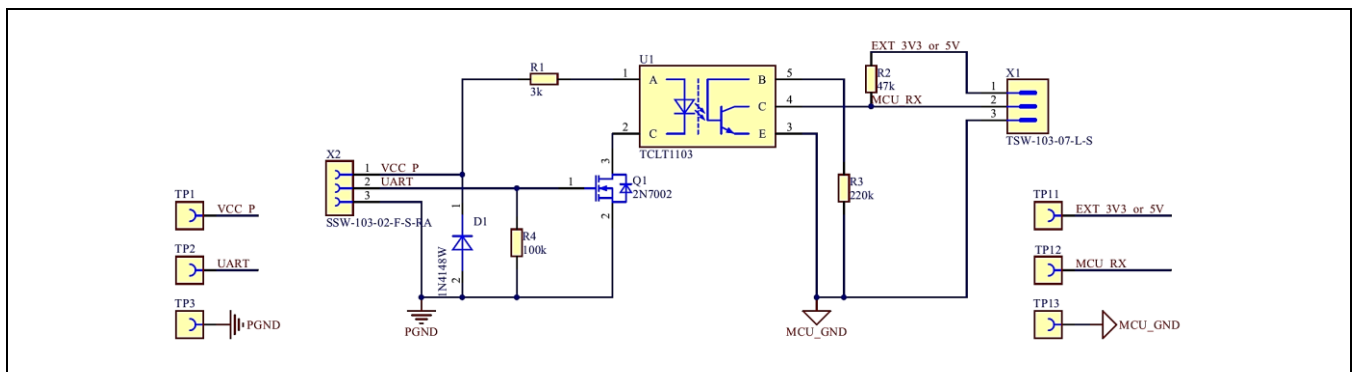

Figure 5 Isolated UART reporting evaluation plug-in board schematic

Both the XDPL8219 40 W reference design main board and 54 V CV SSR plug-in board have single-layer PCB layout design. Figure 6 and Figure 7 respectively show the PCB top layout (with dimensions) and bottom layout.

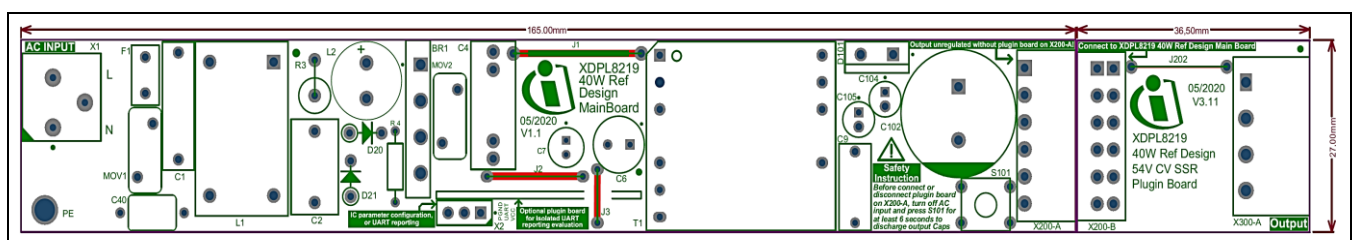

Figure 6 PCB top layout of main board and 54 V CV SSR plug-in board

XDPL8219 40 W reference design with IPD80R900P7
For high-power-factor flyback converter with constant voltage output
Schematic and PCB layout

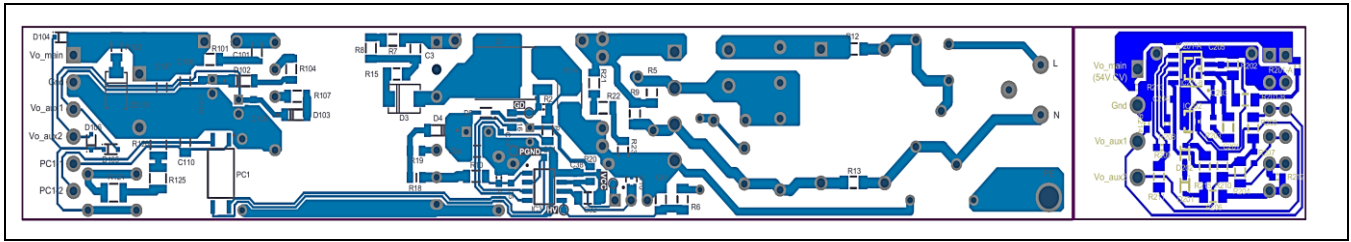

Figure 7 PCB bottom layout of main board and 54 V CV SSR plug-in board

The isolated UART reporting evaluation plug-in board has double-layer PCB layout design. **Figure 8** and **Figure 9** respectively show the PCB top layout (with dimensions) and bottom layout.

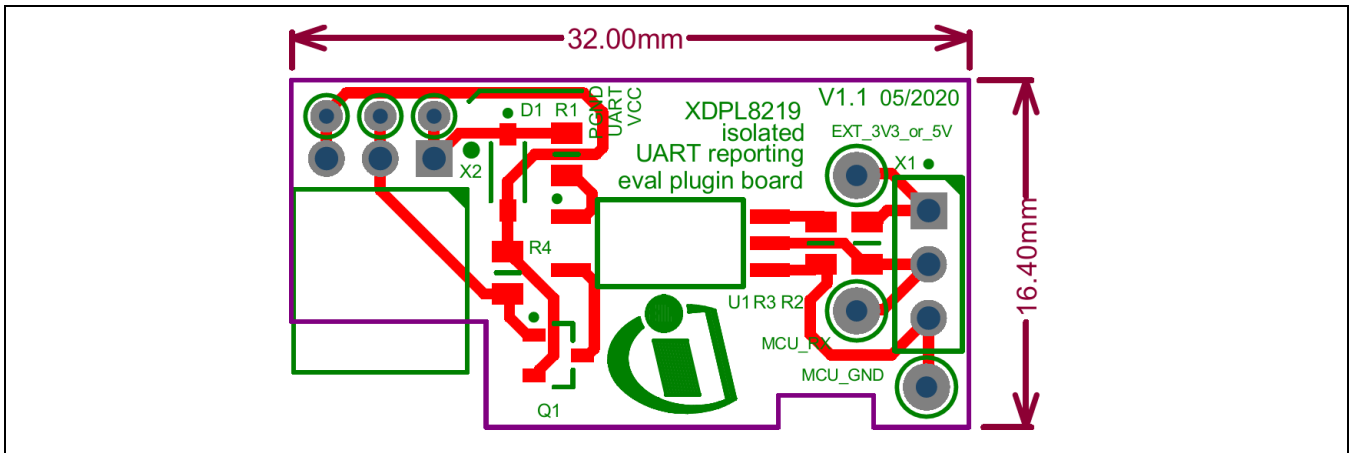

Figure 8 PCB top layout of isolated UART reporting evaluation plug-in board

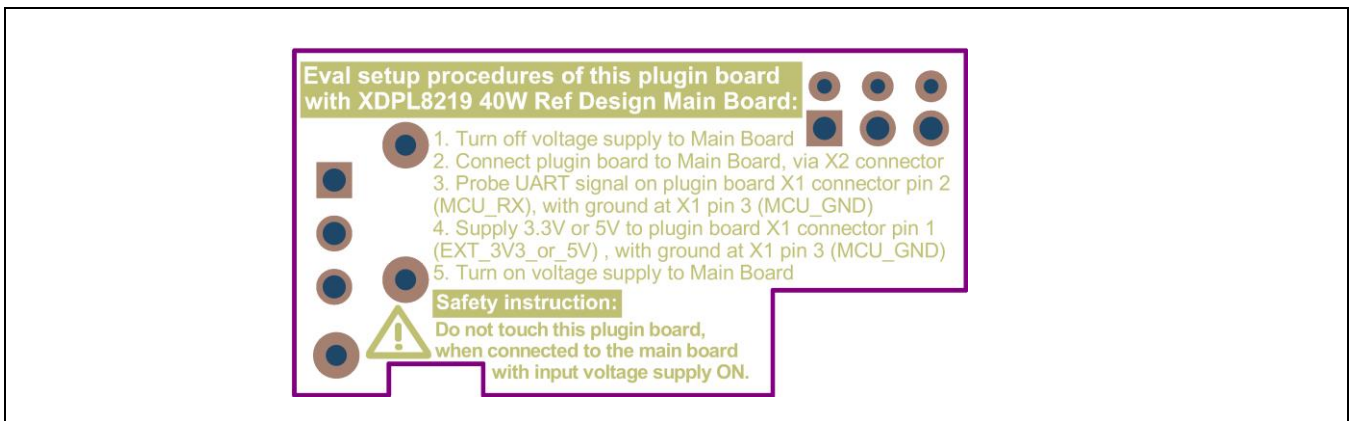

Figure 9 PCB bottom layout of isolated UART reporting evaluation plug-in board

Performance

5 Performance

The results shown in this section are based on the evaluation of a single reference board, at room temperature.

5.1 Line and load regulation

The total line and load regulation of V_{out} is within ± 1 percent, as shown in [Figure 10](#).

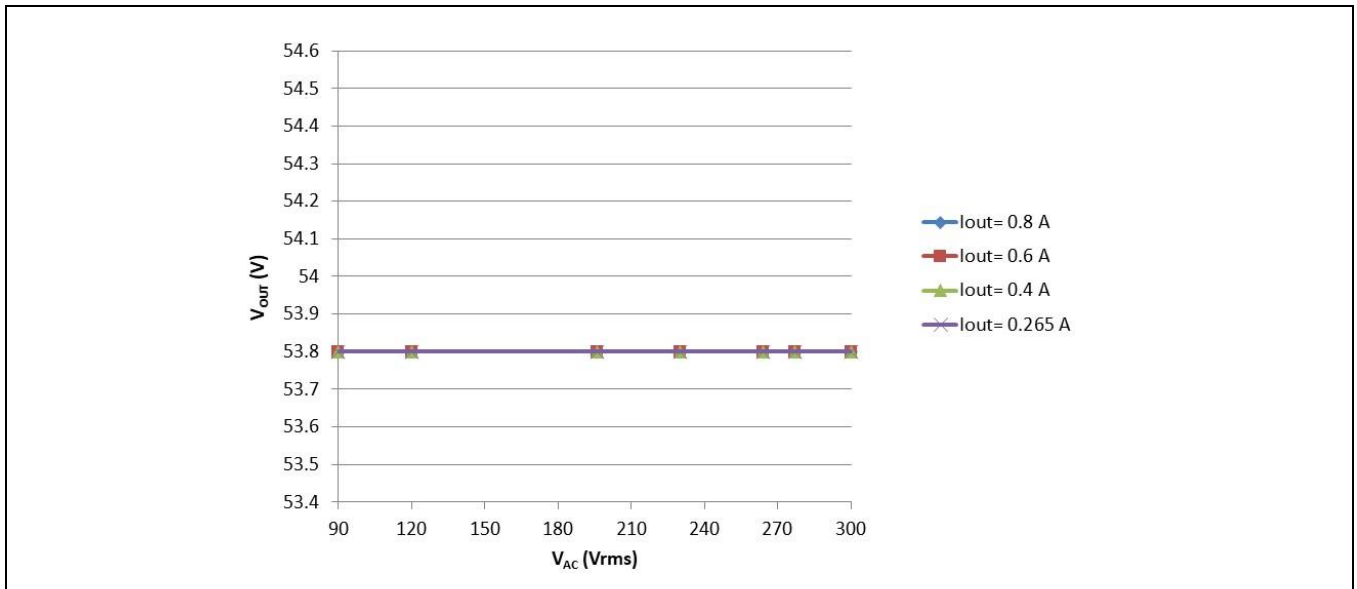

Figure 10 Line and load regulation test result

5.2 Power efficiency

The power efficiency is measured in the range of 90 percent to 93 percent, with a combination of wide output load range ($I_{out} = 265$ mA to 800 mA) and wide AC input voltage range ($V_{AC} = 120$ V_{rms} to 277 V_{rms}), as shown in [Figure 11](#).

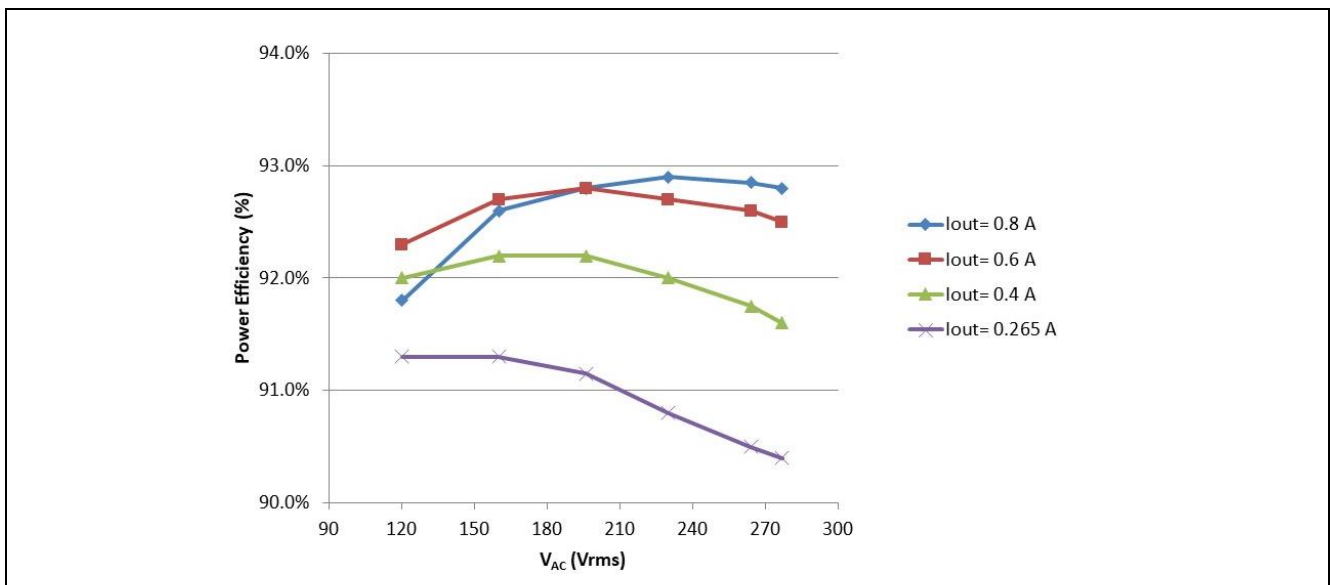

Figure 11 System efficiency test result

Performance

5.3 Standby power

The standby power under no-load condition is less than 100 mW, as shown in [Figure 12](#).

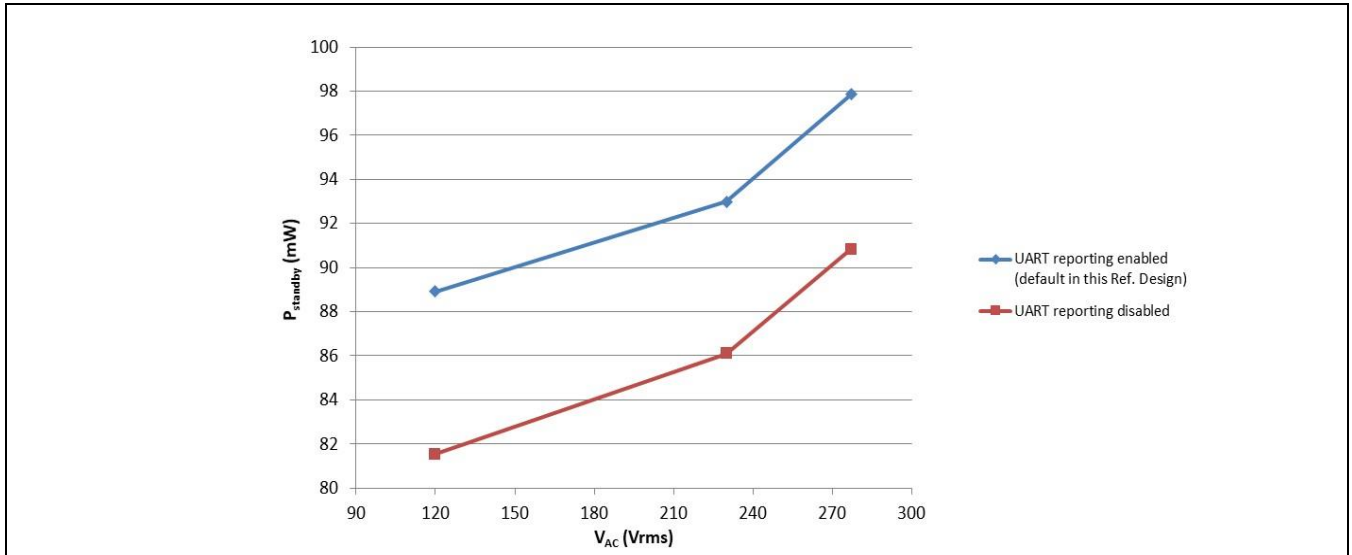

Figure 12 Standby power test result

5.4 Power factor and total harmonic distortion

Across both wide output load range ($I_{out} = 265 \text{ mA}$ to 800 mA) and wide input voltage ($V_{AC} = 90 \text{ V}_{rms}$ to 277 V_{rms}), the PF stays above 0.9, as shown in [Figure 13](#).

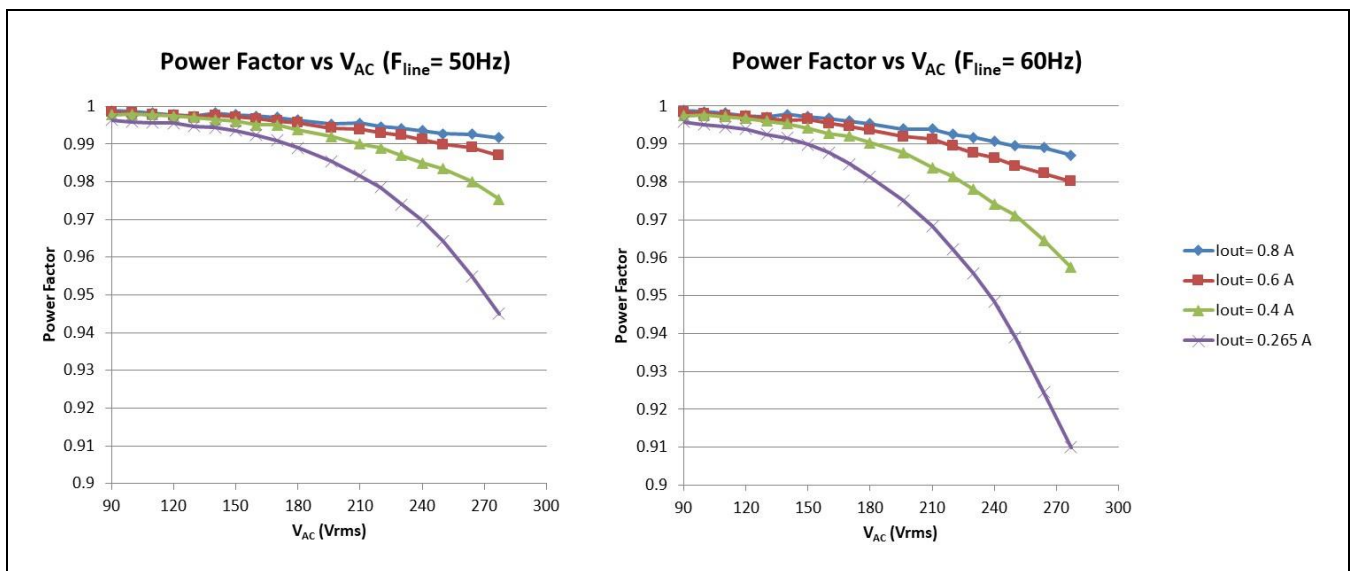

Figure 13 PF test result

Across wide output load range ($I_{out} = 265 \text{ mA}$ to 800 mA), the iTHD measurements shown in [Figure 14](#) are:

- Less than 10 percent with $V_{AC} = 230 \text{ V}_{rms}$ ($F_{line} = 50 \text{ Hz}$)
- Less than 15 percent with $V_{AC} = 120 \text{ V}_{rms}$ and 277 V_{rms} ($F_{line} = 60 \text{ Hz}$)

Performance

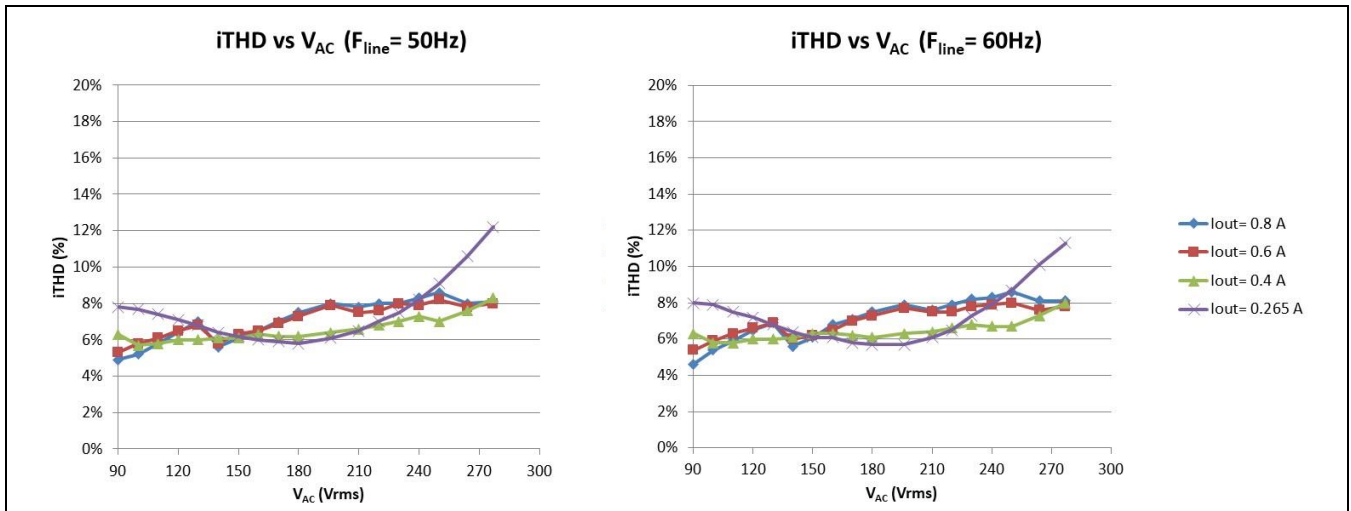

Figure 14 Total harmonic distortion (iTHD) test result

5.5 Current harmonics

Figure 15, Figure 16 and Figure 17 show the current harmonics measurement (IHD) compared to the IEC61000-3-2 Class C limits (IHD_{Limits}).

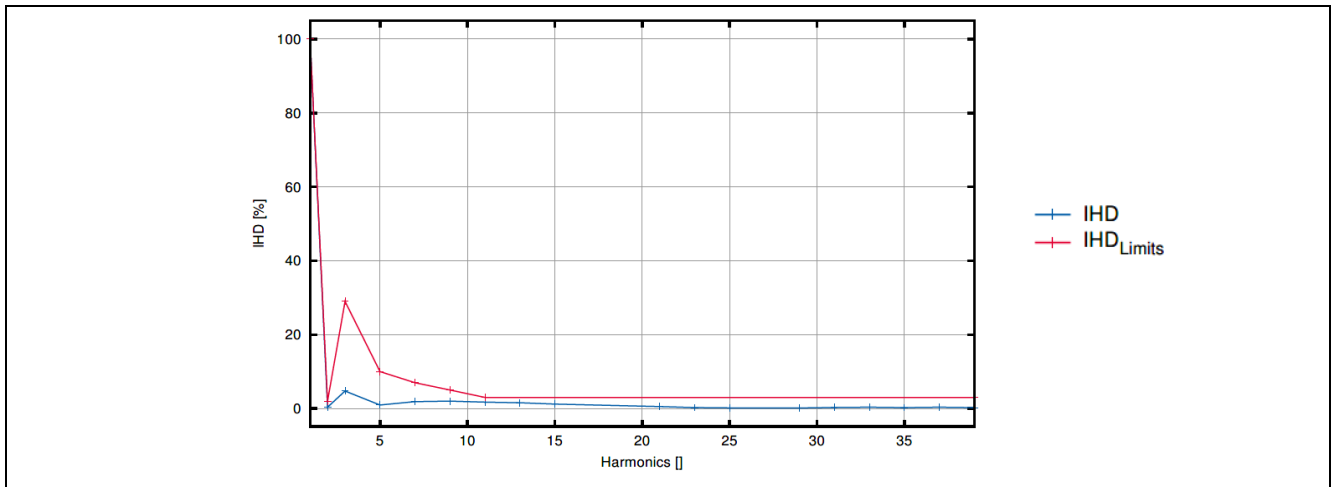

Figure 15 Current harmonics at V AC = 120 V_{rms}, F_{line} = 60 Hz and I_{out} = 0.8 A

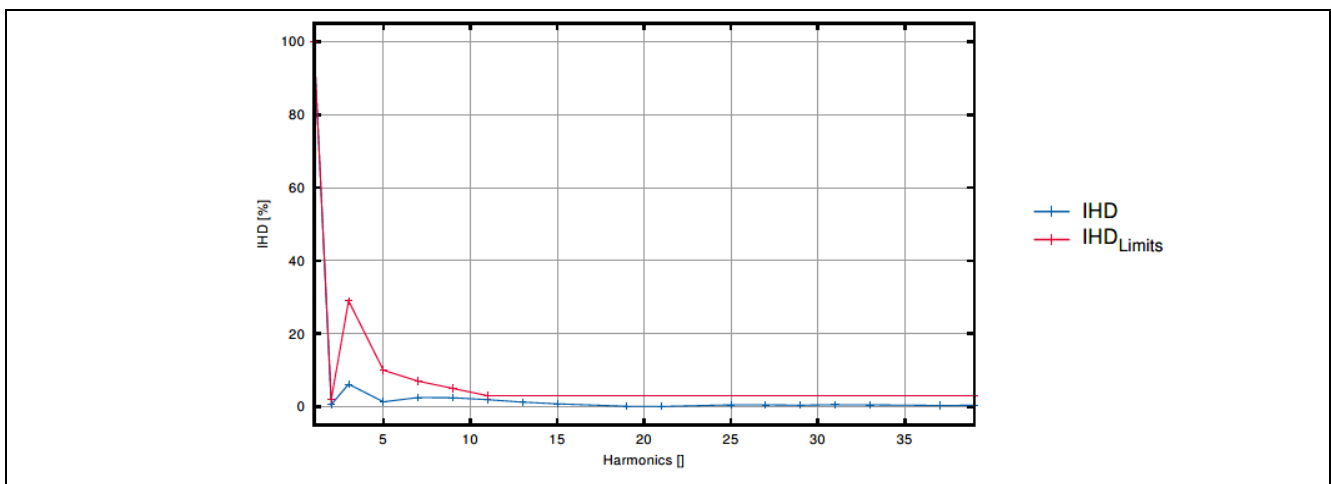

Figure 16 Current harmonics at V AC = 230 V_{rms}, F_{line} = 50 Hz and I_{out} = 0.8 A

Performance

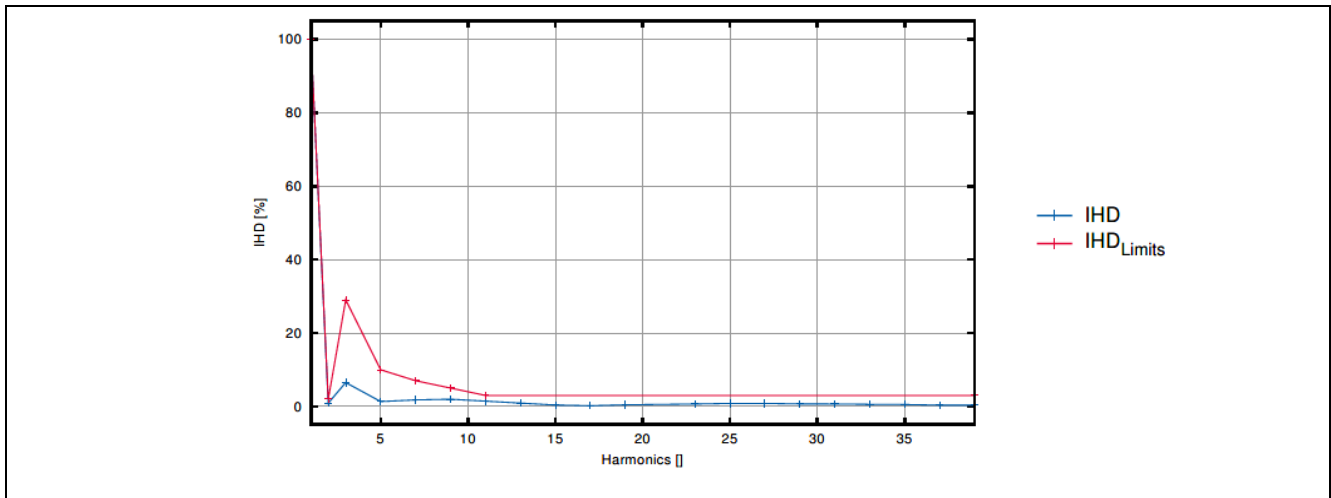

Figure 17 Current harmonics at $V_{AC} = 277 V_{rms}$, $F_{line} = 60 Hz$ and $I_{out} = 0.8 A$

5.6 Input UV protection and brown-out power limitation

To better protect the primary components, e.g., the flyback MOSFET, from overheating and the magnetics from saturation, **XDPL8219** features not only an input UVP (via ZCD and CS pin signal sensing) with configurable threshold for output on/off, but also a configurable brown-out power limitation slope. **Figure 18** shows the $t_{on,max,at,V,in,low}$, $t_{on,max,at,V,in,UV}$, $V_{in,UV}$ and $V_{in,low}$ parameter configuration in this reference design, which affects the maximum on-time reduction slope, and the brown-out power limitation slope test result.

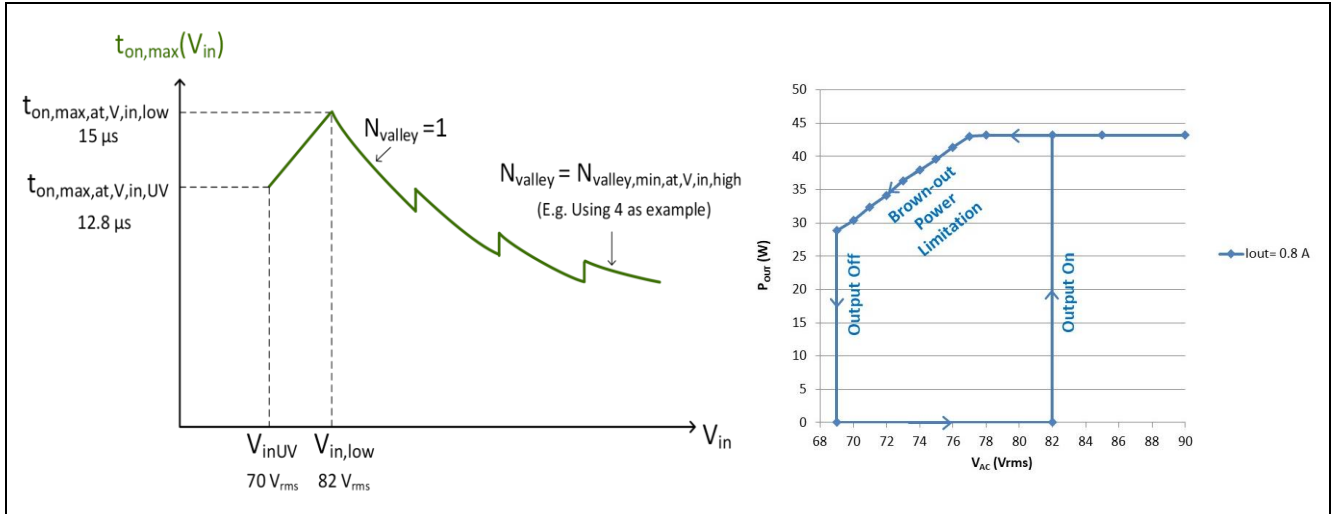

Figure 18 Input UV protection and brown-out power limitation with maximum on-time reduction

5.7 Regulated mode output UV protection and output power limitation under single fault condition

Under the single fault condition of second-stage CC converter MOSFET drain and source pins being shorted, the connected output LEDs could clamp the flyback output voltage below its constant voltage regulation set-point.

To limit the flyback output power to the LEDs below 100 VA as per UL1310 requirements under such a fault condition, especially at high input voltage, **XDPL8219** regulated mode features the regulated mode CS pin maximum voltage limit $V_{OCP1}(V_{in})$ and minimum valley number limit $N_{valley}(V_{in})$, which are adaptive based on the estimated input voltage V_{in} .

Performance

Figure 19 shows the $V_{OCP1,at,V_{in,low}}$, $V_{OCP1,at,V_{in,high}}$, $N_{valley,min,at,V_{in,high}}$, $V_{in,low}$ and $V_{in,high}$ parameter configuration in this reference design, which affects the output power limitation curve test result, under such a single fault condition.

In case the single fault condition mentioned above occurs in conjunction with low-output LED voltage, **XDPL8219** also features a regulated mode output UVP (via ZCD pin signal sensing), which can be triggered to prevent the flyback MOSFET from continuously operating in the saturation region with low gate drive and V_{CC} voltages, as shown in the test result in **Figure 19**.

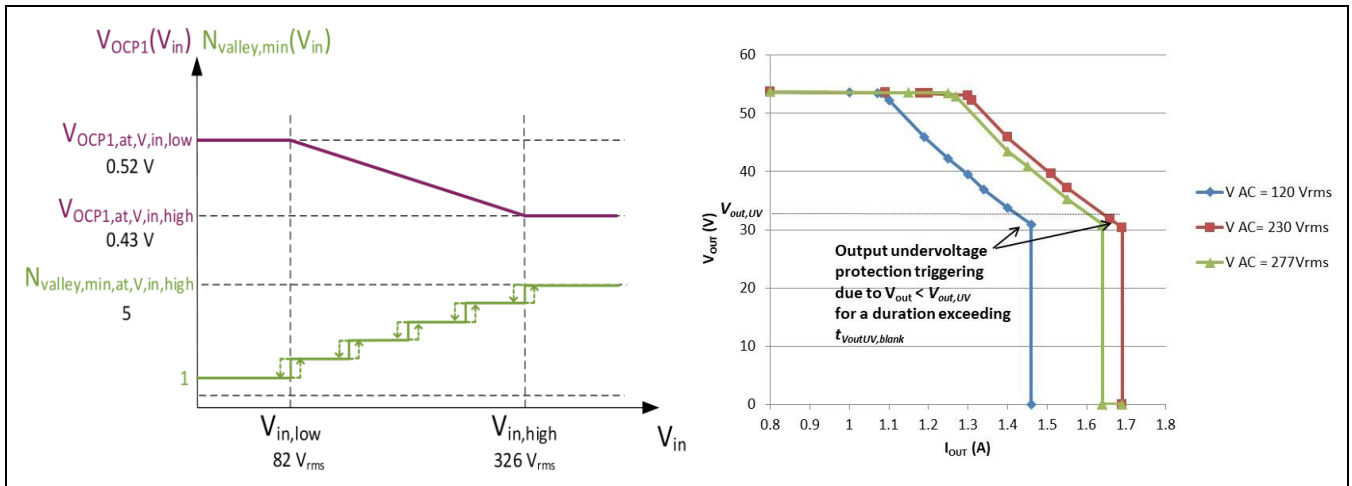

Figure 19 Regulated mode output UV protection, and output power limitation based on regulated mode CS pin maximum voltage limit and minimum valley number limit

5.8 UART reporting

The **XDPL8219** UART pin reporting signals can be probed from the main board’s X2 connector pin 2, with the grounding on X2 connector pin 3. With the default $UART_{polarity} = \text{“Low”}$ parameterization in this reference design, the oscilloscope settings for data decoding should be based on logic level of low = 1 and high = 0, with a baud rate of 9600 bps.

The captured UART signals in **Section 5.8.1**, **Section 5.8.2** and **Section 5.8.3** are based on such a setup.

5.8.1 Regular data reporting

With the $EN_{UART,REPORTING}$ parameter enabled by default in this reference design, the **XDPL8219** UART pin transmits a regular data packet once every 14 operation cycles, which contains the following information:

- Last detected line frequency or input voltage type based on $F_{line,UART}$
- Last estimated input voltage rms value V_{in}
- Last measured IC junction temperature $T_{J,UART}$, based on its internal sensor

Note: In ABM, the $F_{line,UART}$ cannot be synchronized with the input voltage frequency, for power savings. It only shows the last detected values before entering ABM.

The UART reporting system information is useful for power monitoring, and also for improving reliability, for example reducing the second-stage CC regulator maximum output power, when the V_{in} drops too low or $T_{J,UART}$ rises too high.

Figure 20 shows an example of the captured and decoded regular data packet.

Performance

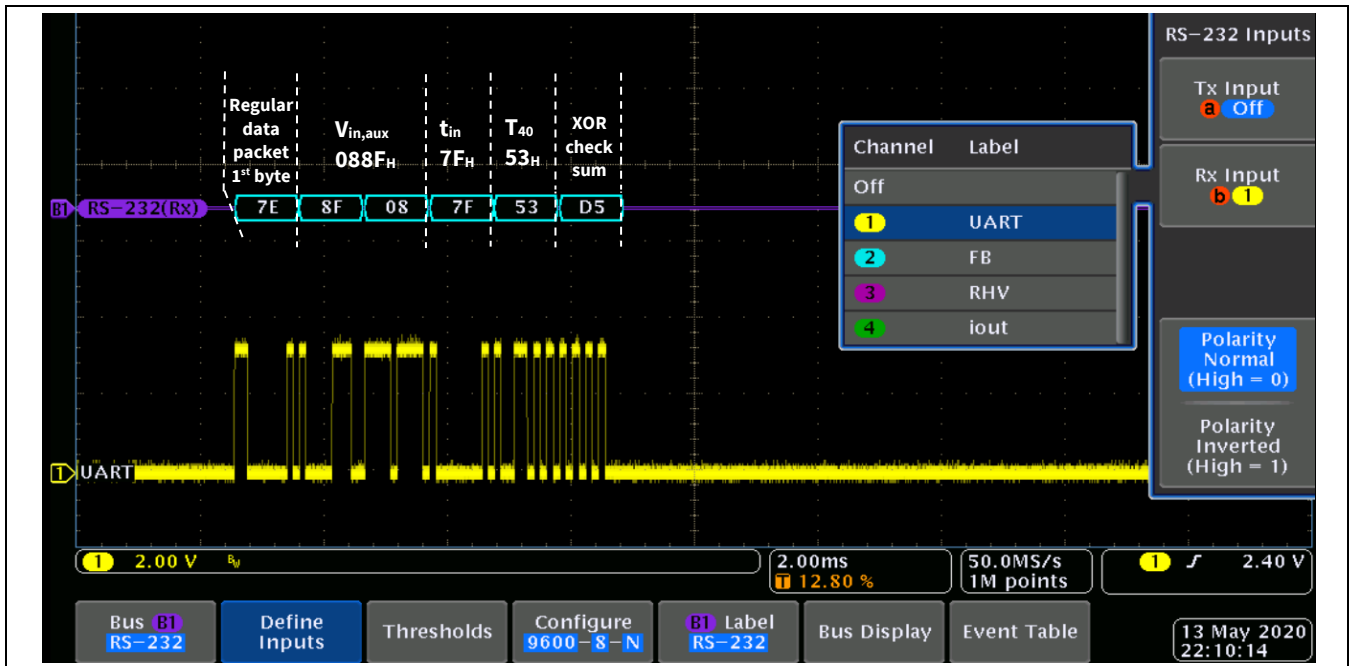

Figure 20 UART regular data packet capturing and decoding

Based on **Table 3**, the decoded UART regular data ($V_{in,aux}$, t_{in} and T_{40}) can be interpreted to obtain the system information (e.g., line frequency $F_{line,UART}$, input voltage V_{in} and IC junction temperature $T_{J,UART}$).

Table 3 Interpretation of the decoded regular data

UART data	Data interpretation	Example of data interpretation based on the decoded data in Figure 20
t_{in}	<p>If $t_{in} = FF_H$, the input voltage type has not been detected. If $t_{in} = 00_H$, the last detected input voltage type is constant DC. If $t_{in} \neq FF_H$ and $t_{in} \neq 00_H$, the last detected input voltage type is AC and the $F_{line,UART}$ (unit: Hz) can be calculated based on:</p> $F_{line,UART} = \begin{cases} 5828/t_{in}, & T_{critical} > 119^{\circ}C \\ 7726/t_{in}, & T_{critical} \leq 119^{\circ}C \end{cases}$ <p>Where $T_{critical}$ is the IC overtemperature protection level parameter setting.</p>	<p>Based on $t_{in} = 7F_H \neq FF_H \neq 00_H$, the last detected input voltage type is AC.</p> <p>Based on $T_{critical} = 119^{\circ}C$ configuration in this reference design, the AC input frequency $F_{line,UART}$ equation is selected: $F_{line,UART} = 7726/t_{in}$</p> <p>Based on $t_{in} = 7F_H = 127$, $F_{line,UART} = 60.83 \text{ Hz}$</p>
$V_{in,aux}$	$V_{in} = \begin{cases} 0.005460 \cdot V_{in,aux} \cdot N_p/N_a, & t_{in} \neq FF_H \text{ and } t_{in} \neq 00_H \\ 0.007722 \cdot V_{in,aux} \cdot N_p/N_a, & t_{in} = 00_H \end{cases}$	<p>Based on $t_{in} = 7F_H \neq FF_H \neq 00_H$, the V_{in} equation is selected: $V_{in} = 0.005460 \cdot V_{in,aux} \cdot N_p/N_a$</p> <p>Based on $V_{in,aux} = 088F_H = 2191$, with $N_p = 32$ and $N_a = 3$ configuration in this reference design, $V_{in} = 0.005460 \cdot 2191 \cdot 32/3$ $= 127.6 \text{ V}_{rms}$</p>
T_{40}	$T_{J,UART} = T_{40} - 40$	<p>Based on $T_{40} = 53_H = 83$, $T_{J,UART} = T_{40} - 40$ $= 43^{\circ}C$</p>

Performance

The single board test result shows that the UART reporting input voltage V_{in} averaging value deviates in the range of 0.2 percent to 6.4 percent from the actual input voltage, as shown in **Figure 21**.

For higher input voltage monitoring accuracy, the microcontroller should store the necessary calibration data for its post-processing, to compensate for the offset on V_{in} , which varies based on the IC and system tolerances of each board.

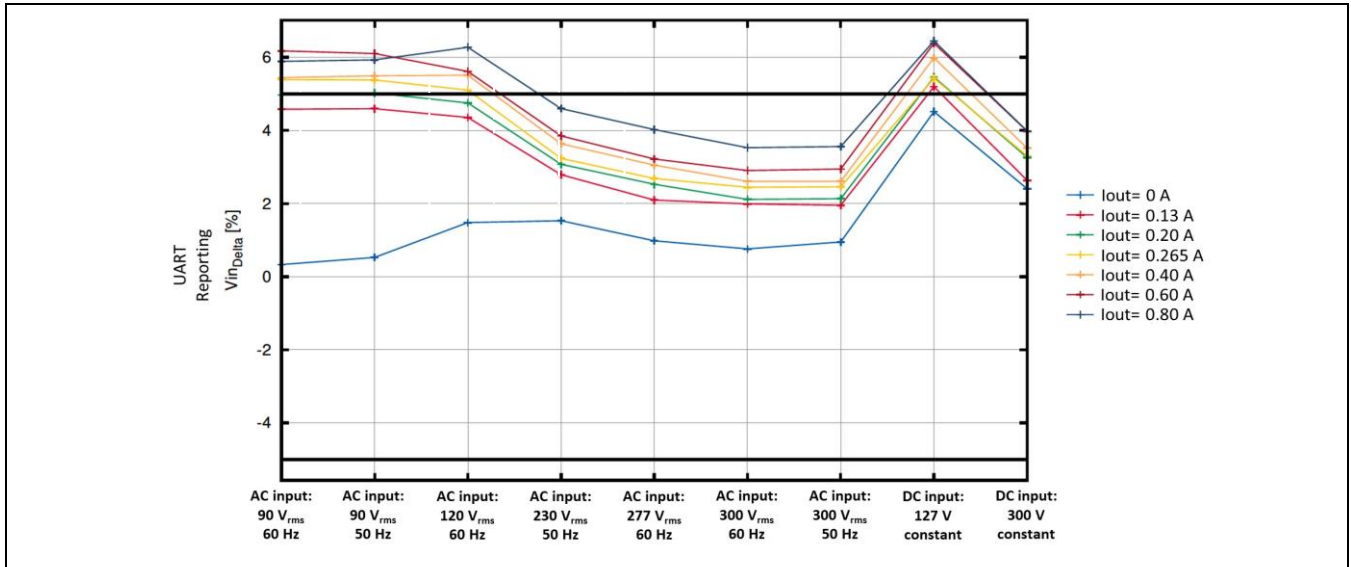

Figure 21 UART reporting input voltage deviation test result

The single board test result shows that the UART reporting line frequency $F_{line,UART}$ averaging value deviates in the range of -0.4 percent to 1.3 percent from the actual AC input frequency, as shown in **Figure 22**. It is important to note that the $F_{line,UART}$ deviation data below is measured with static input and output conditions applied from start-up to steady-state. As the $F_{line,UART}$ cannot be synchronized with the AC input frequency in ABM, some $F_{line,UART}$ deviation data below obtained under ABM operation (e.g., with $I_{out} = 0$ A) can therefore become invalid, if the line frequency changes (e.g., from 50 Hz to 60 Hz, or vice-versa) after start-up.

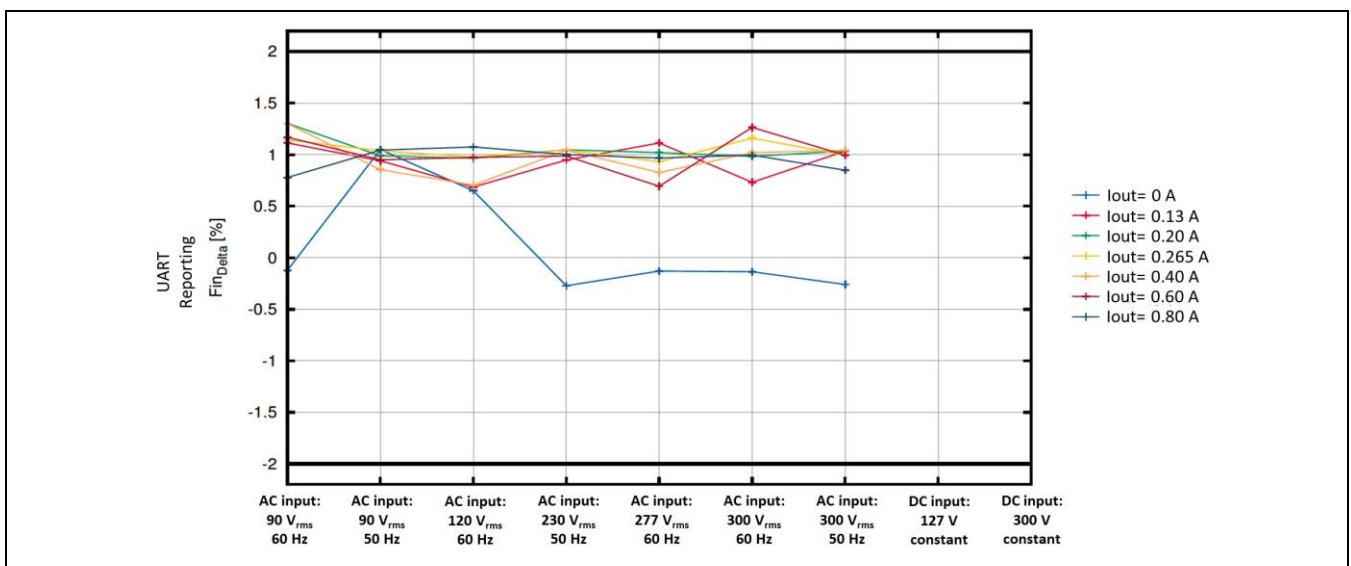

Figure 22 UART reporting line frequency deviation test result

The UART reporting IC junction temperature $T_{J,UART}$ sample deviates in the range of -6 percent to 6 percent from the actual IC junction temperature.

Performance

5.8.2 Input voltage loss reporting

With both $EN_{UART,REPORTING}$ and $EN_{SEND,V,IN,LOSS}$ parameters enabled by default in this reference design, the **XDPL8219** UART pin transmits either 40_H data packet(s), or a number of ED_H data within the regular data packet, or both, to indicate the input voltage loss, if the consecutive number of too-low ZCD pin clamping current $-I_{IV}$ sampling values have exceeded a limit.

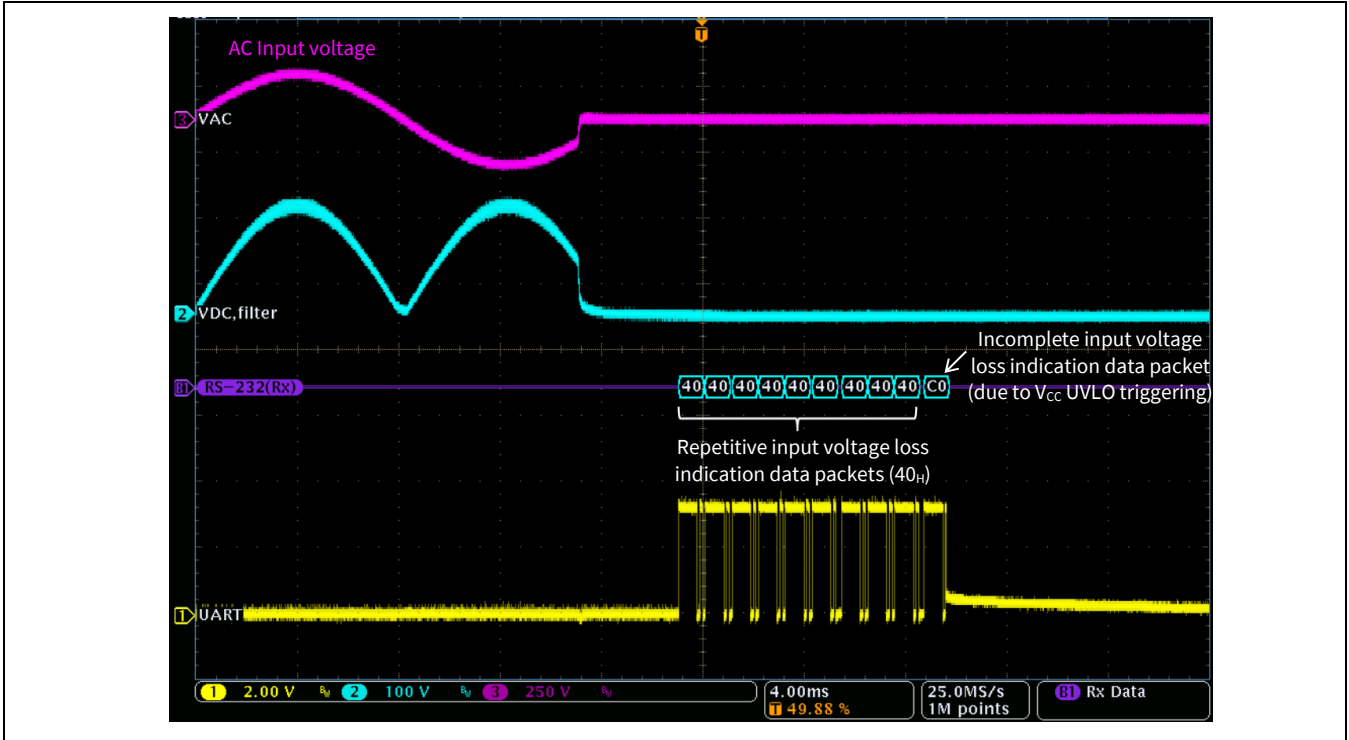

Figure 23 Typical input voltage loss indication – data packets capturing and decoding (40_H)

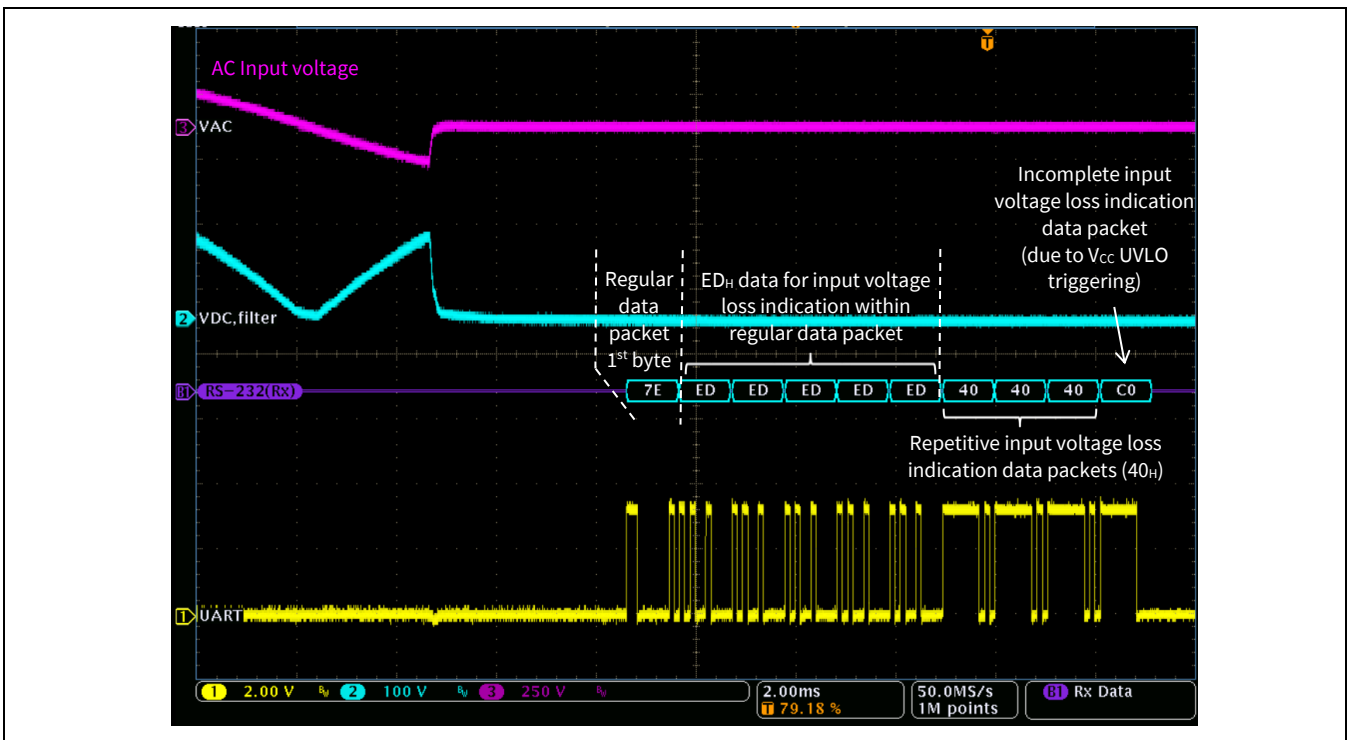

Figure 24 Input voltage loss indication within regular data packet capturing and decoding (ED_H)

Performance

5.8.3 Error code reporting

With both EN_{UART,REPORTING} and EN_{SEND,LAST;ERROR;CODE} parameters enabled by default in this reference design, the XDPL8219 UART pin transmits a data packet which contains the error code of the last triggered protection, right before every auto restart.

If the triggered protection reaction is hardware restart, stop-mode or latch-mode, the error code will not be sent out. For example, if the V_{CC} OVP has been triggered, with the default V_{CC} OVP reaction parameter setting of Reaction_{V_{CC},OVP} = “Latch-Mode” in this reference design, the UART reporting error code data packet will not be sent out.

Figure 25 shows an example of capturing and decoding the error code data packet, by zooming into the UART signal at auto restart, after the protection has been triggered. According to Table 4, the obtained error code of FFEF_H shows that the last triggered protection is start-up output UVP.

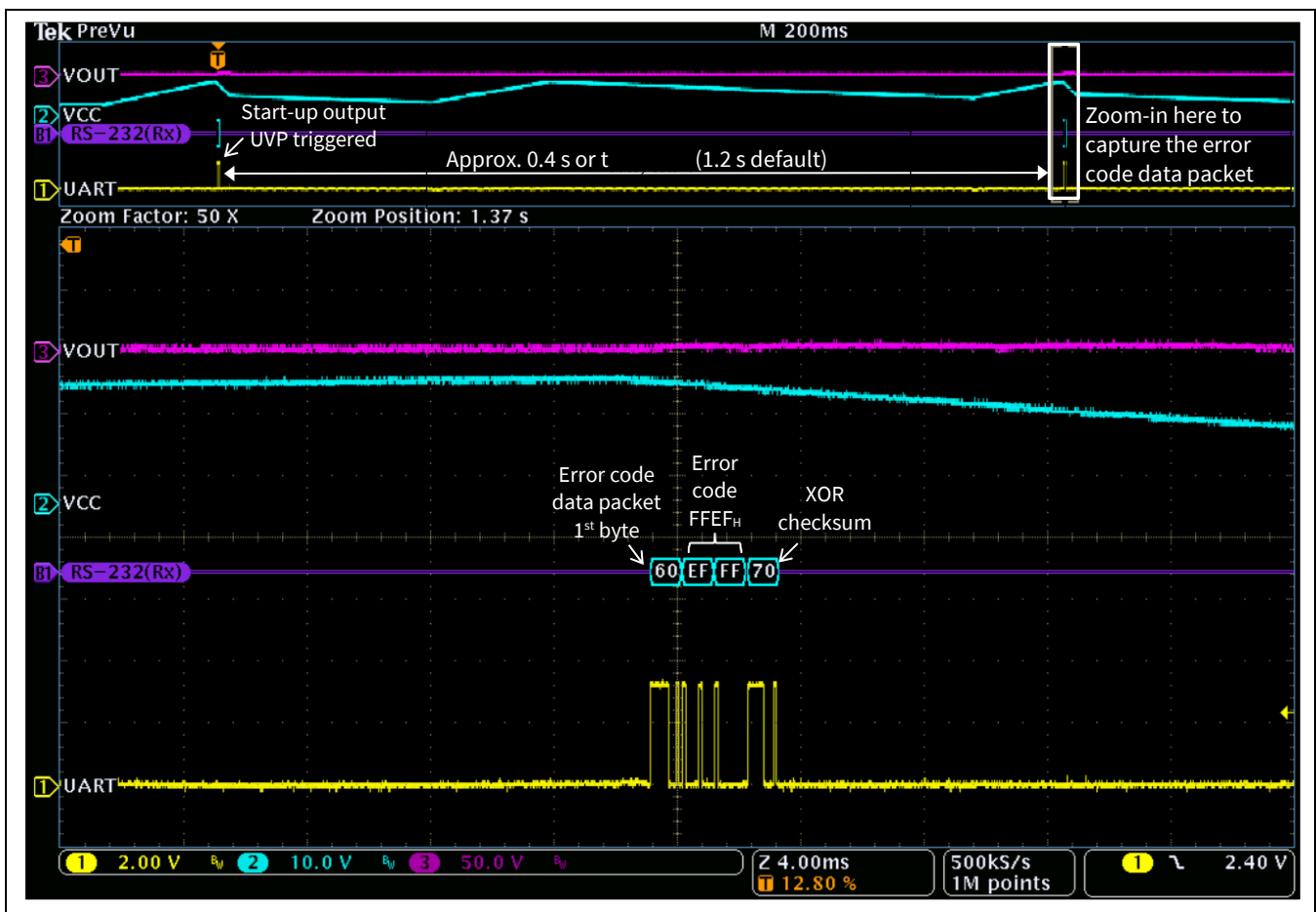

Figure 25 Error code data packet capturing and decoding (FFEF_H, as an example)

Table 4 UART reporting error code data interpretation

Error code data		Last triggered protection
UART _{polarity} = high	UART _{polarity} = low	
0000 _H	FFFF _H	None
0001 _H	FFFE _H	Output OVP
0008 _H	FFF7 _H	Regulated mode output UVP
0010 _H	FFEF _H	Start-up output UVP

Performance

Error code		Last triggered protection
UART _{polarity = high}	UART _{polarity = low}	
0020 _H	FFDF _H	Transformer demagnetization time shortage protection
0040 _H	FFBF _H	Input UVP
0080 _H	FF7F _H	Input OVP
0100 _H	FEFF _H	IC overtemperature protection
0200 _H	FDFE _H	V _{CC} OVP
0400 _H	FBFF _H	Interrupt watchdog protection (may get triggered for input UVP)
0800 _H	F7FF _H	MOSFET over-current protection
4000 _H	BFFF _H	ADC watchdog protection (may get triggered for input UVP)
8000 _H	7FFF _H	Regulated mode V _{CC} UVP

5.9 Isolated UART reporting

If the UART reporting signals are to be probed from the isolated UART reporting evaluation plug-in board's connector X1 (based on the recommended setup and procedures printed on the PCB), the default UART_{polarity} = "Low" parameter setting in this reference design must be used, so the captured UART signals shown in [Section 5.8.1](#), [Section 5.8.2](#) and [Section 5.8.3](#) will be inverted.

For such a setup, the oscilloscope settings for data decoding should be based on logic level of low = 0 and high = 1, with a baud rate of 9600 bps.

5.10 Thermal test

The open-frame thermal test was done on the reference design using an infrared thermography camera at an ambient temperature of approximately 25°C. The temperature measurements of the following main components (see [Table 5](#)) were taken after 2 hours' running.

Table 5 Main components for temperature measurement

PCB bottom			PCB top		
Measure point	Component	Description	Measure point	Component	Description
sp1	Q1	Flyback MOSFET (IPD80R900P7)	sp1	T1	Flyback transformer
sp2	IC3	Flyback controller (XDPL8219)	sp2	D101	Secondary main output diode
			sp3	PCB	PCB above Q1

Performance

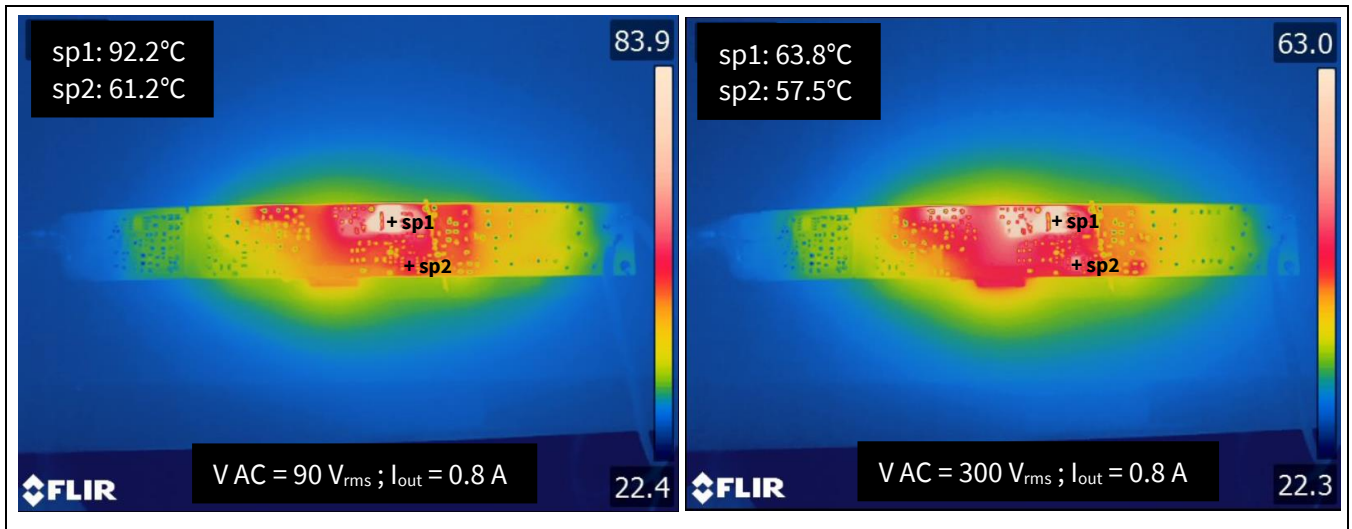

Figure 26 Infrared thermal image result of PCB bottom components

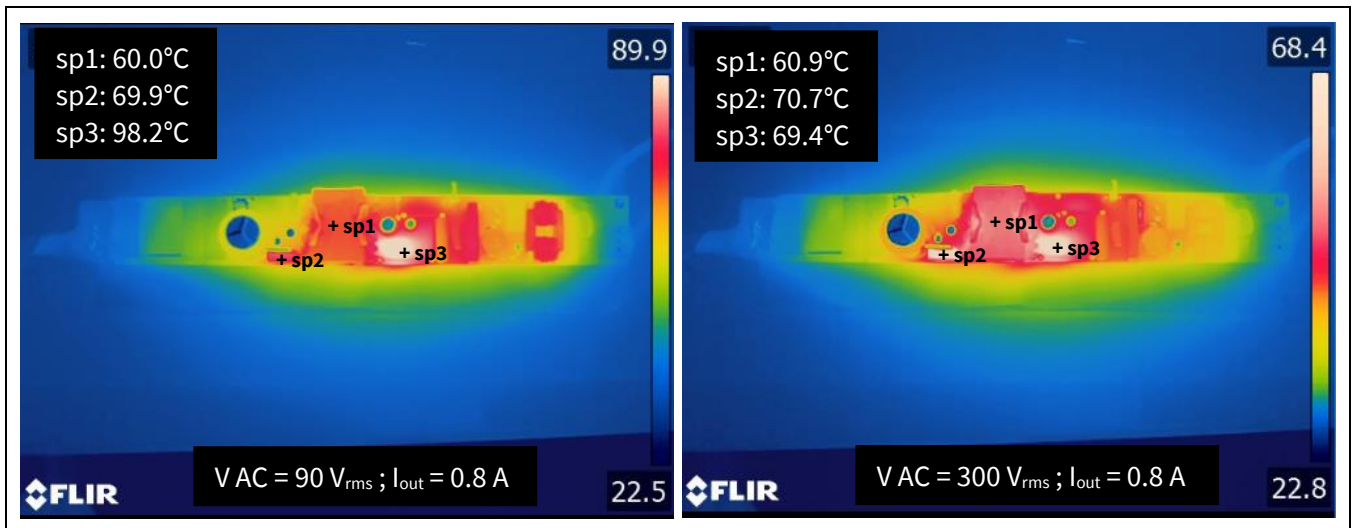

Figure 27 Infrared thermal image result of PCB top components

6 BOM and transformer specifications

This section provides the BOM and the transformer specifications.

6.1 BOM

Table 6 BOM of main board

Designator	Value	Part number	Manufacturer
BR1	Bridge rectifier/4 A/1000 V	GBU407 D2G	Taiwan Semiconductor
C1	0.1 μ F/305V AC	B32922C3104K	EPCOS
C2	0.1 μ F/310 V AC	890334023023CS	Würth
C3	6.8 nF/630 V	GRM31BR72J682KW01L	Murata
C4	220 nF/630 V	ECW-FA2J224J	Panasonic
C5	47 pF/50 V/C0G	CL10C470JB8NNNC	Samsung Electro-Mechanics
C6	220 μ F/35 V/20 percent	EKMG350EC3221MHB5D	Nippon Chemi-Con
C7	22 μ F/50 V/20 percent	50PX22MEFC5X11	Rubycon
C9	2200 pF/500 V AC	VY1222M47Y5UQ63V0	Vishay
C31	470 pF/25 V/COG	06033A471JAT2A	AVX
C32	1 nF/50 V	12065C102KAT2A	AVX
C38, C108, C109	100 nF/50 V/X7R/10 percent	CL10B104KB8NNNC	Samsung Electro-Mechanics
C40	1500 pF/300 V AC	DE1E3KX152MN4AP01F	Murata
C41	1 nF/630 V/COG	GRM31B5C2J102JW01L	Murata
C101	150 pF/630 V/C0G/5 percent	GRM31A5C2J151JW01	Murata
C102	470 μ F/80 V	EKZE800ELL471MM20S	United Chemi-Con
C104	47 μ F/35 V	ECA1VHG470	Panasonic
C105	100 μ F/25 V	UVY1E101MDD	Nichicon
C106	1 μ F/100 V/X7R/10 percent	12061C105K4Z2A	AVX
C107	0.1 μ F/100 V	12061C104KAT2A	AVX
C110	3.3 μ F/25V	CGA5L1X7R1E335K160AC	TDK
D3	Fast diode/3 A/1 kV	RS3MB-13-F	DIODES
D4	Fast diode/0.25 A/250 V	BAV103,115	Nexperia
D102, D103	Schottky diode/2 A/150 V	S215FA	Onsemi
D5	Fast diode/0.15 A/100 V	1N4148WS-7-F	Diodes Incorporated
D10	ESD diode/6.8 V	PESD5V0S2UQ,115	Nexperia
D20, D21	Standard diode/1 A/1000 V	1N4007RLG	ON Semi
D101	Hyper-fast diode/15 A/300 V	VS-15ETH03PBF	Vishay
D104, D105, D106	Fast diode/0.15 A/100 V	1N4148WS-E3-18	Vishay
F1	Fuse/2 A	MCMSF 2 A 250 V	Multicomp
IC3	Flyback controller	XDPL8219	Infineon
J1	20 mm pitch jumper with insulated sleeving	TCW21 250G	PRO Power
J2	15 mm pitch jumper	TCW21 250G	PRO Power
J3	7.5 mm pitch jumper	TCW21 250G	PRO Power
L1	Common mode choke/39 mH/0.8 A	B82732F2801B001	Epcos
L2	Differential choke/470 μ H/1.15 A	7447480471	Würth

XDPL8219 40 W reference design with IPD80R900P7

For high-power-factor flyback converter with constant voltage output

BOM and transformer specifications



Designator	Value	Part number	Manufacturer
MOV1, MOV2	Varistor/510 V/10 percent	ERZE08A511	Panasonic
PC1	Optocoupler/100 percent CTR	TLP383(GR-TPL,E)	Toshiba
Q1	MOSFET/0.9 Ω /800 V	IPD80R900P7	Infineon
R1, R104, R107	0 R	RC1206JR-070RL	Yageo/Phycomp
R2	20 k	AC0603FR-0720KL	Yageo/Phycomp
R3	160 R/2 W/5 percent	ERG-2SJ161V	Panasonic
R4	36 k	LR1F36K	TE
R6	16 k	ERJ-8ENF1602V	Panasonic
R7, R8	240 k	WCR1206-240KFI	Welwyn
R10	27 k	MCSR12X2702FTL	Multicomp
R11	3.9 k	MCWR06X3901FTL	Multicomp
R14	0.2	LR2010-R20FW	Welwyn
R15	39 R	ERJ-8ENF39R0V	Panasonic
R16	10 R	CRCW080510R0FK	Vishay
R18	1 R	CRCW08051R00FK	Vishay
R20	0 R	RC0805JR-070RL	Yageo
R21, R22, R23	10 Meg	CRCW120610M0FKEB	Vishay
R101	10 R	RC1206FR-0710RL	Yageo/Phycomp
R102	820 R	RMCF1206FT820R	Stackpole Electronics Inc
R124, R125, R126	510 R	ERJU14F5100U	Panasonic
S101	Tactile switch	430 156 095 726	Würth
T1	PQ2620; 544 μ H; Np = 32; Ns = 10; Na(5-6) = 3; Na(4-5) = 1; Na,sec(11-10) = 1; Na,sec(10-9) = 2	750343699 Rev03	Würth
X1	Terminal strip/3 pins/3.5 mm pitch	250-203	WAGO
X2	Header/3 pins/2.54 mm pitch	HTSW-103-07-G-S	Samtec
X200-A	Terminal block/6 pins/3.81 mm pitch	691322310006	Würth
ZD101	Zener/68 V/5 percent/1.25 W	SML4760A-E3/61	Vishay

Table 7 BOM of 54 V CV SSR plug-in board

Designator	Value	Part number	Manufacturer
C201	470 nF/50 V	12065C474KAT2A	AVX
C204	0.1 μ F/50 V	MC0603B104K500CT	Multicomp
C205	470 pF/25 V/COG	06033A471JAT2A	AVX
D201	0 R	RC0603JR-070RL	Yageo/Phycomp
D202	Fast diode/0.15 A/100 V	1N4148WS-E3-18	Vishay
IC201-A	Op-amp IC with reference voltage	TSM103WAIDT	ST
J202	15 mm pitch jumper	TCW21 250G	PRO Power
R201-A	120 k	RR0816P-124D	Susumu
R201-B	7.5 k	MCMR12X7501FTL	Multicomp
R202	6.2 k	ERA-8AEB622V	Panasonic
R203	47 k	CRCW060347K0FK	Vishay

XDPL8219 40 W reference design with IPD80R900P7
For high-power-factor flyback converter with constant voltage output



BOM and transformer specifications

Designator	Value	Part number	Manufacturer
R204	1 k	MCWR12X1001FTL	Multicomp
R205, R211	0 R	RC1206JR-070RL	Yageo/Phycomp
R206	15 k	RC1206FR-0715KL	Yageo/Phycomp
R208	0 R	RC0603JR-070RL	Yageo/Phycomp
R210	6.2 k	MCWR12X6201FTL	Multicomp
R214	820 k	MCWR06X8203FTL	Multicomp
X200-B	Terminal block/6 pins/3.81 mm pitch	691309310006	Würth
X300-A	Terminal block/4 pins/5.08 mm pitch	691313510004	Würth

Table 8 BOM of Isolated UART evaluation plug-in board

Designator	Value	Part number	Manufacturer
D1	Fast diode/0.15 A/100 V	Diodes Incorporated	1N4148W-7-F
Q1	Small-signal MOSFET/60 V	Infineon Technologies	2N7002
R1	3 k	Vishay	CRCW08053K00FK
R2	47 k	Vishay	CRCW080547K0FK
R3	220 k	Vishay	CRCW0805220KFK
R4	100 k	Vishay	CRCW0805100KFK
U1	Optocoupler, phototransistor output	Vishay	TCLT1103
X1	Board-to-board connector/3 pin/2.54 mm pitch	Amphenol ICC (FCI)	68001-103HLF
X2	Header/3 pins/2.54 mm pitch	Sullins	PPPC031LGBN-RC

XDPL8219 40 W reference design with IPD80R900P7
For high-power-factor flyback converter with constant voltage output
BOM and transformer specifications



6.2 Transformer specifications

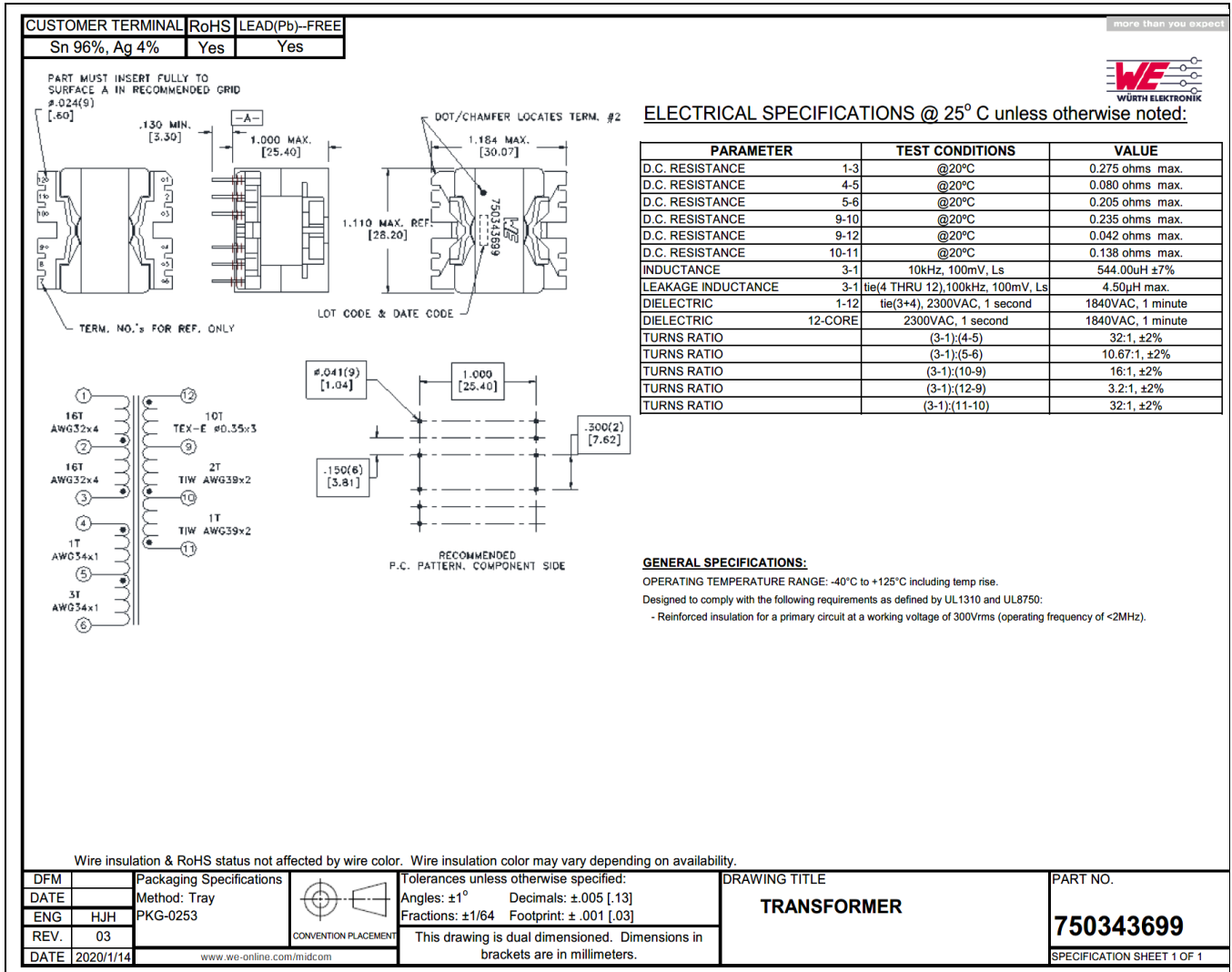

Figure 28 Flyback transformer (T1) specifications

7 References

- [1] XDPL8219 datasheet
- [2] XDPL8219 design guide

Revision history

8 Revision history

Document version	Date of release	Description of changes
V 1.0	2020-07-13	Initial version
V 1.1	2020-07-24	Section 5.9: Correction of text from “.. logic level of low = 1 and high = 0 , ..” to “..logic level of low = 0 and high = 1 ,..”.

Trademarks

All referenced product or service names and trademarks are the property of their respective owners.

Edition 2020-07-24

Published by

Infineon Technologies AG

81726 Munich, Germany

© 2020 Infineon Technologies AG.

All Rights Reserved.

Do you have a question about this document?

Email: erratum@infineon.com

Document reference

ER_2005_PL21_2006_125520

IMPORTANT NOTICE

The information contained in this application note is given as a hint for the implementation of the product only and shall in no event be regarded as a description or warranty of a certain functionality, condition or quality of the product. Before implementation of the product, the recipient of this application note must verify any function and other technical information given herein in the real application. Infineon Technologies hereby disclaims any and all warranties and liabilities of any kind (including without limitation warranties of non-infringement of intellectual property rights of any third party) with respect to any and all information given in this application note.

The data contained in this document is exclusively intended for technically trained staff. It is the responsibility of customer's technical departments to evaluate the suitability of the product for the intended application and the completeness of the product information given in this document with respect to such application.

For further information on the product, technology, delivery terms and conditions and prices please contact your nearest Infineon Technologies office (www.infineon.com).

WARNINGS

Due to technical requirements products may contain dangerous substances. For information on the types in question please contact your nearest Infineon Technologies office.

Except as otherwise explicitly approved by Infineon Technologies in a written document signed by authorized representatives of Infineon Technologies, Infineon Technologies' products may not be used in any applications where a failure of the product or any consequences of the use thereof can reasonably be expected to result in personal injury.