



EV3398H-S-00A

4-String, Max 400mA/String, 80V Return, Step-Up WLED Controller Evaluation Board

DESCRIPTION

The EV3398H-S-00A evaluation board is designed to demonstrate the capabilities of the MP3398H, a step-up controller with four LED current channels, designed to drive WLED arrays for large-sized LCD panel backlighting applications.

The MP3398H can expand the number of LED current channels with two or more ICs in parallel sharing a single power source.

The MP3398H employs peak current control mode with a fixed switching frequency (f_{sw}) that is configurable via an external setting resistor. The MP3398H drives an external MOSFET to boost the output voltage (V_{OUT}) from a 4.5V to 33V input voltage (V_{IN}) supply. The device also regulates the current in each LED string to the value set by an external current-setting resistor.

The MP3398H applies four internal current sources for current balancing. It achieves 1.5% current matching regulation accuracy between the strings. The low regulation voltage on the LED current sources reduces power loss.

The MP3398H supports direct pulse-width modulation (PWM) dimming mode with a PWM input and analog dimming mode with a PWM input or DC input. Full protection features include over-current protection (OCP), over-temperature protection (OTP), under-voltage protection (UVP), over-voltage protection (OVP), LED short and open protection, and inductor and diode short protection.

The MP3398H is available in a SOIC-16 package. The EV3398H-S-00A is a fully assembled evaluation board.

PERFORMANCE SUMMARY

Specifications are at $T_A = 25^\circ\text{C}$, unless otherwise noted.

Parameters	Conditions	Value
Input voltage (V_{IN}) range		13V to 33V
LEDs		4 LED strings, 20 LEDs/string
LED current (I_{LED})	$R_{ISET} = 10\text{k}\Omega$	120mA/string

EV3398H-S-00A EVALUATION BOARD



Top Layer

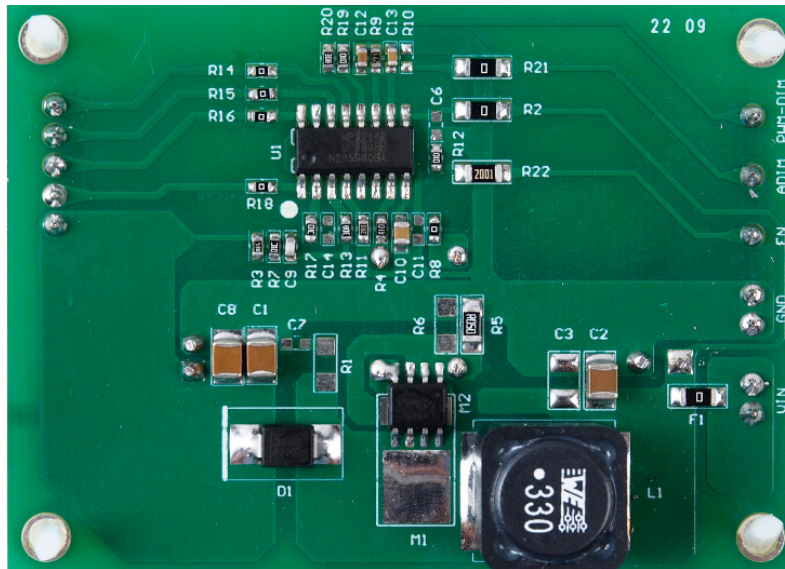

Bottom Layer
LxWxH (6.8cmx4.9cmx2cm)

Board Number	MPS IC Number
EV3398H-S-00A	MP3398HGS

QUICK START GUIDE

1. Connect the LED (4 strings) load terminals to:
 - a. Positive (+): LED+ terminal
 - b. Negative (-): LED1, LED2, LED3, and LED4 terminals
2. Connect the power supply (13V to 33V) terminals to:
 - a. Positive (+): VIN
 - b. Negative (-): GND
3. For direct pulse-width modulation (PWM) dimming, pull the ADIM pin high to VCC, then apply a PWM signal with a minimum voltage below 0.4V and a maximum voltage above 1.5V on the PWM pin. The PWM signal frequency is recommended to be between 200Hz to 2kHz.
4. For PWM input analog dimming, connect a ceramic capacitor between ADIM and GND, then apply a PWM signal with a minimum voltage below 0.4V and a maximum voltage above 1.5V on PWM. A frequency exceeding 20kHz is recommended to achieve improved PWM signal filtering performance.
5. For DC input analog dimming, pull PWM high to VCC or pull PWM down to GND, then apply a 0V to 1.5V DC voltage on ADIM to adjust the LED current (I_{LED}) amplitude from 0% to 100%.
6. Drive the EN pin high to 5V to enable the MP3398H.

EVALUATION BOARD SCHEMATIC

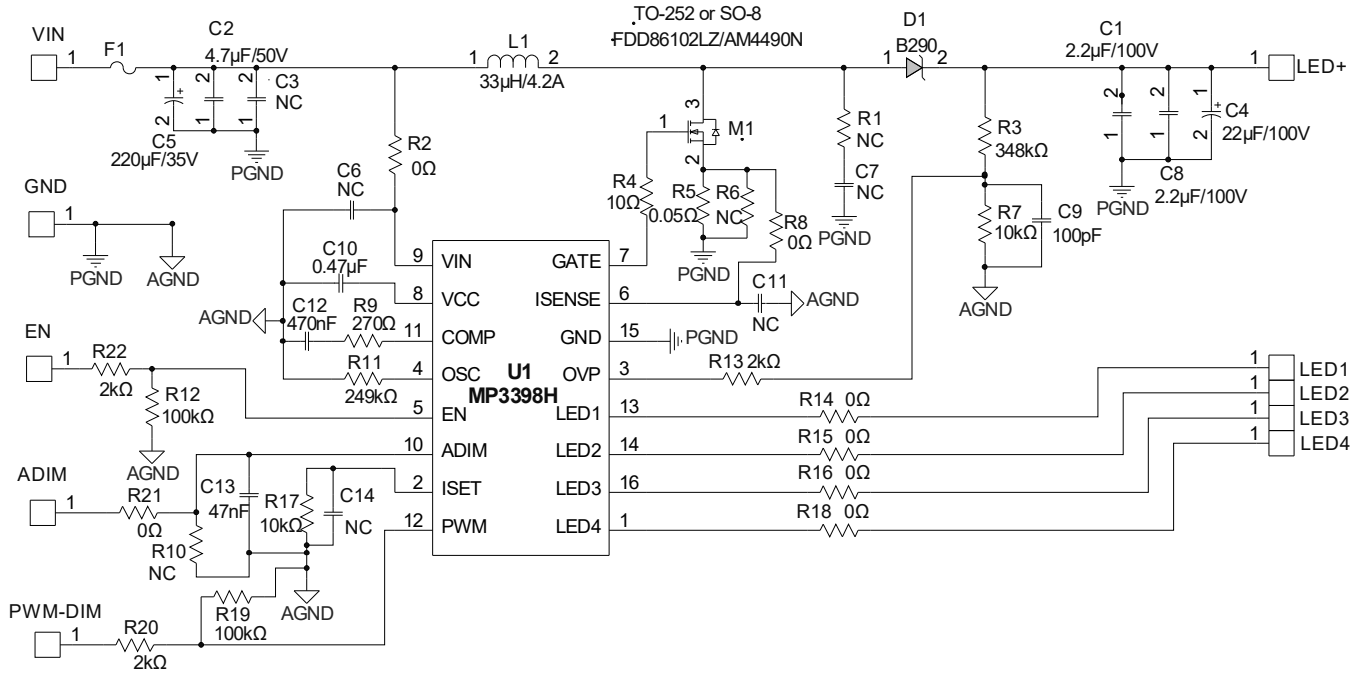

Figure 1: Evaluation Board Schematic

EV3398H-S-00A BILL OF MATERIALS

Qty	Ref	Value	Description	Package	Manufacturer	Manufacturer PN
1	C5	220 μ F	Electrolytic capacitor, 35V	DIP	Jianghai	ECR1VPT221M-080011
2	C1, C8	2.2 μ F	Ceramic capacitor, 100V, X7R	1210	Murata	GRM32ER72A225KA35L
1	C2	4.7 μ F	Ceramic capacitor, 50V, X7R	1210	Murata	GRM32ER71H475KA88L
1	C3	NC				
1	C4	22 μ F	Electrolytic capacitor, 100V	DIP	Jianghai	ECR2ABK220M-080011
4	C6, C7, C11, C14	NC				
1	C9	100pF	Ceramic capacitor, 50V, COG	0603	Murata	GRM1885C1H101JA01D
1	C13	47nF	Ceramic capacitor, 50V, X7R	0603	Murata	GCM188R71H473KA55D
1	C10	470nF	Ceramic capacitor, 16V, X7R	0805	Murata	GRM219R71C474KA01D
1	C12	470nF	Ceramic capacitor, 16V, X7R	0603	Murata	GRM188R71C474KA88D
1	D1	90V	Schottky diode, 2A	SMB	Diodes, Inc.	B290-13-F
1	F1	0 Ω	Film resistor, 1%	1206	Yageo	RC1206FR-070RL
1	L1	33 μ H	Inductor, 4.2A, 45m Ω	SMD	Würth	7447709330
1	M1	100V	N-channel MOSFET, 5.2A	SO-8	Analog Power	AM4490N-T1-PF
1	R10	NC				
1	R1	NC				
1	R3	348k Ω	Film resistor, 1%	0603	Yageo	RC0603FR-07348KL
1	R4	10 Ω	Film resistor, 1%	0603	Yageo	RC0603FR-0710RL
2	R7, R17	10k Ω	Film resistor, 1%	0603	Yageo	RC0603FR-0710KL
5	R8, R14, R15, R16, R18	0 Ω	Film resistor, 1%	0603	Yageo	RC0603JR-070RL
2	R2, R21	0 Ω	Film resistor, 1%	1206	Yageo	RC1206FR-070RL
1	R9	270 Ω	Film resistor, 1%	0603	Yageo	RC0603FR-07270RL
1	R5	0.05 Ω	Current sense resistor, 1%	1206	Panasonic	ERJ8CWFR050V
1	R6	NC				
2	R13, R20	2k Ω	Film resistor, 1%	0603	Yageo	RC0603FR-072KL
1	R22	2k Ω	Film resistor, 1%	1206	Yageo	RC1206FR-072KL
2	R12, R19	100k Ω	Film resistor, 1%	0603	Yageo	RC0603FR-07100KL
1	R11	249k Ω	Film resistor, 1%	0603	Yageo	RC0603FR-07249KL

EV3398H-S-00A BILL OF MATERIALS (continued)

Qty	Ref	Value	Description	Package	Manufacturer	Manufacturer PN
10	VIN, GND, EN, ADIM, PWM-DIM, LED+, LED1, LED2, LED3, LED4	2.54mm	Header connector, 90°	Any	Any	
1	U1	MP3398H	4-string, max 400mA/string, step-up WLED controller	SOIC-16	MPS	MP3398HGS

EVB TEST RESULTS

Performance waveforms are tested on the evaluation board. $V_{IN} = 19V$, $V_{EN} = 3.3V$, 120mA/string, 4 strings, 20 LEDs in series, $T_A = 25^{\circ}C$, unless otherwise noted.

Steady State

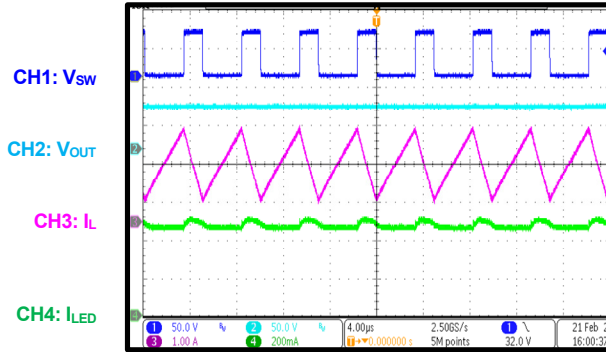

Start-Up through VIN

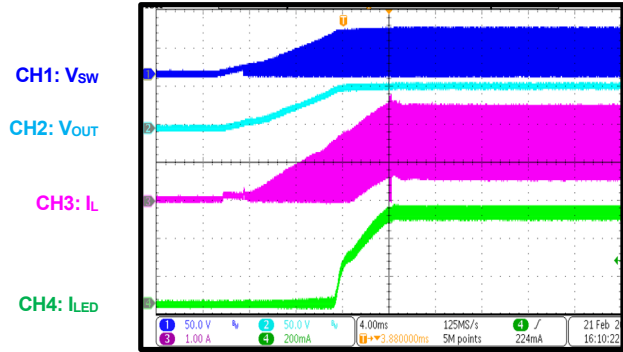

Start-Up through EN

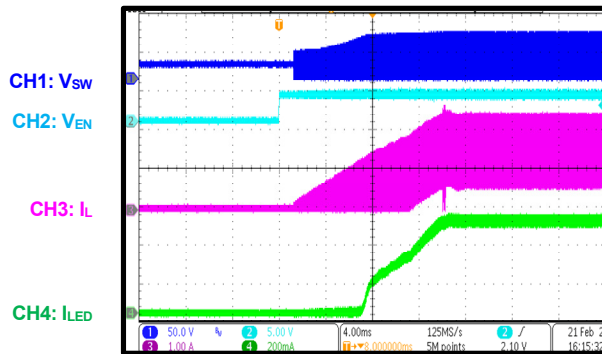

PWM Dimming

$f_{PWM} = 200Hz$, $D_{PWM} = 50\%$

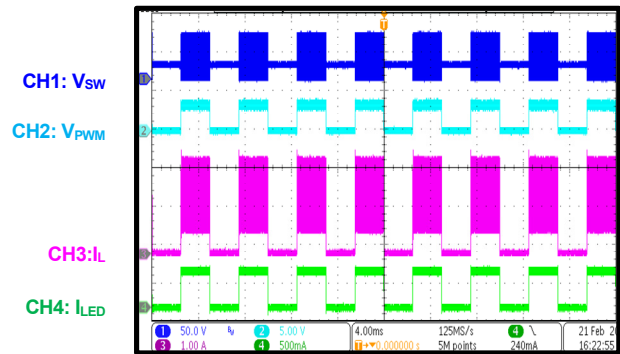

Analog Dimming with PWM Input

$f_{PWM} = 20kHz$, $D_{PWM} = 50\%$

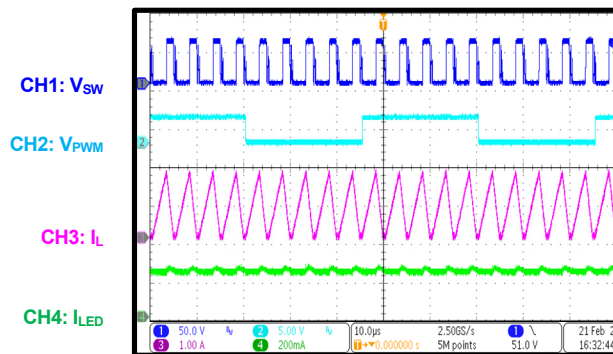

Analog Dimming with DC Input

$V_{ADIM} = 0.75V$

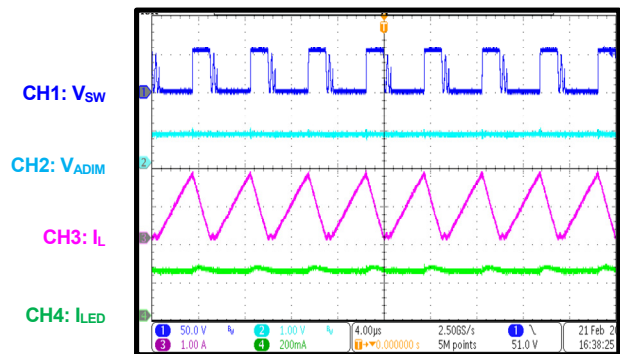

EVB TEST RESULTS (continued)

Performance waveforms are tested on the evaluation board. $V_{IN} = 19V$, $V_{EN} = 3.3V$, 120mA/string, 4 strings, 20 LEDs in series, $T_A = 25^{\circ}C$, unless otherwise noted.

LED Open Protection

Open one LED string during operation

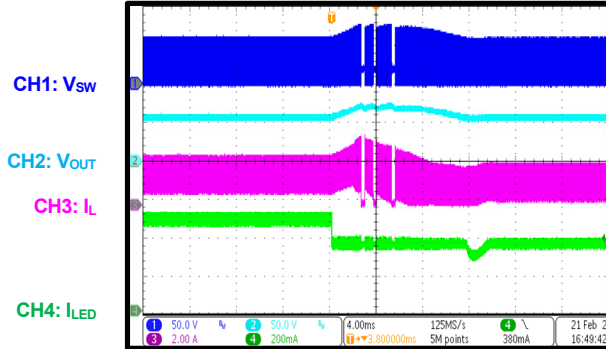

LED Short Protection

Short one LED string during operation

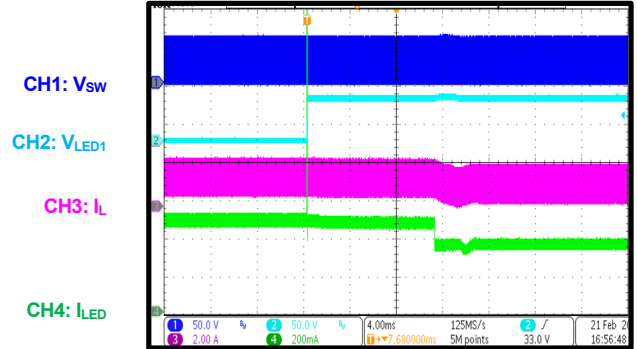

Inductor Short Protection

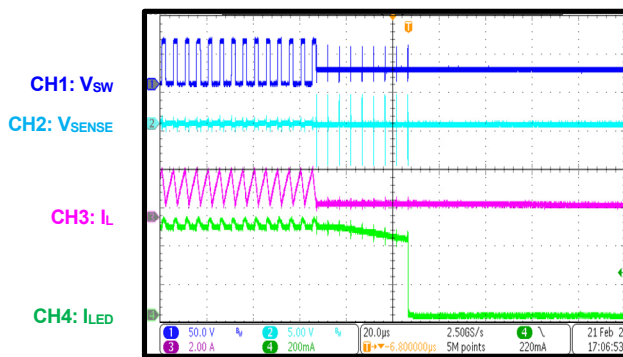

Diode Short Protection

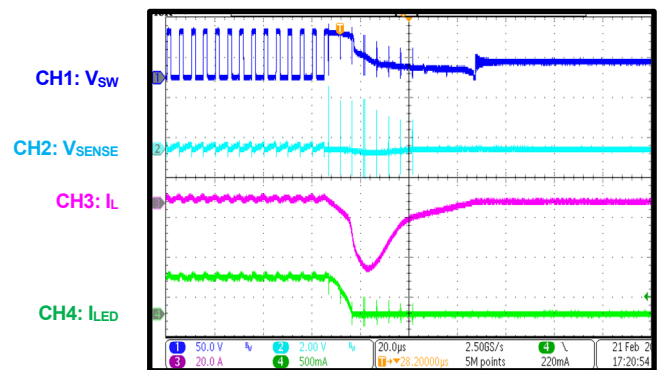

Over-Temperature Protection

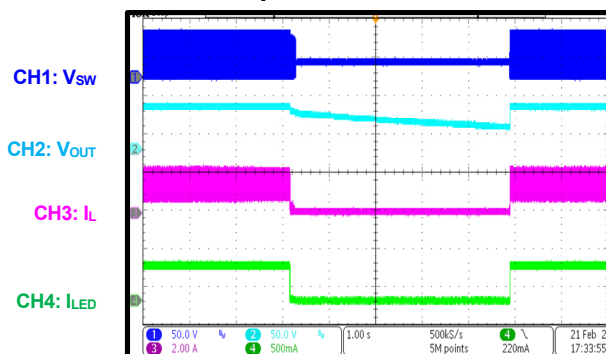

PCB LAYOUT

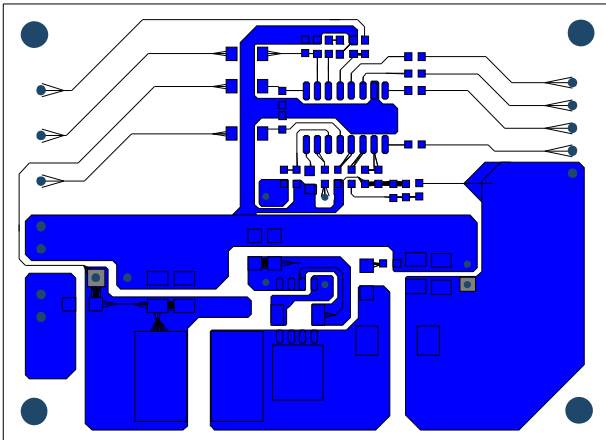

Figure 2: Bottom Layer



REVISION HISTORY

Revision #	Revision Date	Description	Pages Updated
1.0	8/25/2022	Initial Release	-

Notice: The information in this document is subject to change without notice. Please contact MPS for current specifications. Users should warrant and guarantee that third-party Intellectual Property rights are not infringed upon when integrating MPS products into any application. MPS will not assume any legal responsibility for any said applications.