



# Q2XAF Mechanically Adjustable Background Suppression Sensor Product Manual

Original Instructions

p/n: 217279 Rev. F

07-Nov-25

© Banner Engineering Corp. All rights reserved. [www.bannerengineering.com](http://www.bannerengineering.com)

# Contents

<b>Chapter 1 Features</b> .....	<b>3</b>
Models .....	3
Overview .....	4
<b>Chapter 2 Installation</b> .....	<b>5</b>
Sensor Orientation .....	5
Tilt the Sensor for Shiny Targets .....	5
Mount the Device .....	5
Wiring .....	6
<b>Chapter 3 Sensor Setup - Background Suppression</b> .....	<b>7</b>
Setup Example .....	7
<b>Chapter 4 Specifications</b> .....	<b>9</b>
Dimensions .....	10
Performance Curves .....	10
Q2XAF Excess Gain Curves .....	11
Class 1 Laser Description and Safety Information .....	12
<b>Chapter 5 Accessories</b> .....	<b>13</b>
Cordsets .....	13
Brackets .....	14
<b>Chapter 6 Product Support and Maintenance</b> .....	<b>16</b>
Clean with Mild Detergent and Warm Water .....	16
Repairs .....	16
Contact Us .....	16
Banner Engineering Corp Limited Warranty .....	16

Chapter Contents

Models ..... 3  
 Overview ..... 4

# Chapter 1 Features



- Compact sensor for installation in the smallest of spaces
- Exceptional optical performance; up to 150 mm sensing range in compact Q2X housing
- Background suppression models for reliable detection of objects when the background condition is not controlled or fixed
- Simple multi-turn screw adjustment of cutoff distance
- Enhanced immunity to fluorescent lights
- Crosstalk immunity algorithm allows two sensors to be used in close proximity
- Small visible red LED or Class 1 laser emitter spot

**WARNING:**



- **Do not use this device for personnel protection**
- Using this device for personnel protection could result in serious injury or death.
- This device does not include the self-checking redundant circuitry necessary to allow its use in personnel safety applications. A device failure or malfunction can cause either an energized (on) or de-energized (off) output condition.

## Models

Sensing Mode	Models	Sensing Range	Connection	Output Type
Adjustable Field, Visible red, 645 nm	Q2XAPAF150-2M	Adjustable Cutoff: 18 mm to 150 mm Minimum sensing range: < 1.6 mm depending on cutoff and target reflectivity	2 m (6.5 ft) unterminated 3-wire PVC-jacketed cable	1 PNP Light Operate (LO)
	Q2XANAF150-2M			1 NPN LO
	Q2XABAF150-Q		150 mm (6 in) PVC-jacketed cable with a 4-pin M8 male quick-disconnect connector	Bipolar LO
Adjustable Field, Visible red Class 1 laser, 680 nm	Q2XAPLAF100-2M	Adjustable Cutoff: 18 mm to 100 mm Minimum sensing range: < 1.6 mm depending on cutoff and target reflectivity	2 m (6.5 ft) unterminated 3-wire PVC-jacketed cable	1 PNP LO
	Q2XANLAF100-2M			1 NPN LO
	Q2XABLAF100-Q		150 mm (6 in) PVC-jacketed cable with a 4-pin M8 male quick-disconnect connector	Bipolar LO

- To order Dark Operate (DO) models, replace "AP", "AN", or "AB" with "RP", "RN", or "RB", respectively.
- To order PNP or NPN models with a 150 mm (6 in) PVC cable and a 3-pin M8 male quick disconnect, replace "-2M" with "-Q3".
- To order Bipolar models with a 150 mm (6 in) PVC cable and a 4-pin M12 male quick disconnect, replace "-Q" with "-Q5".

## Overview

Q2X Adjustable-Field Sensors with Background Suppression ignore objects beyond the set cutoff distance. Background suppression mode can be used in most situations with varying object color and position or with varying background conditions.

*Sensor features*

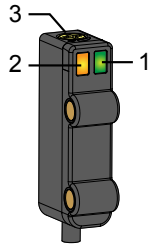

1. Green: Power Indicator
2. Yellow: Light Sensed Indicator (Flashes for Marginal Conditions)
3. Cutoff Point Adjustment Screw

Chapter Contents

Sensor Orientation .....	5
Tilt the Sensor for Shiny Targets .....	5
Mount the Device .....	5
Wiring .....	6

## Chapter 2 Installation

### Sensor Orientation

To ensure reliable detection, orient the sensor as shown in relation to the target to be detected.

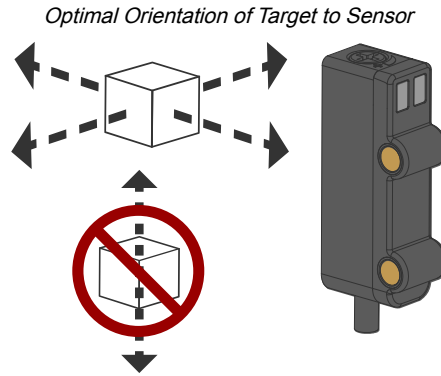

### Tilt the Sensor for Shiny Targets

To detect shiny targets, like unfinished metal, tilt the sensor 5° to 15°. The orientation of the sensor is important. Angle the connector up, so the specular reflection bounces away from the receiver.

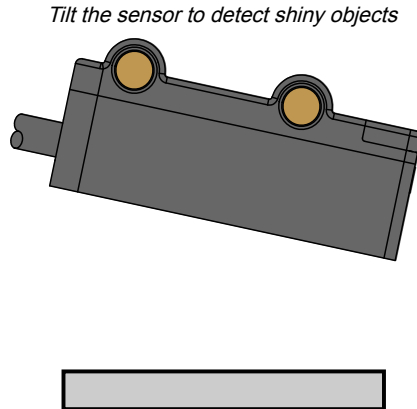

### Mount the Device

1. If a bracket is needed, mount the device onto the bracket.
2. Mount the device (or the device and the bracket) to the machine or equipment at the desired location. Do not tighten the mounting screws at this time.
3. Check the device alignment.
4. Tighten the mounting screws to secure the device (or the device and the bracket) in the aligned position.

# Wiring

Cabled wiring diagrams are shown. Quick disconnect wiring diagrams are functionally identical.

 **CAUTION:** Observe proper ESD precautions (grounding) when connecting quick disconnect models.

**Bipolar Models, Light Operate**

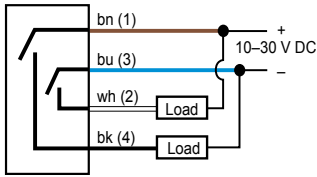

**PNP Models, Light Operate**

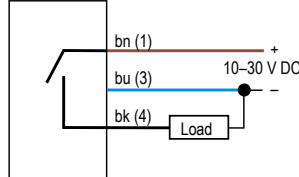

**NPN Models, Light Operate**

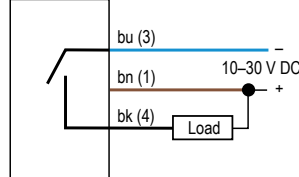

**Bipolar Models, Dark Operate**

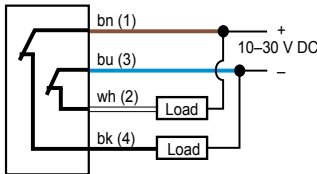

**PNP Models, Dark Operate**

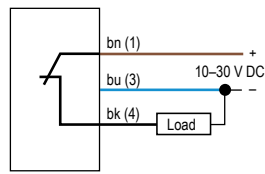

**NPN Models, Dark Operate**

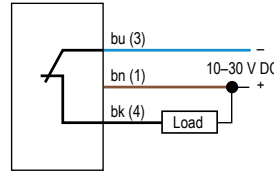

**4-pin M8 Male Quick Disconnect**

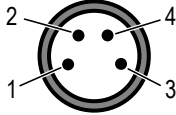

**3-pin M8 Male Quick Disconnect**



**4-pin M12 Male Quick Disconnect**

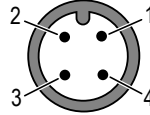

**Key**

- 1 = Brown
- 2 = White
- 3 = Blue
- 4 = Black

In dark operate (DO) mode, the output is ON when the target returns less light to the sensor than the configured target and OFF when the sensor detects more light than the configured/taught target.

In light operate (LO) mode, the output is ON when the target returns the same or more light to the sensor and OFF when the sensor detects less light than the configured/taught target.

In **adjustable field** sensing modes, light operate is active when the target is present and dark operate is active when the target is absent.

## Chapter Contents

Setup Example ..... 7

## Chapter 3 Sensor Setup - Background Suppression

**Background Suppression Mode:** Detect objects closer than the set cutoff distance. Ignore objects more than the minimum separation distance and further than the set cutoff distance.

To ensure reliable background suppression, a minimum separation distance between the object to be detected and the background to be ignored is necessary. See Minimum Separation Distance in "[Q2XAF Performance Curves](#)" on page 10 to determine the minimum separation distance for the sensor's emitter type: LED or laser.

1. Mount the sensor with the darkest object at the longest application distance. The distance to the object must be less than shown in the Minimum Separation Distance figure in "[Q2XAF Performance Curves](#)" on page 10 for your object color.
2. Turn the adjustment potentiometer **counter-clockwise** until the yellow indicator turns **off** (3 turns maximum).
3. Turn the adjustment potentiometer **clockwise** until the yellow indicator turns **on**.
4. Replace the darkest object with the brightest background at the closest application distance.
5. Turn the adjustment potentiometer **clockwise**, counting the revolutions, until the yellow indicator turns **on**.
  - a. **Application Note:** If the background turns the sensor **on** before adjusting the potentiometer, the object-to-background distance is too close for reliable operation, and the Minimum Separation Distance is not met.
6. Turn the adjustment potentiometer **counter-clockwise** half of the number of turns from step 5. This places the cutoff distance midway between the object and the background switchpoints (see [Set the cutoff distance approximately midway between the farthest object and the closest background](#)). The sensor is ready for operation.

*Set the cutoff distance approximately midway between the farthest object and the closest background*

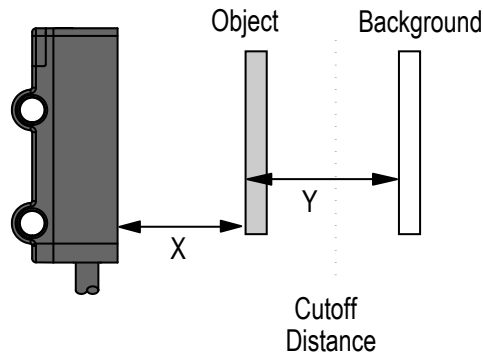

X: Distance to the Object

Y: Minimum Separation Between the Object and the Background

### Setup Example

An object with a reflectivity similar to black paper is set 75 mm away from the sensor. A background with a reflectivity similar to white paper is set 90 mm away from the sensor. According to the Minimum Separation Distance figure in "[Q2XAF Performance Curves](#)" on page 10, the LED sensor requires a minimum separation distance of 4 mm between the object and the background for reliable operation, and the laser sensor requires a minimum separation distance of 10 mm. In this application, reliable detection for both sensor types is achieved when set up according to the procedure outlined in "[Sensor Setup - Background Suppression](#)" on page 7.

**Application Notes:** Laser sensors can be influenced by the lateral motion of some objects as they laterally pass by the sensor as shown in [Background Suppression Mode Application Example](#). If the object causes output instability when moving past the sensor laterally, move the sensor closer to the object or turn the adjustment potentiometer clockwise to slightly move the cutoff distance further past the object to stabilize the output.

*Background Suppression Mode Application Example*

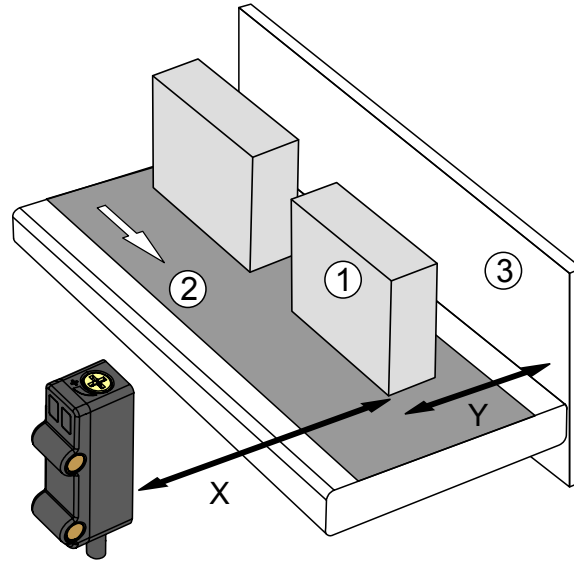

- 1. Object
- 2. Conveyor
- 3. Background
- X: Distance to the Object = 75 mm
- Y: Minimum Separation Between the Object and the Background > 4 mm or 10 mm, depending on the sensor type



Chapter Contents

Dimensions..... 10  
 Performance Curves ..... 10  
 Q2XAF Excess Gain Curves ..... 11  
 Class 1 Laser Description and Safety Information ..... 12

# Chapter 4 Specifications

**Supply Voltage**

10 V DC to 30 V DC (10% maximum ripple within specified limits) at less than 16 mA, exclusive of load

**Sensing Beam**

Q2XAF150 (LED): Visible red LED, 645 nm  
 Q2XLAF100 (Laser): Visible red (see "Class 1 Laser Description and Safety Information" on page 12)

**Supply Protection Circuitry**

Protected against reverse polarity and transient voltages

**Output Configuration**

Bipolar (1 NPN and 1 PNP) solid-state output or single output (PNP or NPN), light operate (LO) or dark operate (DO), depending on model  
 Rating: 50 mA total output current  
**Off-state leakage current:** < 10 µA at 30 V DC  
**ON-state saturation voltage:** < 2 V at 50 mA  
 Protected against output short-circuit, continuous overload, and false pulse on power-up

**Connections**

2 m (6.5 ft) unterminated 3-wire PVC-jacketed cable, 150 mm (6 in) PVC-jacketed cable with a 3-pin M8 male quick-disconnect connector, 150 mm (6 in) PVC-jacketed cable with a 4-pin M8 male quick-disconnect connector, or 150 mm (6 in) PVC-jacketed cable with a 4-pin M12 male quick-disconnect connector, depending on model.

**Environmental Rating**

IP67

**Operating Conditions**

95% at +50 °C maximum relative humidity (non-condensing)  
 Temperature: -25 °C to +50 °C (-13 °F to +122 °F)

**Application Notes**

For mirror-like objects, minimize the sensor-to-object mounting distance and tilt the sensor so reflected light is directed away from the sensor when the object is present

**Certifications**

 Banner Engineering BV  
 Park Lane, Culliganlaan 2F bus 3  
 1831 Diegem, BELGIUM

 Turck Banner LTD Blenheim House  
 Blenheim Court  
 Wickford, Essex SS11 8YT  
 GREAT BRITAIN

 Industrial Control Equipment  
 LISTED 3TJJ

**Construction**

PC/ABS housing, acrylic lens cover; PVC cable, acetal adjustment potentiometer

**Output Response**

850 microseconds, OFF to ON and ON to OFF  
**Note:** 120-millisecond delay on power-up; outputs do not conduct during this time

**Adjustments**

Three-turn adjustment potentiometer sets the cutoff distance between minimum and maximum positions, clutched at both ends of travel

**Repeatability**

125 µs

**Indicators**

Two LED indicators on sensor top:  
 Green solid: Power on  
 Amber solid: Light sensed  
 Amber flashing: Marginal sensing condition

**Required Overcurrent Protection**

 **WARNING:** Electrical connections must be made by qualified personnel in accordance with local and national electrical codes and regulations.

Overcurrent protection is required to be provided by end product application per the supplied table.

Overcurrent protection may be provided with external fusing or via Current Limiting, Class 2 Power Supply.

Supply wiring leads < 24 AWG shall not be spliced.

For additional product support, go to [www.bannerengineering.com](http://www.bannerengineering.com).

Supply Wiring (AWG)	Required Overcurrent Protection (A)	Supply Wiring (AWG)	Required Overcurrent Protection (A)
20	5.0	26	1.0
22	3.0	28	0.8
24	2.0	30	0.5

## Dimensions

All measurements are listed in millimeters [inches], unless noted otherwise. The measurements provided are subject to change.

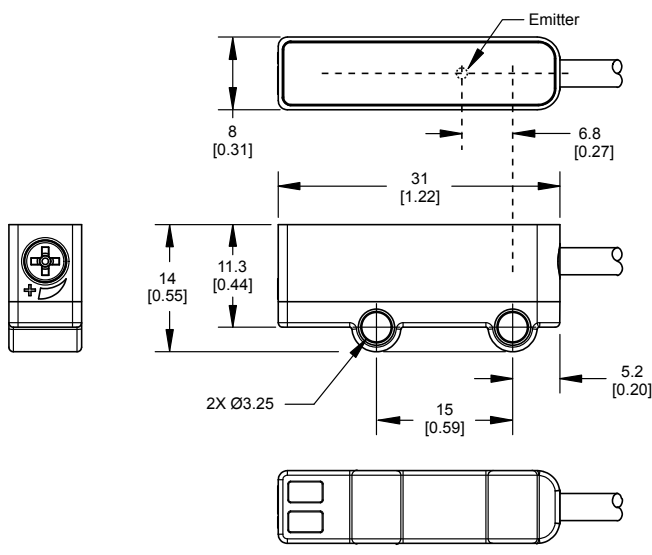

- Hardware Included:  
 (2) M3 x 0.5 x 16 mm SS screw  
 (2) M3 x 0.5 SS nut  
 (2) M3 flat SS washer  
 (2) M3 internal tooth SS lockwasher

Maximum torque 0.9 Nm (8 in-lbf)

## Performance Curves

Q2XAF150 (LED) Static Minimum Separation Distance Between Object and Background:  
Background Suppression Mode

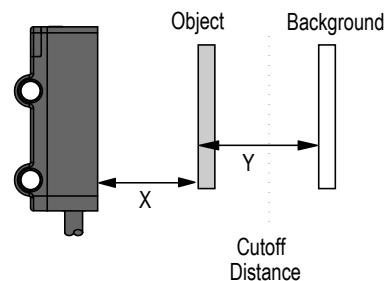
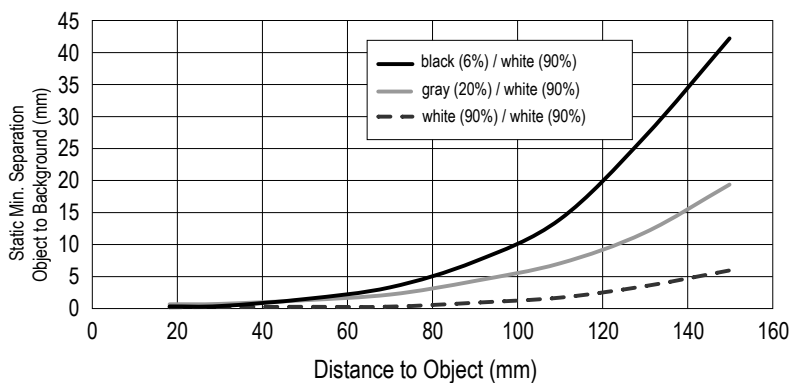

X: Distance to Object (mm)

Y: Minimum Separation Between Object and Background (mm)

Continued on page 11

Continued from page 10

*Q2XLAF100 (Laser) Static Minimum Separation Distance Between Object and Background:  
Background Suppression Mode*

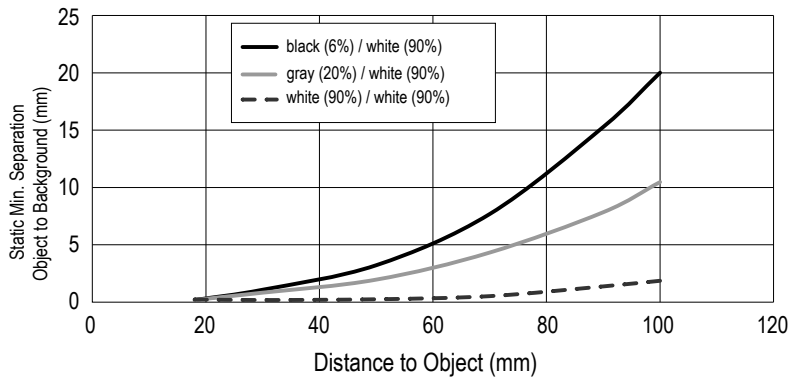

*Q2XAF150 (LED) Typical Emitter Spot Diameter vs. Distance*

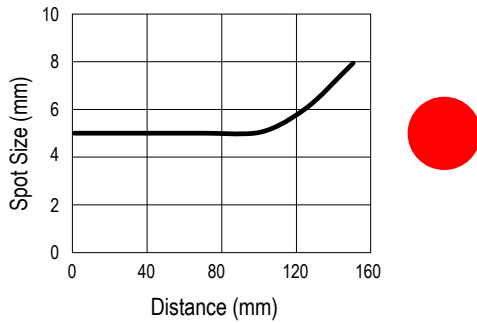

*Q2XLAF100 (Laser) Typical Emitter Spot Diameter vs. Distance*

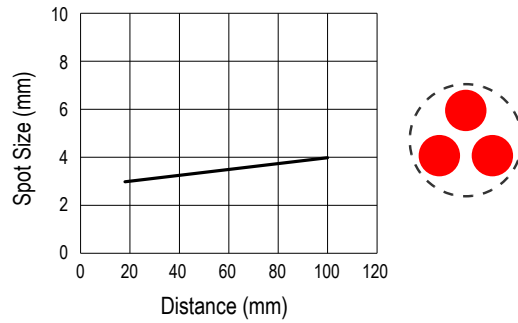

## Q2XAF Excess Gain Curves

*Q2XAF150 (LED) Excess Gain Curve with 18 mm Cutoff and 150 mm Cutoff (based on 90% White Card)*

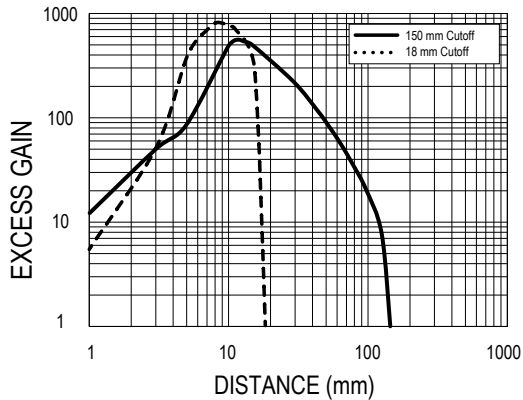

*Q2XLAF100 (Laser) Excess Gain Curve with 18 mm Cutoff and 100 mm Cutoff (based on 90% White Card)*

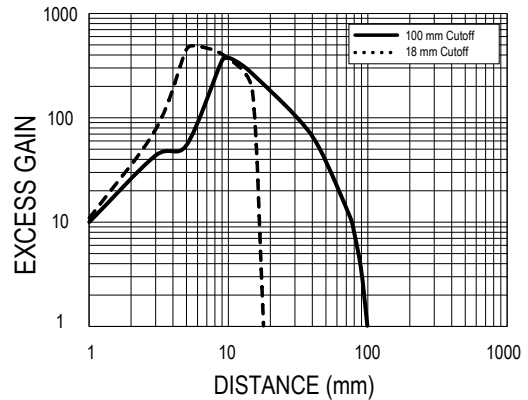

## Class 1 Laser Description and Safety Information



**Laser light. Do not stare into the beam.**

Complies with 21 CFR 1040.10 and 1040.11 except for deviations pursuant to Laser Notice No. 56, dated May 8, 2019.

**CLASS 1  
LASER PRODUCT**

### CAUTION:



- **Never stare directly into the sensor lens.**
- Laser light can damage your eyes.
- Avoid placing any mirror-like object in the beam. Never use a mirror as a retroreflective target.

### CAUTION:



- **Return defective units to the manufacturer.**
- Use of controls or adjustments or performance of procedures other than those specified herein may result in hazardous radiation exposure.
- Do not attempt to disassemble this sensor for repair. A defective unit must be returned to the manufacturer.

### CAUTION:



- **Ne regardez jamais directement la lentille du capteur.**
- La lumière laser peut endommager la vision.
- Évitez de placer un objet réfléchissant (de type miroir) dans la trajectoire du faisceau. N'utilisez jamais de miroir comme cible rétro-réfléchissante.

### CAUTION:



- **Tout dispositif défectueux doit être renvoyé au fabricant.**
- L'utilisation de commandes, de réglages ou de procédures autres que celles décrites dans le présent document peut entraîner une exposition dangereuse aux radiations.
- N'essayez pas de démonter ce capteur pour le réparer. Tout dispositif défectueux doit être renvoyé au fabricant.

Class 1 lasers are lasers that are safe under reasonably foreseeable conditions of operation, including the use of optical instruments for intrabeam viewing.

Complies with IEC 60825-1:2014 and EN 60825-1:2014+A11:2021.

### For safe laser use:

- Do not stare at the laser.
- Do not point the laser at a person's eye.
- Mount open laser beam paths either above or below eye level, where practical.
- Terminate the beam emitted by the laser product at the end of its useful path.

### Class 1 Laser Characteristics

Output power: 0.25 mW  
Laser wavelength: 680 nm  
Pulse duration: 87  $\mu$ s

Chapter Contents

Cordsets ..... 13  
 Brackets ..... 14

# Chapter 5 Accessories

## Cordsets

3-pin Single-Ended M8 Female Cordsets (datasheet p/n 236620)				
Model	Length	Dimensions (mm)	Pinout (Female)	
BC-M8F3-24-0.5	0.5 m (1.64 ft)			1 = Brown 3 = Blue 4 = Black 
BC-M8F3-24-1	1 m (3.28 ft)			
BC-M8F3-24-2	2 m (6.56 ft)			
BC-M8F3-24-5	5 m (16.4 ft)			
BC-M8F3-24-8	8 m (26.25 ft)			
BC-M8F3-24-10	10 m (30.81 ft)			

4-pin Single-Ended M8 Female Cordsets (datasheet p/n 236623)				
Model	Length	Dimensions (mm)	Pinout (Female)	
BC-M8F4-24-0.5	0.5 m (1.64 ft)			1 = Brown 2 = White 3 = Blue 4 = Black 
BC-M8F4-24-1	1 m (3.28 ft)			
BC-M8F4-24-2	2 m (6.56 ft)			
BC-M8F4-24-5	5 m (16.4 ft)			
BC-M8F4-24-8	8 m (26.25 ft)			
BC-M8F4-24-10	10 m (30.81 ft)			

4-pin Single-Ended M12 Female Cordsets (datasheet p/n 235937)				
Model	Length	Dimensions (mm)	Pinout (Female)	
BC-M12F4-22-1	1 m (3.28 ft)			1 = Brown 2 = White 3 = Blue 4 = Black 5 = Unused 
BC-M12F4-22-2	2 m (6.56 ft)			
BC-M12F4-22-5	5 m (16.4 ft)			
BC-M12F4-22-8	8 m (26.25 ft)			
BC-M12F4-22-10	10 m (30.81 ft)			
BC-M12F4-22-15	15 m (49.2 ft)			
BC-M12F4-22-20	20 m (65.61 ft)			
BC-M12F4-22-25	25 m (82.02 ft)			
BC-M12F4-22-30	30 m (98.42 ft)			

4-pin Single-Ended M12 Female Right-Angle Cordsets (datasheet p/n <a href="#">235937</a> )				
Model	Length	Dimensions (mm)		Pinout (Female)
BC-M12F4A-22-1	1 m (3.28 ft)			<p>1 = Brown 2 = White 3 = Blue 4 = Black 5 = Unused</p>
BC-M12F4A-22-2	2 m (6.56 ft)			
BC-M12F4A-22-5	5 m (16.4 ft)			
BC-M12F4A-22-8	8 m (26.25 ft)			
BC-M12F4A-22-10	10 m (30.81 ft)			
BC-M12F4A-22-15	15 m (49.2 ft)			

## Brackets

All measurements are listed in millimeters, unless noted otherwise. The measurements provided are subject to change.

<p><b>SMBQ2XA</b></p> <ul style="list-style-type: none"> <li>• Vertical L-shaped bracket</li> <li>• 20-ga stainless steel</li> </ul>	
<p><b>SMBQ2XB</b></p> <ul style="list-style-type: none"> <li>• Rear L-shaped bracket</li> <li>• 20-ga stainless steel</li> </ul>	
<p><b>SMBQ20FA</b></p> <ul style="list-style-type: none"> <li>• Includes 3/8-16 × 2 in socket head cap screw (SHCS)</li> <li>• 304 stainless steel</li> </ul>	

**SMBQ20FAM10**

- Kit for 10 mm (3/8 in) Rod Bracket Systems for Q2X, Q20, Q12, VS1, VS3, VS8
- Includes M10-1.5 x 50 mm Socket Head Cap Screw (SHCS)

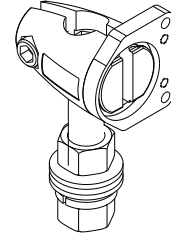
**SMBQ20FAM12**

- Kit for 12 mm (1/2 in) Rod Bracket Systems for Q2X, Q20, Q12, VS1, VS3, VS8
- No socket head cap screw (SHCS) included

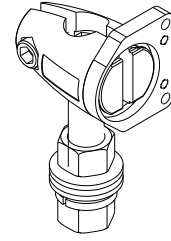

Chapter Contents

Clean with Mild Detergent and Warm Water ..... 16  
Repairs ..... 16  
Contact Us ..... 16  
Banner Engineering Corp Limited Warranty ..... 16

## Chapter 6 Product Support and Maintenance

### Clean with Mild Detergent and Warm Water

Handle the sensor with care during installation and operation. Sensor windows soiled by fingerprints, dust, water, oil, etc. create stray light that may degrade the peak performance of the sensor.

Wipe down the device with a soft cloth dampened with a mild detergent and warm water solution. Do not use any other chemicals for cleaning.

### Repairs

Contact Banner Engineering for troubleshooting of this device. **Do not attempt any repairs to this Banner device; it contains no field-replaceable parts or components.** If the device, device part, or device component is determined to be defective by a Banner Applications Engineer, they will advise you of Banner's RMA (Return Merchandise Authorization) procedure.

**IMPORTANT:** If instructed to return the device, pack it with care. Damage that occurs in return shipping is not covered by warranty.

### Contact Us

Banner Engineering Corp. | 9714 Tenth Avenue North | Plymouth, MN 55441, USA | Phone: + 1 888 373 6767

For worldwide locations and local representatives, visit [www.bannerengineering.com](http://www.bannerengineering.com).

### Banner Engineering Corp Limited Warranty

Banner Engineering Corp. warrants its products to be free from defects in material and workmanship for one year following the date of shipment. Banner Engineering Corp. will repair or replace, free of charge, any product of its manufacture which, at the time it is returned to the factory, is found to have been defective during the warranty period. This warranty does not cover damage or liability for misuse, abuse, or the improper application or installation of the Banner product.

**THIS LIMITED WARRANTY IS EXCLUSIVE AND IN LIEU OF ALL OTHER WARRANTIES WHETHER EXPRESS OR IMPLIED (INCLUDING, WITHOUT LIMITATION, ANY WARRANTY OF MERCHANTABILITY OR FITNESS FOR A PARTICULAR PURPOSE), AND WHETHER ARISING UNDER COURSE OF PERFORMANCE, COURSE OF DEALING OR TRADE USAGE.**

This Warranty is exclusive and limited to repair or, at the discretion of Banner Engineering Corp., replacement. **IN NO EVENT SHALL BANNER ENGINEERING CORP. BE LIABLE TO BUYER OR ANY OTHER PERSON OR ENTITY FOR ANY EXTRA COSTS, EXPENSES, LOSSES, LOSS OF PROFITS, OR ANY INCIDENTAL, CONSEQUENTIAL OR SPECIAL DAMAGES RESULTING FROM ANY PRODUCT DEFECT OR FROM THE USE OR INABILITY TO USE THE PRODUCT, WHETHER ARISING IN CONTRACT OR WARRANTY, STATUTE, TORT, STRICT LIABILITY, NEGLIGENCE, OR OTHERWISE.**

Banner Engineering Corp. reserves the right to change, modify or improve the design of the product without assuming any obligations or liabilities relating to any product previously manufactured by Banner Engineering Corp. Any misuse, abuse, or improper application or installation of this product or use of the product for personal protection applications when the product is identified as not intended for such purposes will void the product warranty. Any modifications to this product without prior express approval by Banner Engineering Corp will void the product warranties. All specifications published in this document are subject to change; Banner reserves the right to modify product specifications or update documentation at any time. Specifications and product information in English supersede that which is provided in any other language. For the most recent version of any documentation, refer to: [www.bannerengineering.com](http://www.bannerengineering.com).

For patent information, see [www.bannerengineering.com/patents](http://www.bannerengineering.com/patents).



