

8060 Series

Alternate Action and Momentary Pushbutton Switches

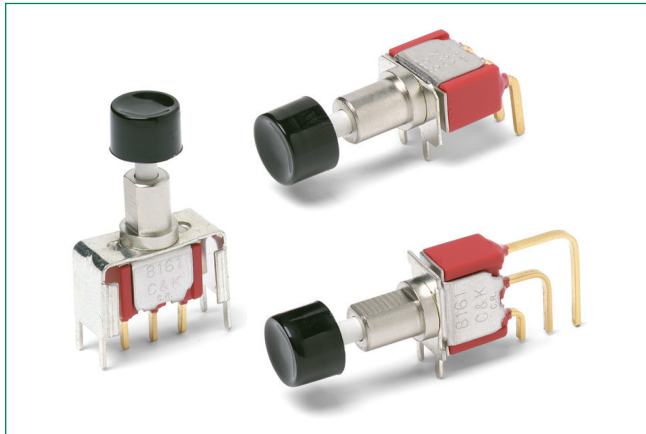

Agency Approvals

Agency	Agency File Number
UL US	E42363

Specifications

Contact Rating	Q contact material: 6 AMPS @ 120 V AC or 28 V DC; 3 AMPS @ 250 V AC. See page 10 for additional ratings.
Electrical Life	50,000 make-and-break cycles at full load.
Contact Resistance	Below 20 mΩ typ. initial @ 2-4 V DC, 100 mA, for both silver and gold plated contacts.
Insulation Resistance	10 ⁹ Ω min.
Dielectric Strength	1000 Vrms min. @ sea level.
Operating Temperature	-30°C to 65°C
Cap Installation Force	10 lbs. Max. permissible
Solderability	Per MIL-STD-202F method 208D, or EIA RS-186E method 9 (1 hour steam aging).

Notes:

Any models supplied with P, R, S, Q, B or G contact material are RoHS compliant. Specifications and materials listed above are for switches with standard options. For information on specific and custom switches, consult Customer Service Center.

Description

Leading telecommunications and networking equipment designers turn to C&K for its 8060 series alternate action and momentary pushbutton switches. 8060 switches are high-performing and long-lasting, are available with LEDs – and are epoxy terminal seal-compatible with bottom wash cleaning.

Features & Benefits

- Long travel
- Available with LED
- Long life contact design
- Epoxy terminal seal compatible with bottom wash cleaning
- RoHS compliant models available

Applications

- Instrumentation
- Computers and peripherals
- Telecommunications and networking equipment

Materials

Case	Glass filled nylon 6/6 or diallyl phthalate (DAP), flame retardant (UL 94V-0).
Plunger	S, S1, S2 Options: Glass filled nylon or glass filled polyester (PBT) (UL 94V-0). L, L1 Options: Brass, nickel plated.
Cap & Frame	Nylon, black, standard.
Bushing	Brass or zinc, nickel plated
Housing	Stainless Steel
Switch Support	Brass or steel, matte-tin plated.
End Contacts	Q contact material: Coin silver, silver plated. See page 10 for additional contact materials.
Center Contacts & All Terminals	Q contact material: Copper alloy, silver plated. See page 10 for additional contact materials.
Terminal Seal	Epoxy. Refer to soldering and cleaning Technical Data Chapter.
Hardware	Nut & Locking Ring: Brass, nickel plated; Lockwasher: Steel, nickel plated.

8060 Series

Alternate Action and Momentary Pushbutton Switches



Ordering Number

To order, simply select desired option from each category and place in the appropriate box. Available options are shown and described below. For additional options not shown in catalog, consult Customer Service Center. All models have epoxy terminal seal and are compatible with all "bottom-wash" PCB cleaning methods.

X - X - X - X - X - X - X - X - X - X

<p>Switch Function 8161: SPDT On-On 8168: SPDT On-Mom.</p> <p>Actuator or Plunger S: 0.710" high plunger with 0.375" dia. cap J80: Snap-in J81: Snap-in w/ frame J82: Snap-in w/ frame for LED J86: Snap-in w/ frame & LED L: 0.740" high plunger with 0.395" dia. cap L1: 0.740" high plunger with 0.590" dia. cap S1: 0.615" high plunger with 0.200" dia. cap S2: 0.710" high plunger with 0.310" dia. cap</p> <p>Bushing H: 0.300" high, flat, hi torque H9: 0.300" high, flat, hi torque NONE: No bushing choice required Y3: 7.6mm, keyway</p> <p>Terminations A: Right angle, PC Thru-hole AV2: Vertical right angle, PC Thru-hole C: PC Thru-hole Z: Solder lug A3: Vertical right angle, snap-in, PC Thru-hole</p>	<p>LED Color 3: Red None: Models without LED</p> <p>Frame Color 2: Black</p> <p>Cap Color 2: Black 4: Orange 1: White 5: Yellow 3: Red 9: Gray</p> <p>Seal E: Epoxy I: Epoxy potted base</p> <p>Contact Material B: Gold P: Gold, matte-tin Q: Silver S: Silver, matte-tin G: Gold over silver R: Gold over silver, matte tin</p>	<p>AV3: Vertical right angle, snap-in, PC thru-hole V3: 0.460" high, V-bracket V4: 0.630" high, V-bracket V6: 0.460" high, V-bracket</p> <p>V21: 0.555" high, snap-in V-bracket V31: 0.460" high, snap-in V-bracket W: 0.750" long, wire wrap Z3: Quick connect</p>
---	--	---

Switch Function SPDT

No. Poles	Mo. Poles	Switch Function		Connected Terminals		Schematic
		POS. 1	POS. 2	POS. 1	POS. 2	
		C&K marking this side				
SP	8161	ON	ON	2-3	2-1	
	8168	ON	MOM.	2-3	2-1	

Dimensions: inches(mm)

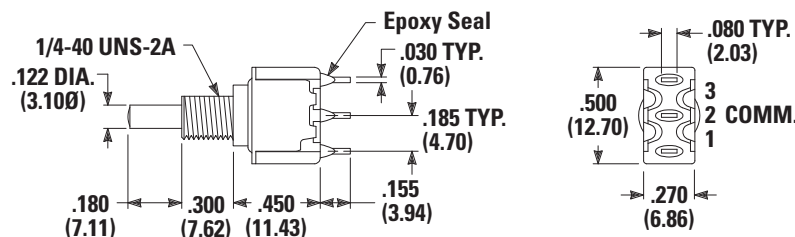

Part Number Shown: 8161SHZQE

Terminal Nos. For Reference Only

8060 Series

Alternate Action and Momentary Pushbutton Switches



DPDT

No. Poles	Mo. Poles	Switch Function		Connected Terminals		Schematic
		POS. 1	POS. 2	POS. 1	POS. 2	
		C&K marking this side				
DP	8261	ON	ON	2-3, 5-6	2-1, 5-4	

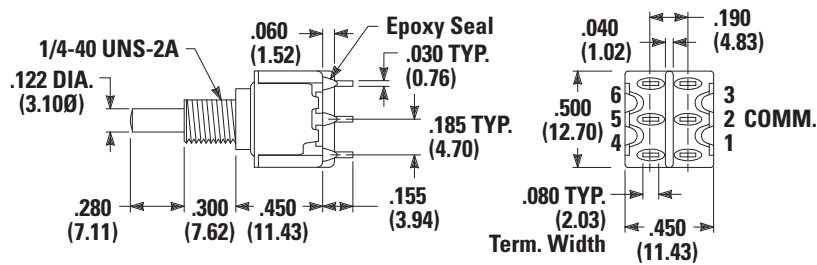

Part Number Shown: 8221SHZGE

Terminal Nos. For Reference Only

Actuator - Snap-in Front Mount

J80 Snap-in

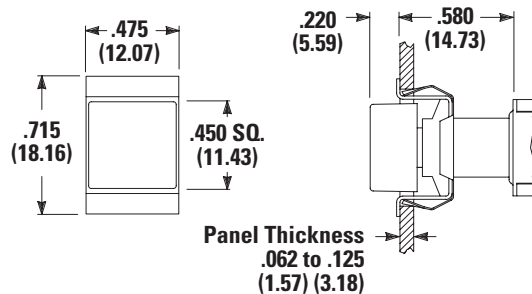

PC Mounting

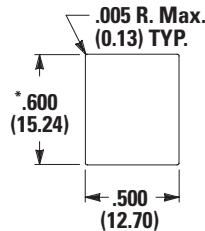

Notes: Increase this dimension to 0.620/0.625 (15.75/15.88) for 0.091/0.125 (2.41/2.18) thick panels.

Option Code	Cap Color
2	Black
1	White
3	Red
4	Orange
5	Yellow
9	Gray

J81 Snap-in with Black Frame

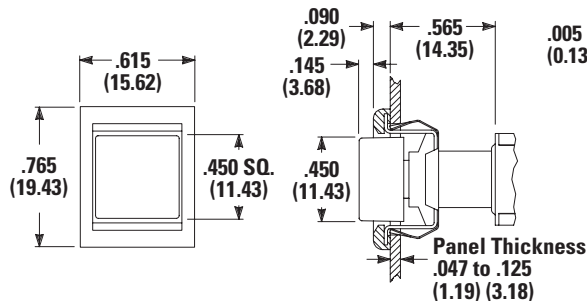

PC Mounting

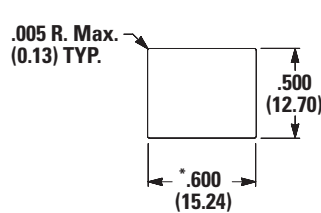

Notes: Increase this dimension to 0.620/0.625 (15.75/15.88) for 0.091/0.125 (2.41/2.18) thick panels.

Notes: Cap Finish: matte. Other colors available, consult Customer Service Center. Available with C, W, Z or Z3 terminations. Caps & frames available separately, see pages 11-13.

8060 Series

Alternate Action and Momentary Pushbutton Switches



J82 Snap-in with Black Frame for LED

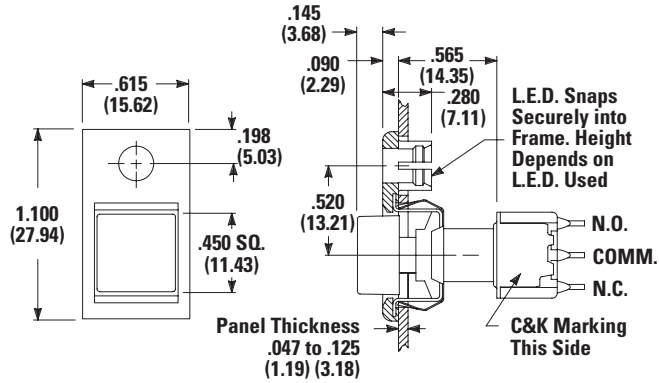

Notes:
Available with C, W, Z or Z3 terminations.

PC Mounting

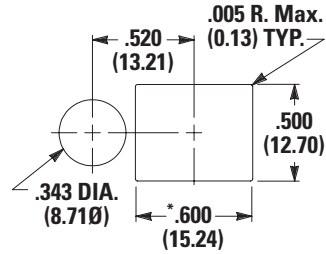

Notes:
*Increase this dimension to 0.620/0.625 (15.75/15.88) for 0.091/0.125 (2.41/2.18) thick panels.

Option Code	Cap Color
2	Black
1	White
3	Red
4	Orange
5	Yellow
9	Gray

Notes:
LED not included. For LED information, see page 13. Caps & frames available separately, see pages 11-13. Other colors available, consult Customer Service Center.

J86 Snap-in with Black Frame and LED 8161J86ZQE223 SPDT

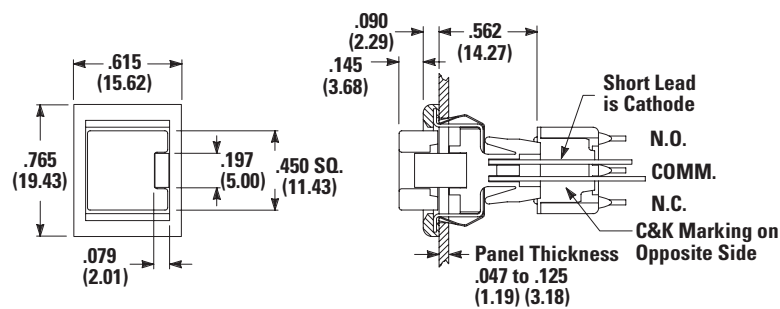

Notes:
Available with C, W, Z or Z3 terminations and SPDT models only.

PC Mounting

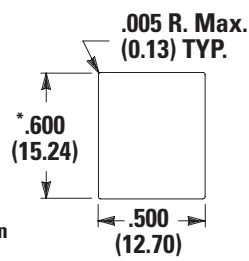

Notes:
*Increase this dimension to 0.620/0.625 (15.75/15.88) for 0.091/0.125 (2.41/2.18) thick panels.

Option Code	Cap Color
2	Black
1	White
3	Red
4	Orange
5	Yellow
9	Gray

Notes:
Caps & frames available separately, see pages 11-13. Other colors available, consult Customer Service Center.

Option Code	LED Color
3	Red

Notes:
For LED information, see page 13.

8060 Series

Alternate Action and Momentary Pushbutton Switches



Plunger

S Plunger with Cap P/N 7527

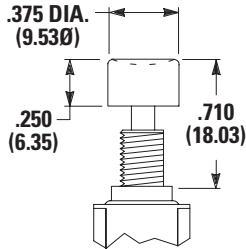

S1 Plunger with Cap P/N 7089

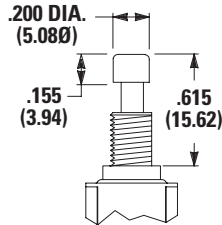

S2 Plunger with Cap P/N 8018

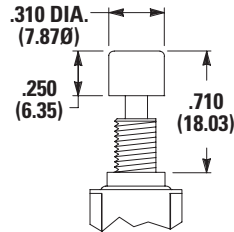

S, S1, S2, Plunger Dimensions

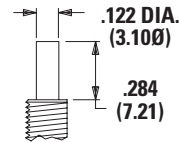

Plunger material: Glass filled nylon or glass filled polyester (UL 94 V-0)

L Plunger with Cap P/N 8941

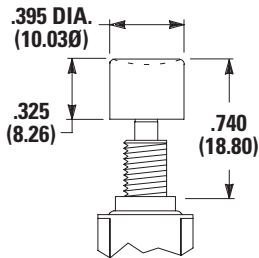

L1 Plunger with Cap P/N 8940

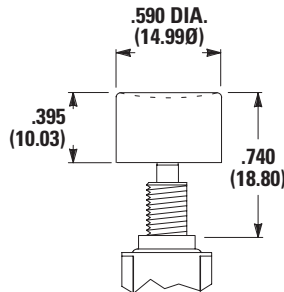

L, L1 Plunger Dimensions

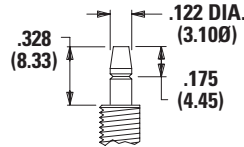

Plunger material: Brass, chrome plated.

Option Code	Cap Color
2	Black
1	White
3	Red
4	Orange
5	Yellow
9	Gray

Notes:
Cap Finish: gloss. Cap supplied not installed.
Other colors available, consult Customer Service Center.

Notes: When selecting plunger and cap option, bushing selection must also be made, see below.

Bushing

H 0.300" High Threaded, Flat H9 0.300" High Unthreaded, Flat

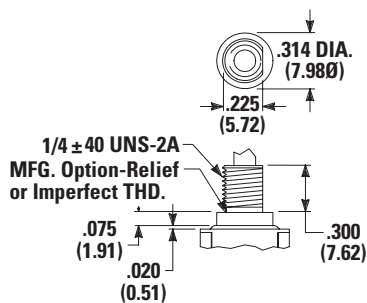

None No Bushing Choice Required (JXX Actuators)

Y3 7.6mm Threaded, Keyway

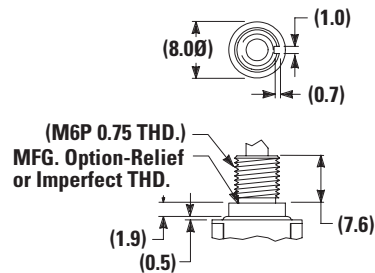

Notes:
Withstands 12 in./lbs. of torque with no distortion.

Notes:
H bushing standard with C, W, Z or Z3 terminations. H9 bushing standard with A, A3, AV2, AV3, or V3-V31 terminations. Withstands 12 in./lbs. of torque with no distortion.

When selecting bushing option, plunger selection must also be made, see above. No bushing option choice required when any JXX actuator option is selected.

8060 Series

Alternate Action and Momentary Pushbutton Switches



Panel Mounting

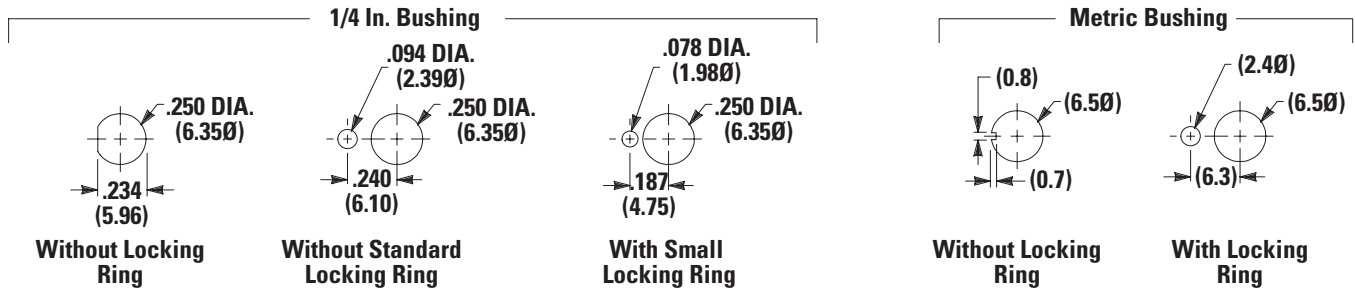

Notes: Two mounting nuts, locking ring and lockwasher supplied standard with threaded bushings. Optional mounting nut and locking ring styles and finishes available, see section "Technical Data and Additional Hardware".

Terminations

C PCThru-hole SPDT and DPDT

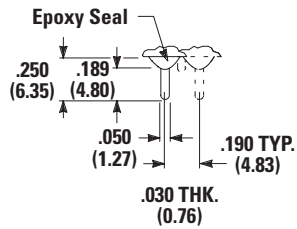

PC Mounting

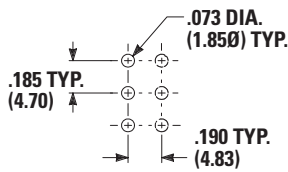

Z Solder Lug SPDT and DPDT

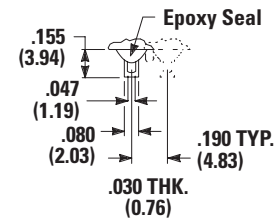

Notes: Not available with P, S or R contact material.

Z3 Quick Connect SPDT and DPDT

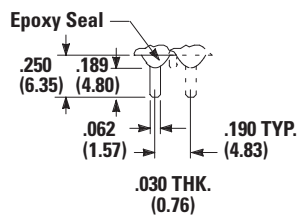

W Wire Wrap SPDT and DPDT

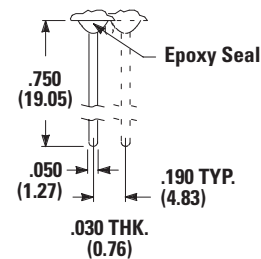

Notes: Not available with P, S or R contact material. Mating quick connector available; order part number 530100000, page 12.

8060 Series

Alternate Action and Momentary Pushbutton Switches



A Right Angle, PC Thru-hole

8161SH9ABE2 SPDT

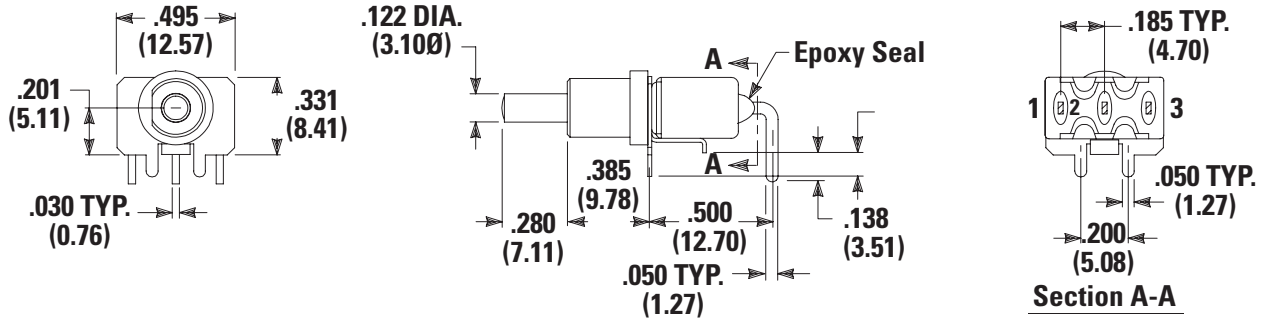

A3 Right Angle, Snap-in, PC Thru-hole

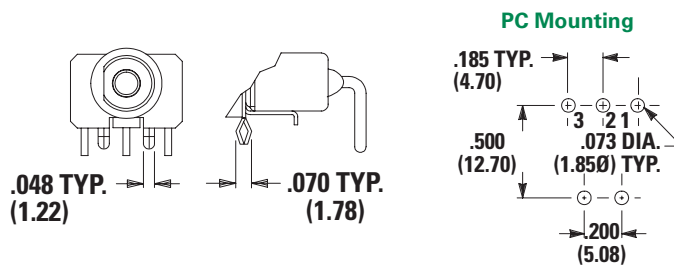

Notes:
Not available with I seal. Terminal bend radii and lead-in manufacturing option. PC pattern must clear switch support leg.

A Right Angle, PC Thru-hole

8261SH9ABE2 DPDT

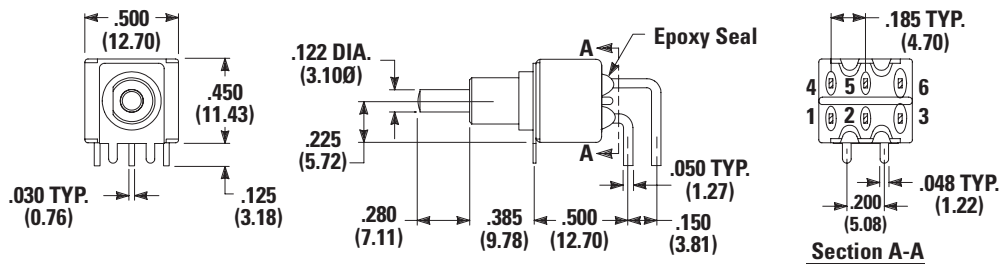

8060 Series

Alternate Action and Momentary Pushbutton Switches



A3 Right Angle, Snap-in, PC Thru-hole

PC Mounting

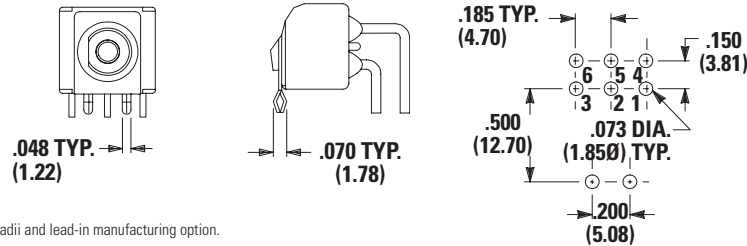

Notes:
Not available with I seal. Terminal bend radii and lead-in manufacturing option.

AV2 Vertical Right Angle, PC Thru-hole, 0.150" Pitch

8161SH9AV2BE2 SPDT

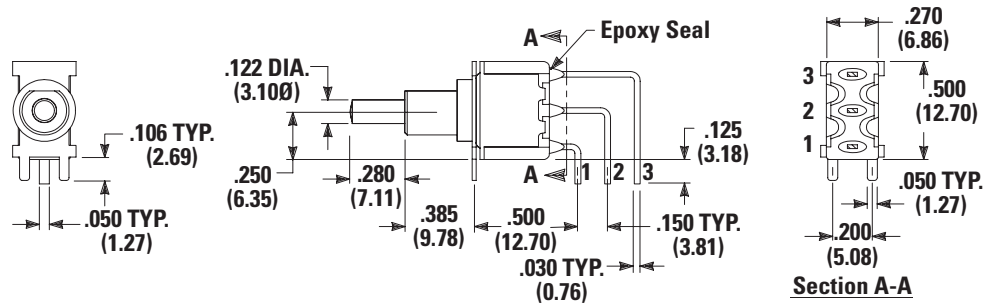

AV3 Vertical Right Angle, Snap-in, PC Thru-hole, 0.150" Pitch

PC Mounting

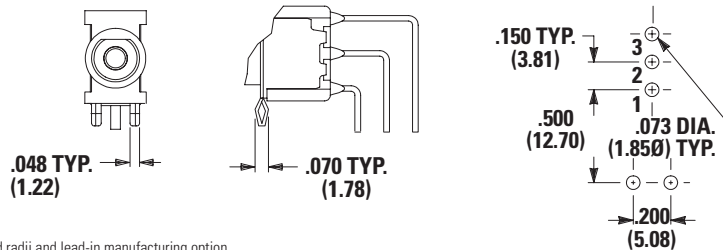

Notes:
Not available with I seal. Terminal bend radii and lead-in manufacturing option.

AV2 Vertical Right Angle, PC Thru-hole, 0.150" Pitch

8261SH9AV2BE2 DPDT

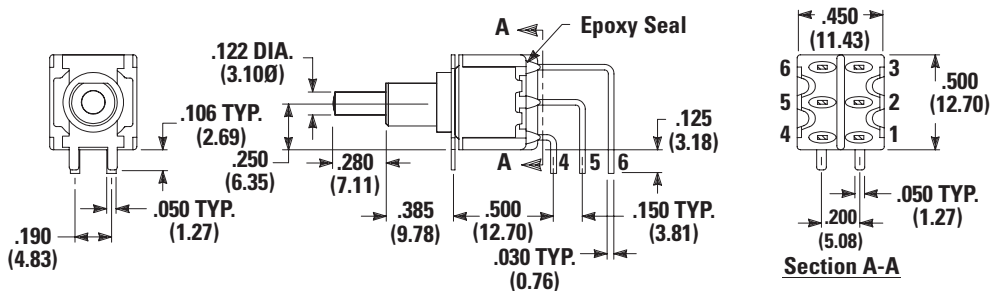

8060 Series

Alternate Action and Momentary Pushbutton Switches



AV3 Vertical Right Angle, Snap-in, PC Thru-hole, 0.150" Pitch

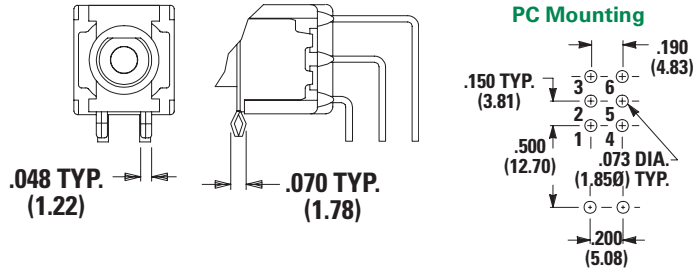

Notes:
Not available with I seal. Terminal bend radii and lead-in manufacturing option.

V6 Vertical Mount, V-Bracket V21 Vertical Mount, V-Bracket, Snap-in 8161SH9_BE2 SPDT

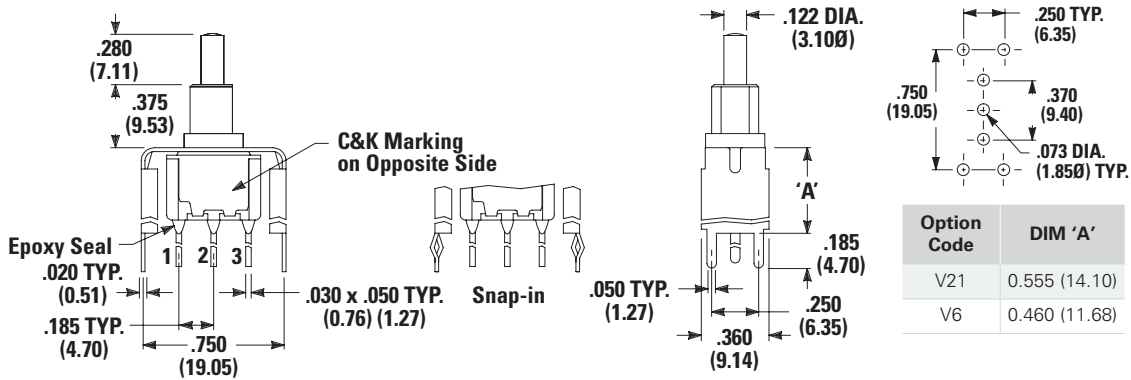

Notes:
Not available with I seal.

V6 Vertical Mount, V-Bracket V21 Vertical Mount, V-Bracket, Snap-in 8261SH9_BE2 DPDT

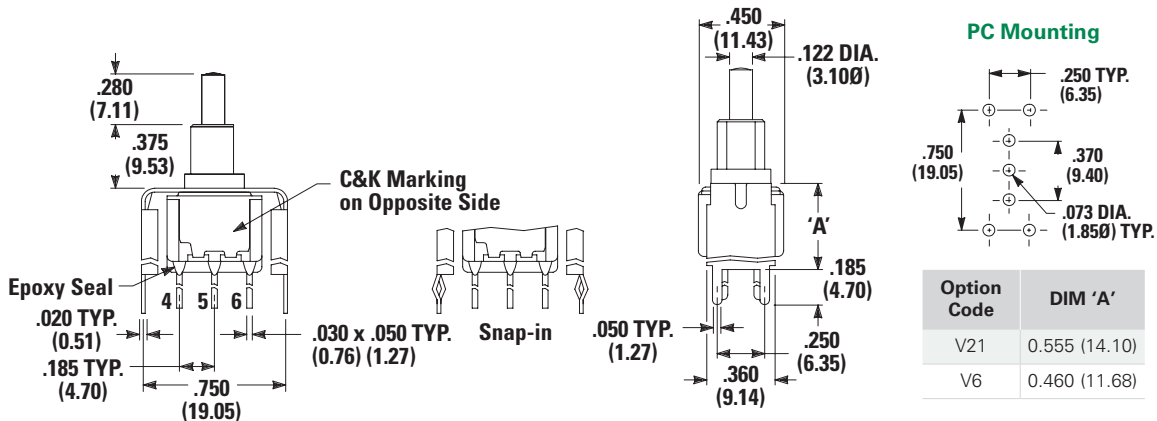

Notes:
Not available with I seal.

8060 Series

Alternate Action and Momentary Pushbutton Switches



V3, V4 Vertical Mount, V-Bracket V31 Vertical Mount, V-Bracket, Snap-in

8161SH9_BE2 SPDT

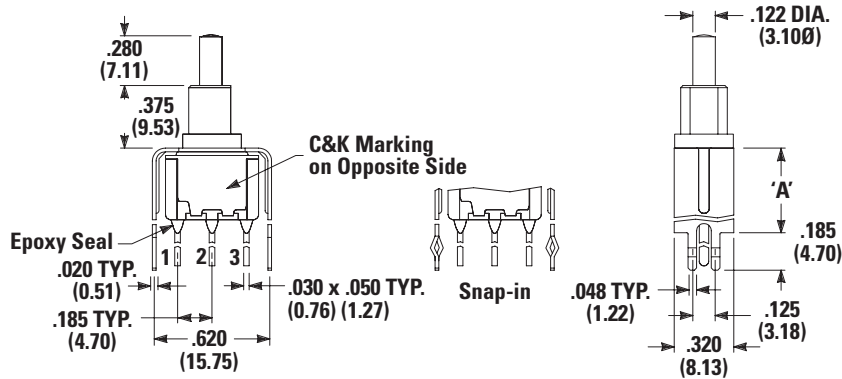

PC Mounting

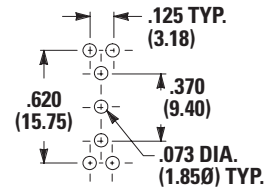

Option Code	DIM 'A'
V3, V31	0.460 (11.68)
V4	0.630 (16.00)

Notes:
Not available with I seal.

V3, V4 Vertical Mount, V-Bracket V31 Vertical Mount, V-Bracket, Snap-in

8261SH9_BE2 DPDT

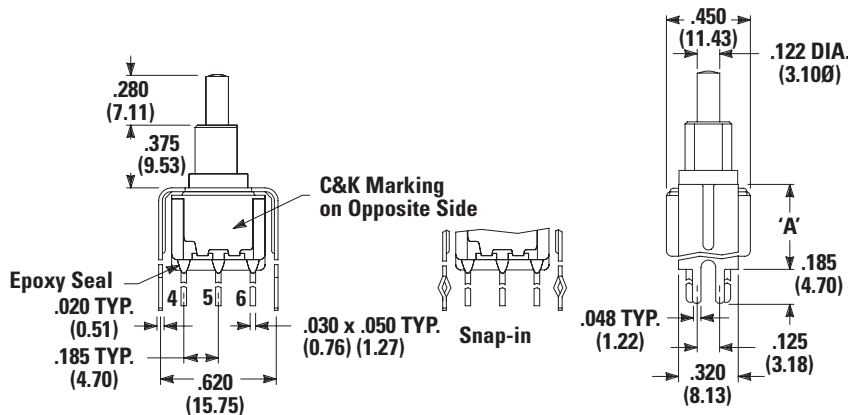

PC Mounting

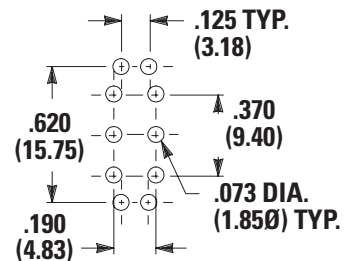

Option Code	DIM 'A'
V3, V31	0.460 (11.68)
V4	0.630 (16.00)

Contact Material

Option Code	Contact Material	Terminal Plating	Ratings
B	Gold ¹	Gold ¹	Low Level/Dry Circuit
P		Matte-Tin ⁶	
Q	Silver ^{4,5}	Silver ⁵	Power
S		Matte-Tin ⁶	
G	Gold over Silver ^{2,3}	Gold ³	Low Level/Dry Circuit or Power
R		Matte-Tin ⁶	

0.4 VA Max. @ 20 V AC or DC Max.
6 amps @ 120 V AC or 28 V DC; 3 AMPS @ 250 V AC
0.4 VA Max @ 20 V AC OR DC Max. or 1 amp @ 120 V AC or 28 V DC; 3 amps @ 250 V AC

Notes:
See Technical Data section of this catalog for RoHS compliant and compatible definitions and specifications.

- Contacts & Terminals:** Copper alloy, with gold plate over nickel plate.
- End Contacts:** Coin silver, with gold plate over nickel plate.
- Center Contacts & All Terminals:** Copper alloy, with gold plate over nickel plate.
- End Contacts:** Coin silver, silver plated.
- Center Contact & All Terminals:** Copper alloy, silver plated.
- Terminals:** Copper alloy, with matte-tin over nickel plate.

Any models supplied with P, S, R, Q, B or G contact material are RoHS compliant. All models with all options when ordered with S, R, G, or Q contact material. B contact material standard with all terminations except C, Z & Z3. Q contact material standard with C, Z & Z3 terminations. P, S & R contact materials not available with Z & Z3 terminations.

8060 Series

Alternate Action and Momentary Pushbutton Switches



Seal

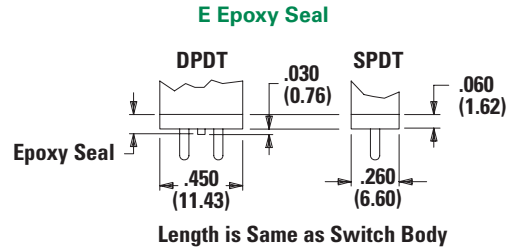
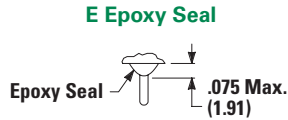

Notes:
Available with C, W, Z, Z3 terminations only.

Available Hardware

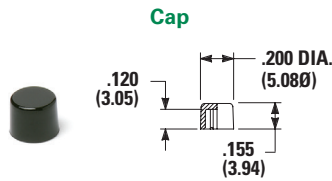

PART NO.
708901000 WHITE
708902000 BLACK
708903000 RED
708904000 ORANGE
708905000 YELLOW
708909000 GRAY
Material: Nylon
Finish: Gloss

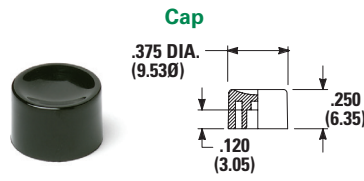

PART NO.
752701000 WHITE
752702000 BLACK
752703000 RED
752704000 ORANGE
752705000 YELLOW
752709000 GRAY
Material: Nylon
Finish: Gloss

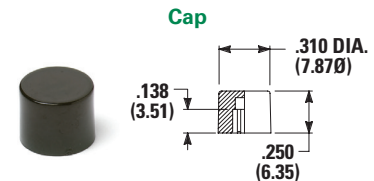

PART NO.
801801000 WHITE
801802000 BLACK
801803000 RED
801804000 ORANGE
801805000 YELLOW
801809000 GRAY
Material: Nylon
Finish: Gloss

Cap, Snap Fitting Plunger

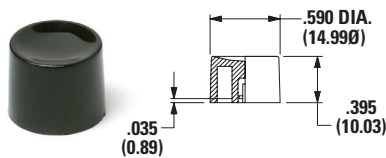

PART NO.
452D01000 WHITE
452D02000 BLACK
452D03000 RED
452D04000 ORANGE
452D05000 YELLOW
452D09000 GRAY
Material: Nylon
Finish: Gloss

Cap, Snap Fitting Plunger

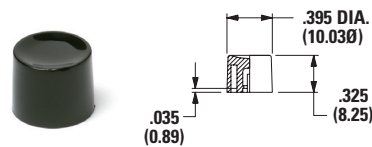

PART NO.
894101000 WHITE
894102000 BLACK
894103000 RED
894104000 ORANGE
894105000 YELLOW
894109000 GRAY
Material: Nylon
Finish: Gloss

Cap, J80, J81 & J82 options only

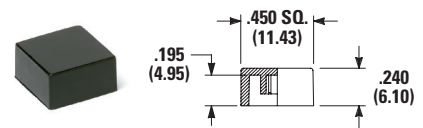

PART NO.
484601000 WHITE
484602000 BLACK
484603000 RED
484604000 ORANGE
484605000 YELLOW
484609000 GRAY
Material: Nylon
Finish: Gloss

PART NO.
798201000 WHITE
798202263 BLACK
798203000 RED
798204000 ORANGE
798205000 YELLOW
798209000 GRAY
Material: Nylon
Finish: Matte

8060 Series

Alternate Action and Momentary Pushbutton Switches



Frame



PART NO.
6156022263 BLACK
Material: Nylon
Finish: Matte

Frame

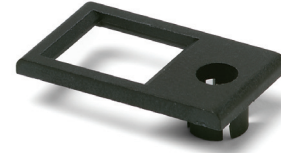

PART NO.
613302263 BLACK
Material: Nylon
Finish: Matte

Cap, J86, J96 Options Only

PART NO.
459701000
459702000
459703000
459704000
459705000
459709000
Material: Nylon
Finish: Matte

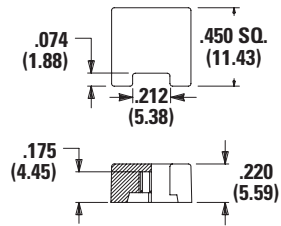

Fits Z3 Termination Female Connector

PART NO.
530100000
Available in loose pieces.



Notes: Additional nuts, locking rings and lockwashers available separately, see section "Technical Data and Additional Hardware". Other cap & frame colors available, consult Customer Service Center.

8060 Series

Alternate Action and Momentary Pushbutton Switches



Frames snap into panel opening and are independent from switch mounting. Accurate positioning of the PC mounted switch relative to the panel opening is necessary to provide proper clearance between actuator and frame. Available in two basic styles and four panel thicknesses 0.047-0.125 in. Material: Nylon. Finish: Matte.

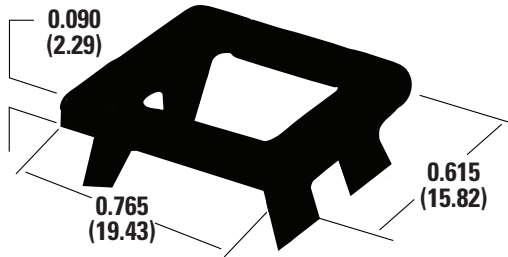

0.090" (2.29) PANEL THK.
PART NO. 432702263

0.125" (3.18) PANEL THK.
PART NO. 432802263
BLACK

Typical Application

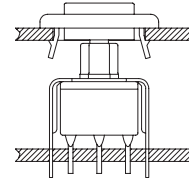

Panel Inserts

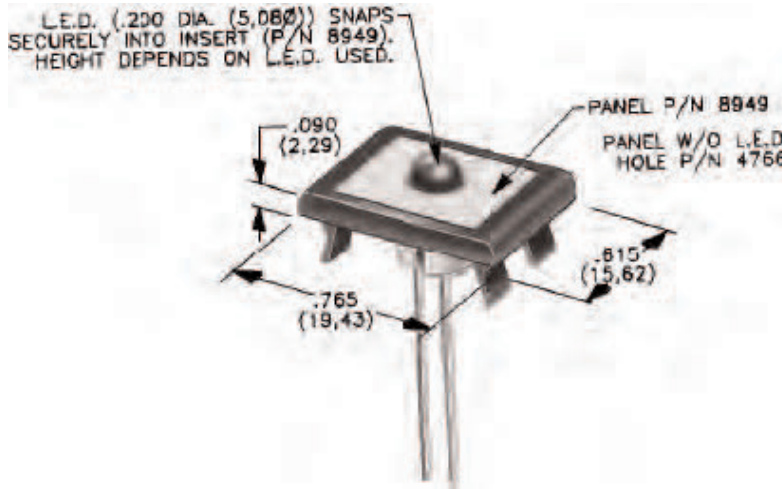

Panel Inserts

For Part Numbers
4325xxxxxx, 4326xxxxxx

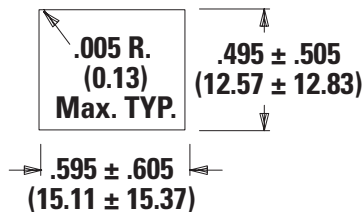

For Part Numbers
4326xxxxxx, 4328xxxxxx

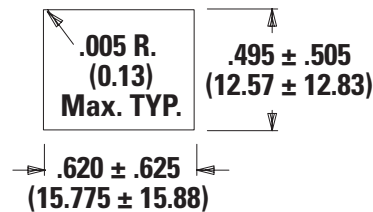

Above frames (part nos. 432XXXXXX) are also available with insert which accepts LED for indicator light assembly. Order insert separately from frame. Blank insert panel (without hole for LED) also available. LED not included.

PANEL INSERT WITH HOLE FOR LED
PART NO. 894902000

BLANK PANEL INSERT WITHOUT HOLE FOR LED
PART NO. 476602000 BLACK

Special colors, custom markings available, consult Customer Service Center.

8060 Series

Alternate Action and Momentary Pushbutton Switches



LED Information

Switches with LED supplied: J86 OPTIONS: Rectangular LEDs are supplied on 8060 Series pushbutton switches with J86 options. These LEDs are factory installed and are not replaceable. The following specifications apply:

Option Code	Color	Typ. Intensity	Typ. Forward Voltage	Typ. Forward Current	Max Rating at 25°C Ambient Temperature		
					Forward Voltage	Continuous Forward Current	Power Dissipation
6	Green	1.0 mcd		20 mA		50 mA	125 mW
3	Red ¹	0.5 mcd	2.1 V	10 mA	2.5 V	30 mA	75 mW
5	Yellow	4.0 mcd		20 mA		50 mA	125 mW

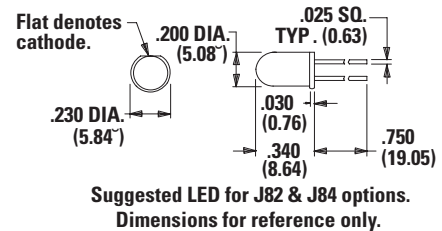

Process Information: Soldering to LED leads must be completed within 5 seconds at 500°F (260°C) maximum.

Caution: Circuit elements must limit forward current of LED to 50mA max. continuous.

1. Extra-bright red LED available (typ. intensity 4.5 mcd), consult Customer Service Center.

LEDs are not supplied with J82, J84 options. LED snaps into switch frame surrounding actuator and is wired externally.