

V-Series

Sealed Rocker Switches

PRODUCT WEBPAGE

request sample, configure part, watch video



Contura® IP66/68 Snap-In Mounted Switches

These switches are a staple in the marine and transportation industries and have passed a range of environmental, corrosion, temperature, vibration, shock and sealing tests including MIL Std 202F, MIL Std 510.1, UL 1500, ISO 8846, IEC 60529 and BS 5490 among others, making them one of the most rugged and reliable switches ever manufactured.

1-2
Poles

.4-20
Amps

125-250
VAC

12-24
VDC

Typical Applications

- On/Off-Highway
- Marine
- Armoured Vehicles
- Mining Machinery
- Any Application Requiring Sealing Protection

Design Features

INTERCHANGEABLE ACTUATORS

Panel redesign is a snap with our wide range of rocker styles. Achieve maximum design variety with minimum inventory. Simply swap rockers to create an entirely new look for your panel.

DUAL SEAL PROTECTION

Seals out water, dust, debris, and sealed to IP66/68 for above-panel components

CLEAN CONNECTIONS

Options for both eight and ten terminal base styles with AMP & Packard compatible connectors affords myriad circuit options while providing ease of assembly.

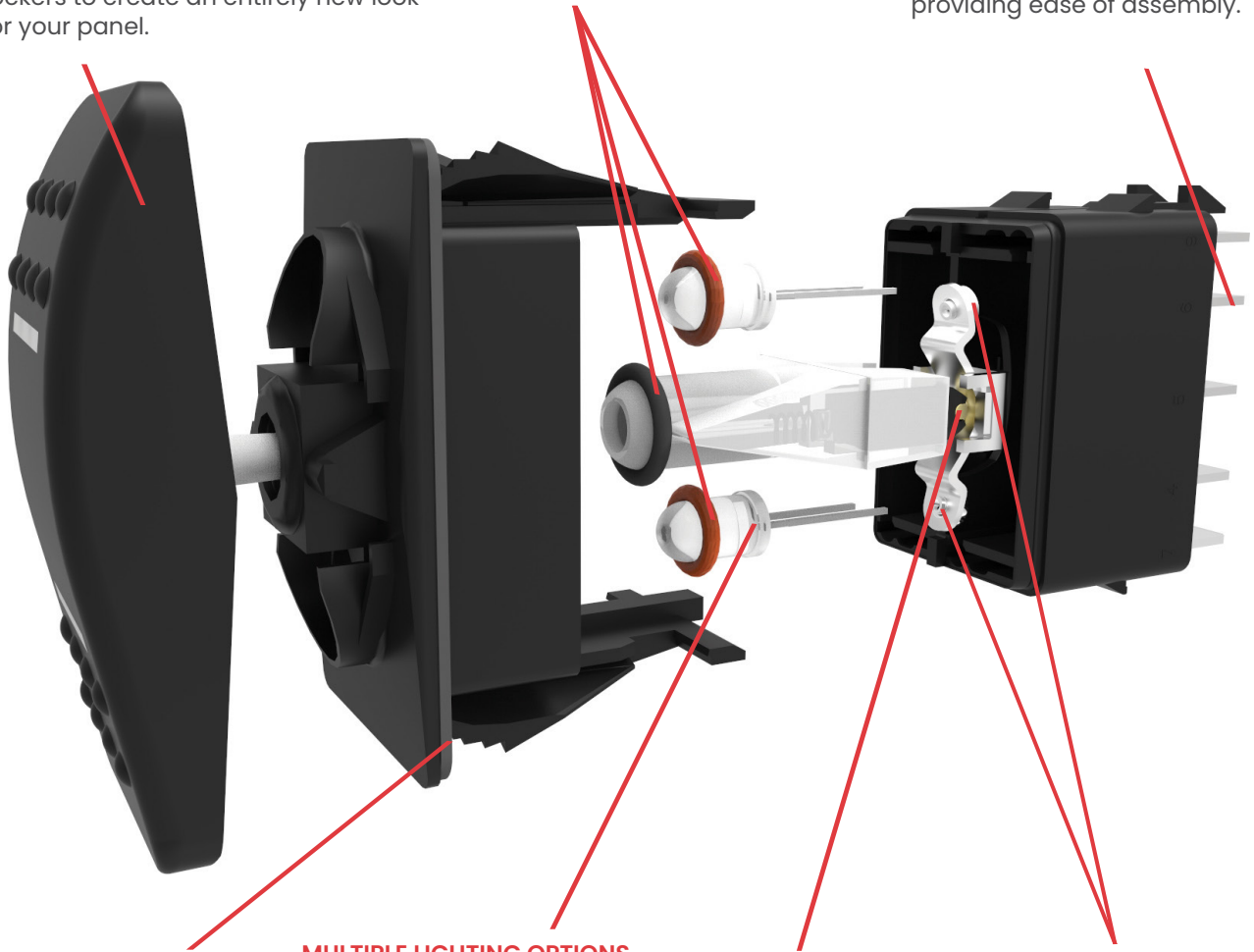

OPTIONAL PANEL SEAL

Helps prevent water/dust ingress behind panel.

MULTIPLE LIGHTING OPTIONS

In addition to Incandescent lamps, our LED illumination is offered in a wide array of light intensities, colors, as well as dual level, tri-color, and flashing options.

BRASS ROLLER PIN

Robust mechanism eliminates the need for lubricants. Enables switch to withstand -40°C to +85°C temperatures.

SILVER PLATED BUTT CONTACT MECHANISM

Providing 50k to 100k electrical cycles, circuit and load dependent

Actuator Options & Accessories



Contura II & III

The Contura II & III actuators are constructed of thermoplastic polycarbonate and are offered with a hard nylon overlay or a “soft-touch” elastomer overlay. These models incorporate aesthetic designs on the top and bottom of the rocker featuring two rows of raised “bumps” on the Contura II and three “indented” lines on the Contura III.



Contura IV

The Contura IV’s “Shape to create a Shape” actuator works with the curves, contours & advanced styling of the latest panel designs, flowing with these advanced curves & radii. This actuator style fits on the Contura flush bracket/bezel.



Contura V

The symmetrically curved Contura V actuator provides the perfect complement to the Contura IV’s “Shape to create a Shape” design concept. With its flush style mounting bracket, Contura V can be mounted in between two Contura IV’s, by itself, or in groups.



Contura X

The raised bracket/bezel on the Contura X helps prevent debris from being trapped under the actuator. This curved rocker style is available with a variety of lenses and legends.



Contura XI

The raised bracket/bezel on the Contura XI helps prevent debris from being trapped under the actuator. This convex style rocker is available with a wide variety of lenses and legends.



Contura XII

The Contura XII version features a paddle style actuator with the raised bracket/bezel of Contura X and XI. The contoured handle design provides intuitive recognition and ease of operation and is available with all Contura X and XI lens and legend offerings.



Contura XIV

The Contura XIV represents a sleek new crossover rocker design which should appeal to Trucks, Buses and Heavy Vehicles as well as the Marine Industry. Intuitive feel is provided by recessed ridges along with a Center Groove which effectively defines the boundary between top and bottom switch functions.



Illuminated Indicators & Accessories

Alert operator of systems functions or malfunctions, are offered with removable/replaceable lamps in Contura II, IV, V or X styles. Accessories include connectors, mounting panels, hole plugs, panel seals, and actuator removal tools. Refer to accessories page for full details.

Tech Specs

Electrical

| | |
|----------------------------|--|
| Contact Rating | 4VA @ 24VDC (MAX) resistive 15 amps, 125VAC 10 amps, 250VAC 1/2 HP 125-250VAC 20 amps, 4-14VDC 15 amps, 15-28VDC 10A, 14VT 6A, 125VAC L |
| Dielectric Strength | 1500 Volts RMS |
| Insulation Resistance | 50 Megohms |
| Initial Contact Resistance | 10 milliohms max. @ 4VDC |
| Life | Up to 100,000 cycles, circuit and load dependent |
| Contacts | Silver alloy, silver tin-oxide, fine silver |
| Terminals | Brass or copper/silver plate 1/4" (6.3mm) Quick Connect terminations standard. Solder lug, Wire Lead |

Physical

| | |
|----------------------------------|---|
| Lighted | Incandescent - rated 10,000 hours Neon - rated 25,000 hours LED - rated 100,000 hours 1/2 life (LED is internally ballasted for voltages to 24VDC) |
| Seals | Internal optional external gasket panel seal |
| Base | Polyester blend rated to 125°C with a UL flammability rating of 94V0. |
| Contura II, III, IV, V Actuators | Hard Surface: Basic actuator structure molded of thermoplastic polycarbonate with a hard Nylon 66 thermoplastic surface overlay. Soft Surface: Basic actuator structure molded of thermoplastic polycarbonate with an elastomer overlay. |
| Contura X, XI, XII Actuators | Nylon 66 Reinforced rated to 105°C |
| Lens | Polycarbonate rated at 100°C |
| Contura XIV Actuator | Polycarbonate lens/sub-rocker with ABS shell |

Actuator Travel (Angular Displacement)

| | |
|-------------|----------------|
| 2 position | 18° |
| 3 positions | 9° from center |

Environmental

| | |
|---------------------|---|
| Sealing | IP66/68, for above-panel components of actual switch only. |
| Corrosion | Mixed Flowing Gas (MFG) Class III 3 year accelerated exposure per ASTM B-827, B-845 Silver and gold contacts |
| Operating Temp | -40°C to +85°C |
| Vibration 1 | Per Mil-Std 202F, Method 204D Test Condition A 0.06 DA or 10G's 10-500 Hz. Tested with VCH connector. Test criteria - No loss of circuit during test, pre and post test contact resistance. |
| Vibration 2 | Resonance search 24-50 Hz 0.40 DA 50-2000 Hz ±10 G's peak Horizontal Axis 3-5 G's max. Random 24 Hz 0.06 PSD-Gsq/Hz 60 Hz 0.50 100 Hz 0.50 200 Hz 0.025 2000 Hz 0.025 No loss of circuit during test; <10µ seconds chatter. |
| Shock | Per Mil-Std 202F, Method 213B, Test Condition K @ 30G's. Tested with VCH connector. Test criteria - No loss of circuit during test, pre and post test contact resistance. |
| Salt Spray | Per Mil-Std 202F, Method 101D, Test Condition A, 96 Hrs. Sealed version only. |
| Dust | Mil STD 810, Method 510.2 Air Velocity 300 Ft/Min Duration 16Hr |
| Thermal Shock | Per Mil-Std 202F, Method 107F, Test Cond. A, -55°C to +85°C. Test criteria -pre and post test contact resistance |
| Moisture Resistance | Per Mil-Std 202F, Method 106F, Test Criteria - pre and post test contact resistance |
| Ignition Protection | All Contura switches with sealed construction meet the requirements of UL1500/ISO8846 for ignition protection, in addition to conformance with EC directive 94/25/EC for marine products. |

Mounting Specifications

Panel Thickness Range
Gaskets Acceptable Panel Thickness

| | |
|---|--|
| 0 | .030 to .250 (.76 to 6.35mm) |
| 1 | .030 to .109 & .147 to .157 (.76 to 2.77mm & 3.73 to 3.98mm) |

Recommended: No gasket with panel thickness of .032, .062, .093, .125, .187 or .250

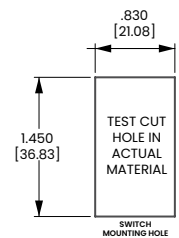

Ordering Scheme

Contura II & III

Sample Part Number

V 1 D A B T 0 B - A R B 00 - 0 00

Selection

1 2 3 4 5 6 7 8 9 10 11 12 13 14

1. SERIES

V V-Series

2. CIRCUIT

Terminal Connections as viewed () - momentary from bottom of switch: SP - single pole: terminals 1, 2 & 3.
8 terminal **10 terminal** DP - double pole: terminals 1, 2, 3, 4, 5 & 6.
 8 - - 7 8 - - 7 Terminals 7, 8, 9 & 10 for lamp circuit only.
 1 - - 4 1 - - 4
 2 - - 5 2 - - 5
 3 - - 6 3 - - 6
 10 - - 9

| Position: | 1 | 2 | 3 |
|-----------|--------------|---------------------|--------------|
| SP DP | 2 & 3, 5 & 6 | Connected Terminals | 1 & 2, 4 & 5 |
| 1 A | ON | NONE | OFF |
| 2 B | (ON) | NONE | OFF |
| 3 C | ON | NONE | (OFF) |
| 4 D | ON | NONE | ON |
| 5 F | ON | NONE | (ON) |
| 6 J | ON | OFF | ON |
| 7 K | ON | OFF | (ON) |
| 8 L | (ON) | OFF | (ON) |

| SPECIAL CIRCUITS | 2 & 3 | 2 & 3, 5 & 4 | 5 & 4 |
|------------------|----------------|--------------|-------|
| H* | 2 & 3 | 2 & 3, 5 & 4 | 5 & 4 |
| G* | 2 & 3, 5 & 6 | 2 & 3 | OFF |
| S* | 2 & 3, 5 & 6 | 2 & 3 | 1 & 2 |
| M* | (2 & 3, 5 & 6) | 2 & 3 | OFF |
| R* | (2 & 3, 5 & 6) | 2 & 3 | 2 & 1 |
| E* | 5 & 6 | 5 & 3 | 5 & 1 |

Jumper between terminals 2 & 5 for circuits H,G,M,R & S are specified in selection 4. External jumper between terminals 2 & 4 for circuit E are provided by customer. Circuit E may be used for SP OFF-ON-ON circuit.

3. RATING 3

| | |
|---|---|
| 1 | .4VA @ 28VDC Resistive |
| 5 | 10A 250VAC 1/2 HP, 15A 125 VAC 1/2 HP, UL Recog., CSA Certified |
| B | 15A 24V |
| C | 20A 18V |
| D | 20A 12V |
| E | 20A 14V, 10A 14VT (circuit 1, 4, A & D only) |
| F | 10A 14V, 6A 14VT (circuit G only) |

4. TERMINATION / BASE STYLE

| 8 term | 10 Term | Termination | Jumper |
|--------|---------|-----------------------------|-------------|
| 1 | 2 | .250 TAB (QC) no barriers | No |
| A | B | .250 TAB (QC) with barriers | No |
| J | K | .250 TAB (QC) no barriers | Yes T2 to 5 |
| 3 | 4 | Solder Lug no barriers | No |
| C | D | Solder Lug | No |
| 5 | 6 | Wire Leads no barriers | No |
| E | F | Wire Leads | No |

Note: Codes J & K for circuits H, G & M. Do not use silicone based lubricants to reduce terminal insertion forces during connector assembly, as it is detrimental to function and performance.

5. ILLUMINATION

Lamp #1: above terminals 1 & 4 end of switch.; Lamp #2 above terminals 3 & 6 end of switch. Positive (+) and negative (-) symbols apply to LED lamps only

| Sealed | Lamps | illumination Type | Lamp wired to Terminals |
|--------|-------|-------------------|-------------------------|
| S | NONE | | |
| A | 1 | INDEPENDENT | 8 (+) 7 (-) |
| B | 1 | DOWN | 3 (+) 7 (-) |
| C | 2 | UP | 3 (+) 7 (-) |
| D | 1 | DOWN | 3 (+) 7 (-) |
| E | 2 | DOWN | 1 (+) 7 (-) |
| F | 1 | UP | 1 (+) 7 (-) |
| G | 2 | UP | 3 (+) 7 (-) |
| H | 1 | INDEPENDENT | 8 (+) 7 (-) |
| U | 2 | UP | 3 (+) 7 (-) |
| J | 1 | DOWN | 3 (+) 8 (-) |
| K | 2 | INDEPENDENT | 6 (+) 7 (-) |
| L | 1 | INDEPENDENT | 8 (+) 7 (-) |
| M | 2 | INDEPENDENT | 6 (+) 7 (-) |
| N | 1 | DOWN | 3 (+) 6 (-) |
| P | 2 | DOWN | 1 (+) 4 (-) |
| | 1 | UP | 1 (+) 4 (-) |
| | 2 | UP | 3 (+) 6 (-) |

6,7. LAMP (SAME CODING FOR BOTH SELECTIONS)

Selection 6: above terminals 1 & 4; Selection 7: above terminals 3 & 6
 No lamp 0
 Neon 1 125VAC 2 250VAC

| LED* | Red | Amber | superbright Green | superbright Red |
|-------|-----|-------|-------------------|-----------------|
| 2VDC | A | L | F | R |
| 12VDC | C | N | H | T |
| 24VDC | D | P | J | V |

* Consult factory for "daylight bright" LED options. Typical current draw for LED is 20ma.

8. FLUSH BRACKET COLOR, PANEL SEAL 1

| | |
|----------|-------|
| No Seal | Black |
| One Seal | B |
| | C |

9. ACTUATOR

| | | | |
|------|-------------|--|--|
| 0 | No Actuator | | |
| A, B | Contura II | | |
| C, D | Contura III | | |

Actuator thick end over terminals: 1,4 3,6

10. LENS 1

| 0 - No Actuator | White | Z - No Lens | Amber | Green | Red | Blue |
|-----------------|-------|-------------|-------|-------|-----|------|
| 1 | 6 | B | G | M | T | |
| 2 | 7 | C | H | N | U | |
| 3 | 8 | D | J | P | V | |
| 4 | 9 | E | K | R | W | |
| 5 | A | F | L | S | Y | |

Square lens options only available for Contura II.
 Lens color for LEDs must be clear, white, or match color of LED. Green or blue lenses are not recommended with Neon lamps.

11. ACTUATOR COLOR AND TEXTURE 1

| | | |
|-----------------|-------|-----|
| 0 - No Actuator | Black | Red |
| Soft Surface | B | R |
| Hard Surface | C | S |

12. ACTUATOR LENS OR BODY LEGENDS 2

| | | | | | | | | |
|----|-----|----|-----|----|-----|----|-----|--|
| 11 | ON | 12 | OFF | 13 | I | 14 | O | |
| | OFF | | ON | | O | | I | |
| 15 | O O | 16 | O O | 17 | O I | 18 | I O | |
| | F N | | N F | | F | | F | |

For additional legend options & codes, visit us at www.carlingtech.com

13. LEGENDS ORIENTATION

| | | |
|---|---|--|
| 0 | No legend (used with codes 11-18 in selection 12) | |
| 1 | Orientation 1 | |
| 2 | Orientation 2 | |
| 3 | Orientation 3 | |
| 4 | Orientation 4 | |

14. ACTUATOR LENS LEGENDS

00 No legend this location / no actuator (used with codes 11-18 in selection 12) Selection 14 required when switch requires two legends. If the two legends consist of one lens and one body legend, lens legend must be specified in selection 12; body legend specified in selection 14. For legend options & codes, visit us at www.carlingtech.com.

Notes:

- Consult factory to verify horsepower rating for your particular circuit choice.
- Custom colors are available. Consult factory.
- Body legends not available on Soft surface actuators; White imprinting is standard on black actuators; Black imprinting is standard on white, red and gray actuators. Custom colors are available, consult factory.
- Additional ratings available. See V-Series Switch Accessories page.
- Contura II available with two square lenses. Consult factory for details.

[Configure Complete Part Number >](#)

[Browse Standard Parts >](#)

Ordering Scheme

Contura II & III locking

Sample Part Number

V 1 D A S W 0 B - A Z E 00 - 0

Selection 1 2 3 4 5 6 7 8 9 10 11 12 13

1. SERIES

V V-Series

2. CIRCUIT

Terminal Connections as viewed () - momentary from bottom of switch: SP - single pole: terminals 1, 2 & 3. DP - double pole: terminals 1, 2, 3, 4, 5 & 6. Terminals 7, 8, 9 & 10 for lamp circuit only.

| | | |
|------------|-------------|--|
| 8 terminal | 10 terminal | DP - double pole: terminals 1, 2, 3, 4, 5 & 6. |
| 8 -- 7 | 8 -- 7 | Terminals 7, 8, 9 & 10 for lamp circuit only. |
| 1 -- 4 | 1 -- 4 | |
| 2 -- 5 | 2 -- 5 | |
| 3 -- 6 | 3 -- 6 | |
| | 10 -- 9 | |

| Position: | 1 | 2 | 3 |
|-----------|--------------|---------------------|--------------|
| SP DP | 2 & 3, 5 & 6 | Connected Terminals | 1 & 2, 4 & 5 |
| 1 A | ON | NONE | OFF |
| 4 D | ON | NONE | ON |
| 6 J | ON | OFF | ON |
| 7 K | ON | OFF | (ON) |
| 8 L | (ON) | OFF | (ON) |
| 9 N | OFF | NONE | ON |

| SPECIAL CIRCUITS | 2 & 3 | 2 & 3, 5 & 4 | 5 & 4 |
|------------------|----------------|--------------|-------|
| H* | 2 & 3 | 2 & 3, 5 & 4 | 5 & 4 |
| G* | 2 & 3, 5 & 6 | 2 & 3 | OFF |
| S* | 2 & 3, 5 & 6 | 2 & 3 | 1 & 2 |
| M* | (2 & 3, 5 & 6) | 2 & 3 | OFF |
| R* | (2 & 3, 5 & 6) | 2 & 3 | 2 & 1 |
| E* | 5 & 6 | 5 & 3 | 5 & 1 |

*Jumper between terminals 2 & 5 for circuits H,G,M,R & S are specified in selection 4. External jumper between terminals 2 & 4 for circuit E are provided by customer. Circuit E may be used for SP OFF-ON-ON circuit.

3. RATING

| | |
|---|---|
| 1 | .4VA @ 28VDC Resistive |
| 5 | 10A 250VAC 1/2 HP, 15A 125 VAC 1/2 HP, UL Recog., CSA Certified |
| B | 15A 24V |
| C | 20A 18V |
| D | 20A 12V |
| E | 20A 14V, 10A 14VT (circuit 1, 4, A & D only) |
| F | 10A 14V, 6A 14VT (circuit G only) |

4. TERMINATION / BASE STYLE

| 8 term | 10 Term | Termination | Jumper |
|--------|---------|-----------------------------|-------------|
| 1 | 2 | .250 TAB (QC) no barriers | No |
| A | B | .250 TAB (QC) with barriers | No |
| J | K | .250 TAB (QC) no barriers | Yes T2 to 5 |
| 3 | 4 | Solder Lug no barriers | No |
| C | D | Solder Lug | No |
| 5 | 6 | Wire Leads no barriers | No |
| E | F | Wire Leads | No |

Note: Codes J & K for circuits H, G & M. Do not use silicone based lubricants to reduce terminal insertion forces during connector assembly, as it is detrimental to function and performance.

5. ILLUMINATION & SWITCH SEALING

3 & 6 end of switch. Positive (+) and negative (-) symbols apply to LED lamps only

| Sealed Lamps | ILLUMINATION Type | Lamp wired to Terminals |
|---------------------------|-------------------|-------------------------|
| S NONE | - | - |
| C 2 | UP | 3 (+) 7 (-) |
| H 2 | INDEPENDENT | 8 (+) 7 (-) |
| DOUBLE POLE SWITCHES ONLY | | |
| M 1 | UP | 3 (+) 6 (-) |
| 2 | DOWN | 1 (+) 4 (-) |
| P 1 | UP | 1 (+) 4 (-) |
| 2 | UP | 3 (+) 6 (-) |

6. LOCK

Lock above terminals 1 & 4 end of switch
W lock

7. LAMP

Lamp above terminals 3 & 6 end of switch

| | | | |
|---------|---|----------|----------|
| No lamp | 0 | 1 125VAC | 2 250VAC |
| Neon | | | |

LED*

| | | | | |
|-------|-----|-------|-------------------|-----------------|
| 2VDC | Red | Amber | superbright Green | superbright Red |
| 12VDC | A | L | F | R |
| 24VDC | C | N | H | T |
| | D | P | J | V |

* Consult factory for "daylight bright" LED options. Typical current draw for LED is 20ma.

8. FLUSH BRACKET COLOR, PANEL SEAL

| | |
|----------|-------|
| No Seal | Black |
| One Seal | B |
| | C |

9. HARD SURFACE ACTUATOR

| | | |
|-------------|-------|-----|
| Contura II | Black | Red |
| | A | G |
| Contura III | C | E |

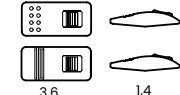
Actuator orientation above terminals: 

10. LENS

| | |
|-------------|-------|
| Z - No Lens | |
| Clear | White |
| 3 | B |
| | D |
| | J |
| | P |
| | V |

Amber Green Red Blue

Green or blue lenses are not recommended with Neon lamps.

11. ACTUATOR LOCK FUNCTION AND COLOR

| Lock Color | Up | Down | Up & Down | Center ³ |
|----------------|----|------|-----------|---------------------|
| Match Actuator | A | H | R | 1 |
| Black | B | J | S | 2 |
| White | C | K | T | 3 |
| Red | D | L | V | 4 |
| Safety Orange | E | M | W | 5 |

12. ACTUATOR LENS OR BODY LEGENDS

| | |
|----------------|-------|
| 00 - No Legend | |
| 21 OFF | 22 ON |
| 23 O | 24 I |
| 25 O | 26 O |
| F | N |
| F | |

For additional legend options & codes, visit us at www.carlingtech.com

13. LEGEND ORIENTATION

| | |
|---|---|
| 0 | No Legend (used with codes 21-28 in selection 12) |
| 1 | Orientation 1 |
| 2 | Orientation 2 |
| 3 | Orientation 3 |
| 4 | Orientation 4 |

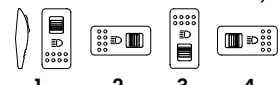

Notes: Consult factory to verify horsepower rating for your particular circuit choice.

- 1 Custom colors are available. Consult factory.
- 2 White imprinting is standard on black actuators; Black imprinting is standard on white, red and gray actuators. Custom colors are available, consult factory.
- 3 Only available with 3 position circuits. Center OFF and special circuits only available with center position lock function.
- 4 Additional ratings available. See V-Series Switch Accessories page.

[Configure Complete Part Number >](#) [Browse Standard Parts >](#)

Ordering Scheme

Contura IV

Sample Part Number

V 1 D A B T 0 B - E P C 00 - 0 00

Selection 1 2 3 4 5 6 7 8 9 10 11 12 13 14

1. SERIES

V V-Series

2. CIRCUIT

Terminal Connections as viewed () - momentary from bottom of switch: SP - single pole: terminals 1, 2 & 3.
8 terminal **10 terminal** DP - double pole: terminals 1, 2, 3, 4, 5 & 6.
 Terminals 7, 8, 9 & 10 for lamp circuit only.

| Position: | 1 | 2 | 3 |
|-----------|--------------|-----------|------------------------|
| SP DP | 2 & 3, 5 & 6 | Connected | Terminals 1 & 2, 4 & 5 |
| 1 A | ON | NONE | OFF |
| 2 B | (ON) | NONE | OFF |
| 3 C | ON | NONE | (OFF) |
| 4 D | ON | NONE | ON |
| 5 F | ON | NONE | (ON) |
| 6 J | ON | OFF | (ON) |
| 7 K | ON | OFF | (ON) |
| 8 L | (ON) | OFF | (ON) |

| SPECIAL CIRCUITS | 1 | 2 | 3 |
|------------------|----------------|--------------|-------|
| H* | 2 & 3 | 2 & 3, 5 & 4 | 5 & 4 |
| G* | 2 & 3, 5 & 6 | 2 & 3 | OFF |
| S* | 2 & 3, 5 & 6 | 2 & 3 | 1 & 2 |
| M* | (2 & 3, 5 & 6) | 2 & 3 | OFF |
| R* | (2 & 3, 5 & 6) | 2 & 3 | 2 & 1 |
| E* | 5 & 6 | 5 & 3 | 5 & 1 |

*Jumper between terminals 2 & 5 for circuits H,G,M,R & S are specified in selection 4. External jumper between terminals 2 & 4 for circuit E are provided by customer. Circuit E may be used for SP OFF-ON-ON circuit.

3. RATING 4

| | |
|---|---|
| 1 | .4VA @ 28VDC Resistive |
| 5 | 10A 250VAC 1/2 HP, 15A 125 VAC 1/2 HP, UL Recog., CSA Certified |
| B | 15A 24V |
| C | 20A 18V |
| D | 20A 12V |
| E | 20A 14V, 10A 14VT (circuit 1, 4, A & D only) |
| F | 10A 14V, 6A 14VT (circuit G only) |

4. TERMINATION / BASE STYLE

| 8 term | 10 Term | Termination | Jumper |
|--------|---------|-----------------------------|-------------|
| 1 | 2 | .250 TAB (QC) no barriers | No |
| A | B | .250 TAB (QC) with barriers | No |
| J | K | .250 TAB (QC) no barriers | Yes T2 to 5 |
| 3 | 4 | Solder Lug no barriers | No |
| C | D | Solder Lug | No |
| 5 | 6 | Wire Leads no barriers | No |
| E | F | Wire Leads | No |

Note: Codes J & K for circuits H, G & M. Do not use silicone based lubricants to reduce terminal insertion forces during connector assembly, as it is detrimental to function and performance.

5. ILLUMINATION & SWITCH SEALING

Lamp #1: above terminals 1 & 4 end of switch.; Lamp #2 above terminals 3 & 6 end of switch. Positive (+) and negative (-) symbols apply to LED lamps only

| Sealed | Lamps | illumination Type | Lamp wired to Terminals |
|--------|-------|-------------------|-------------------------|
| S | NONE | | |
| A | 1 | INDEPENDENT | 8 (+) 7 (-) |
| B | 1 | DOWN | 3 (+) 7 (-) |
| C | 2 | UP | 3 (+) 7 (-) |
| D | 1 | DOWN | 3 (+) 7 (-) |
| E | 2 | DOWN | 1 (+) 7 (-) |
| F | 1 | UP | 1 (+) 7 (-) |
| G | 2 | UP | 3 (+) 7 (-) |
| H | 1 | INDEPENDENT | 8 (+) 7 (-) |
| I | 2 | UP | 3 (+) 7 (-) |
| J | 1 | INDEPENDENT | 8 (+) 7 (-) |
| K | 2 | UP | 3 (+) 7 (-) |
| L | 1 | INDEPENDENT | 8 (+) 7 (-) |
| M | 2 | UP | 3 (+) 7 (-) |
| N | 1 | INDEPENDENT | 8 (+) 7 (-) |
| O | 2 | UP | 3 (+) 7 (-) |
| P | 1 | INDEPENDENT | 8 (+) 7 (-) |
| Q | 2 | UP | 3 (+) 7 (-) |

6,7. LAMP (SAME CODING FOR BOTH SELECTIONS)

Selection 6: above terminals 1 & 4; Selection 7: above terminals 3 & 6

| | | | | |
|---------|---|--------|-------|-------------------------|
| No lamp | 0 | | | |
| Neon | 1 | 125VAC | 2 | 250VAC |
| LED* | | | | superbright superbright |
| | | Red | Amber | Green Red |
| 2VDC | A | L | F | R |
| 12VDC | C | N | H | T |
| 24VDC | D | P | J | V |

* Consult factory for "daylight bright" LED options. Typical current draw for LED is 20ma.

8. FLUSH BRACKET COLOR, PANEL SEAL 1

| | |
|----------|-------|
| No Seal | Black |
| One Seal | B |
| | C |

9. ACTUATOR

| | | |
|---|---|---|
| E | Contura IV, left orientation |  |
| T | Contura IV, left orientation, laser etched | |
| F | Contura IV, right orientation | |
| R | Contura IV, right orientation, laser etched | |

Actuator orientation over terminals:

10. LENS

| 0 - No Actuator | Z - No Lens |
|-----------------------------|-------------|
| Clear White Amber Green Red | Blue |
| 1 6 B G M T | |
| 2 7 C H N U | |
| 3 8 D J P V | |
| 4 9 E K R W | |
| 5 A F L S Y | |



Lens color for LEDs must be clear, white, or match color of LED. Green or blue lenses are not recommended with Neon lamps.

11. ACTUATOR COLOR 1, 5, 6

| | | | | | |
|-------------|---|--------|---|-----|---|
| No Actuator | 0 | Black | C | Red | S |
| Nickel | D | Pewter | E | | |

12. ACTUATOR LENS OR BODY LEGENDS 2

| | | | | | | | |
|----|-----|----|-----|----|-----|----|-----|
| 11 | ON | 12 | OFF | 13 | I | 14 | O |
| | OFF | | ON | | O | | I |
| 15 | O O | 16 | O O | 17 | O I | 18 | I O |
| | F N | | N F | | F | | F |



For additional legend options & codes, visit us at www.carlingtech.com

13. LEGENDS ORIENTATION

| | |
|---|---|
| 0 | No legend (used with codes 11-18 in selection 12) |
| 1 | Orientation 1 |
| 2 | Orientation 2 |
| 3 | Orientation 3 |
| 4 | Orientation 4 |

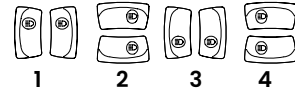

13. ACTUATOR LENS LEGENDS

00 No legend this location / no actuator (used with codes 11-18 in selection 12) Selection 14 required when switch requires two legends. If the two legends consist of one lens and one body legend, lens legend must be specified in selection 12; body legend specified in selection 14. For legend options & codes, visit us at www.carlingtech.com.

Notes:

- Consult factory to verify horsepower rating for your particular circuit choice.
- Custom colors are available. Consult factory.
- White imprinting is standard on black actuators; Black imprinting is standard on white, red and gray actuators. Custom colors are available, consult factory.
- Gloss brow is on left side of E actuator and right side of F actuator.
- Additional ratings available. See V-Series Switch Accessories page.
- Laser etched rocker only available with lenses code Z & actuator colors black, nickel or pewter.
- Pewter and nickel colors only available with laser etched actuator.

[Configure Complete Part Number >](#)

[Browse Standard Parts >](#)

Ordering Scheme

Contura V

Sample Part Number

V 1 D A B T 0 B - G P C 00 - 0 00

Selection

1 2 3 4 5 6 7 8 9 10 11 12 13 14

1. SERIES

V V-Series

2. CIRCUIT

Terminal Connections as viewed () - momentary from bottom of switch: SP - single pole: terminals 1, 2 & 3.
 8 terminal 10 terminal DP - double pole: terminals 1, 2, 3, 4, 5 & 6.
 8 -- 7 8 -- 7 Terminals 7, 8, 9 & 10 for lamp circuit only.
 1 -- 4 1 -- 4
 2 -- 5 2 -- 5
 3 -- 6 3 -- 6
 10 -- 9

| Position: | 1 | 2 | 3 |
|-----------|--------------|---------------------|--------------|
| SP DP | 2 & 3, 5 & 6 | Connected Terminals | 1 & 2, 4 & 5 |
| 1 A | ON | NONE | OFF |
| 2 B | (ON) | NONE | OFF |
| 3 C | ON | NONE | (OFF) |
| 4 D | ON | NONE | ON |
| 5 F | ON | NONE | (ON) |
| 6 J | ON | OFF | ON |
| 7 K | ON | OFF | (ON) |
| 8 L | (ON) | OFF | (ON) |

SPECIAL CIRCUITS

| | | | |
|----|----------------|--------------|-------|
| H* | 2 & 3 | 2 & 3, 5 & 4 | 5 & 4 |
| G* | 2 & 3, 5 & 6 | 2 & 3 | OFF |
| S* | 2 & 3, 5 & 6 | 2 & 3 | 1 & 2 |
| M* | (2 & 3, 5 & 6) | 2 & 3 | OFF |
| R* | (2 & 3, 5 & 6) | 2 & 3 | 2 & 1 |
| E* | 5 & 6 | 5 & 3 | 5 & 1 |

*Jumper between terminals 2 & 5 for circuits H,G,M,R & S are specified in selection 4. External jumper between terminals 2 & 4 for circuit E are provided by customer. Circuit E may be used for SP OFF-ON-ON circuit.

3. RATING

4

| | |
|---|---|
| 1 | .4VA @ 28VDC Resistive |
| 5 | 10A 250VAC 1/2 HP, 15A 125 VAC 1/2 HP, UL Recog., CSA Certified |
| B | 15A 24V |
| C | 20A 18V |
| D | 20A 12V |
| E | 20A 14V, 10A 14VT (circuit 1, 4, A & D only) |
| F | 10A 14V, 6A 14VT (circuit G only) |

4. TERMINATION / BASE STYLE

| 8 term | 10 Term | Termination | Jumper |
|--------|---------|-----------------------------|-------------|
| 1 | 2 | .250 TAB (QC) no barriers | No |
| A | B | .250 TAB (QC) with barriers | No |
| J | K | .250 TAB (QC) no barriers | Yes T2 to 5 |
| 3 | 4 | Solder Lug no barriers | No |
| C | D | Solder Lug | No |
| 5 | 6 | Wire Leads no barriers | No |
| E | F | Wire Leads | No |

Note: Codes J & K for circuits H, G & M. Do not use silicone based lubricants to reduce terminal insertion forces during connector assembly, as it is detrimental to function and performance.

5. ILLUMINATION & SWITCH SEALING

Lamp #1: above terminals 1 & 4 end of switch.; Lamp #2 above terminals 3 & 6 end of switch. Positive (+) and negative (-) symbols apply to LED lamps only

| Sealed | Lamps | illumination Type | Lamp wired to Terminals |
|---------------------------|-------|-------------------|-------------------------|
| S | NONE | - | - |
| A | 1 | INDEPENDENT | 8 (+) 7 (-) |
| B | 1 | DOWN | 3 (+) 7 (-) |
| C | 2 | UP | 3 (+) 7 (-) |
| D | 1 | DOWN | 3 (+) 7 (-) |
| | 2 | DOWN | 1 (+) 7 (-) |
| E | 1 | UP | 1 (+) 7 (-) |
| | 2 | UP | 3 (+) 7 (-) |
| F | 1 | INDEPENDENT | 8 (+) 7 (-) |
| | 2 | UP | 3 (+) 6 (-) |
| G | 1 | INDEPENDENT | 8 (+) 7 (-) |
| | 2 | UP | 3 (+) 7 (-) |
| H | 2 | INDEPENDENT | 8 (+) 7 (-) |
| U | 1 | INDEPENDENT | 8 (+) 7 (-) |
| | 2 | INDEPENDENT | 10 (+) 9 (-) |
| SINGLE POLE SWITCHES ONLY | | | |
| J | 1 | DOWN | 3 (+) 8 (-) |
| | 2 | INDEPENDENT | 6 (+) 7 (-) |
| K | 1 | INDEPENDENT | 8 (+) 7 (-) |
| | 2 | INDEPENDENT | 6 (+) 7 (-) |
| DOUBLE POLE SWITCHES ONLY | | | |
| L | 1 | DOWN | 3 (+) 6 (-) |
| M | 1 | UP | 3 (+) 6 (-) |
| N | 1 | DOWN | 3 (+) 6 (-) |
| | 2 | DOWN | 1 (+) 4 (-) |
| P | 1 | UP | 1 (+) 4 (-) |
| | 2 | UP | 3 (+) 6 (-) |

6,7. LAMP

Selection 6: above terminals 1 & 4; Selection 7: above terminals 3 & 6
 No lamp 0
 Neon 1 125VAC 2 250VAC

| LED* | Red | Amber | superbright Green | superbright Red |
|-------|-----|-------|-------------------|-----------------|
| 2VDC | A | L | F | R |
| 12VDC | C | N | H | T |
| 24VDC | D | P | J | V |

* Consult factory for "daylight bright" LED options. Typical current draw for LED is 20ma.

8. FLUSH BRACKET COLOR, PANEL SEAL

1

| | |
|----------|-------|
| No Seal | Black |
| One Seal | B |
| | C |

9. ACTUATOR

| | |
|---|-------------------------|
| 0 | No Actuator |
| G | Contura V |
| P | Contura V, laser etched |

10. LENS

0 - No Actuator Z - No Lens style & location: #1 / #2
 Clear White Amber Green Red Blue

| | | | | | | |
|---|---|---|---|---|---|--|
| 1 | 6 | B | G | M | T | |
| 2 | 7 | C | H | N | U | |
| 3 | 8 | D | J | P | V | |
| 4 | 9 | E | K | R | W | |
| 5 | A | F | L | S | Y | |

Lens color for LEDs must be clear, white, or match color of LED. Green or blue lenses are not recommended with Neon lamps.

11. ACTUATOR COLOR

1, 3, 5

| | | | | | |
|-------------|---|--------|---|-----|---|
| No Actuator | 0 | Black | C | Red | S |
| Nickel | D | Pewter | E | | |

12. ACTUATOR LENS OR BODY LEGENDS

2, 6

| | | | | | | | |
|----|-----|----|-----|----|-----|----|-----|
| 11 | ON | 12 | OFF | 13 | I | 14 | O |
| | OFF | | ON | | O | | I |
| 15 | O O | 16 | O O | 17 | O I | 18 | I O |
| | F N | | N F | | | | |
| | F | | F | | | | |

For additional legend options & codes, visit us at www.carlingtech.com

12. LEGENDS ORIENTATION

0 No legend (used with codes 11-18 in selection 12)

| | | |
|---|---------------|--|
| 1 | Orientation 1 | |
| 2 | Orientation 2 | |
| 3 | Orientation 3 | |
| 4 | Orientation 4 | |

13. ACTUATOR LENS LEGEND

00 No legend this location / no actuator (used with codes 11-18 in selection 12) Selection 14 required when switch requires two legends. If the two legends consist of one lens and one body legend, lens legend must be specified in selection 12; body legend specified in selection 14.
 For legend options & codes, visit us at www.carlingtech.com

Notes:

- Consult factory to verify horsepower rating for your particular circuit choice.
- Custom colors are available. Consult factory.
- White imprinting is standard on black actuators; Black imprinting is standard on white, red and gray actuators. Custom colors are available, consult factory.
- Laser Etched rocker only available with lens code Z & actuator colors black, nickel or pewter.
- Additional ratings available. See V-Series Switch Accessories page.
- Nickel and Pewter colors only available with laser etched actuator.
- Consult factory for laser etched lens callout.

[Configure Complete Part Number >](#)

[Browse Standard Parts >](#)

Ordering Scheme

Contura IV & V Locking

Sample Part Number

V 1 D A S W 0 B - J Z E 00 - 0

Selection

1 2 3 4 5 6 7 8 9 10 11 12 13

1. SERIES

V V-Series

2. CIRCUIT 3

Terminal Connections as viewed () - momentary from bottom of switch: SP - single pole: terminals 1, 2 & 3. 8 terminal 10 terminal DP - double pole: terminals 1, 2, 3, 4, 5 & 6. 8 -- 7 8 -- 7Terminals 7, 8, 9 & 10 for lamp circuit only.

1 - 4 1 - 4
2 - 5 2 - 5
3 - 6 3 - 6
10 - 9

| Position: | 1 | 2 | 3 |
|-----------|--------------|---------------------|--------------|
| SP DP | 2 & 3, 5 & 6 | Connected Terminals | 1 & 2, 4 & 5 |
| 1 A | ON | NONE | OFF |
| 4 D | ON | NONE | ON |
| 6 J | ON | OFF | ON |
| 7 K | ON | OFF | (ON) |
| 8 L | (ON) | OFF | (ON) |
| 9 N | OFF | NONE | ON |

3. RATING 4

| | |
|---|---|
| 1 | .4VA @ 28VDC Resistive |
| 5 | 10A 250VAC 1/2 HP, 15A 125 VAC 1/2 HP, UL Recog., CSA Certified |
| B | 15A 24V |
| C | 20A 18V |
| D | 20A 12V |
| E | 20A 14V, 10A 14VT (circuit 1, 4, A & D only) |
| F | 10A 14V, 6A 14VT (circuit G only) |

4. TERMINATION / BASE STYLE

| 8 term | 10 Term | Termination | Jumper |
|--------|---------|-----------------------------|-------------|
| 1 | 2 | .250 TAB (QC) no barriers | No |
| A | B | .250 TAB (QC) with barriers | No |
| J | K | .250 TAB (QC) no barriers | Yes T2 to 5 |
| 3 | 4 | Solder Lug no barriers | No |
| C | D | Solder Lug | No |
| 5 | 6 | Wire Leads no barriers | No |
| E | F | Wire Leads | No |

Note: Codes J & K for circuits H, G & M. Do not use silicone based lubricants to reduce terminal insertion forces during connector assembly, as it is detrimental to function and performance.

5. ILLUMINATION & SWITCH SEALING

Lamp #1: above terminals 1 & 4 end of switch.; Lamp #2 above terminals 3 & 6 end of switch. Positive (+) and negative (-) symbols apply to LED lamps only

| Sealed | Lamps | illumination Type | Lamp wired to Terminals |
|---------------------------|-------|-------------------|-------------------------|
| S | NONE | - | - |
| C | 2 | UP | 3 (+) 7 (-) |
| H | 2 | INDEPENDENT | 8 (+) 7 (-) |
| DOUBLE POLE SWITCHES ONLY | | | |
| M | 1 | UP | 3 (+) 6 (-) |

6. LOCK

Lock above terminals 1 & 4 end of switch.
W low profile lock Y⁶ high profile lock

Notes: Consult factory to verify horsepower rating for your particular circuit choice.

- Custom colors are available. Consult factory.
- White imprinting is standard on black actuators; Black imprinting is standard on white, red and gray actuators. Custom colors are available, consult factory.
- Only available with 3 position circuits. Center OFF and special circuits only available with center position lock function.
- Additional ratings available. See V-Series Switch Accessories page.
- Located at T3-6 end of switch.
- Contura V style only.

Configure Complete Part Number >

Browse Standard Parts >

7. LAMP

Lamp above terminals 3 & 6 end of switch

No lamp 0
Neon 1 125VAC 2 250VAC

LED*
2VDC Red A Amber L superbright Green F superbright Red R
12VDC C N H T
24VDC D P J V

* Consult factory for "daylight bright" LED options. Typical current draw for LED is 20ma.

8. FLUSH BRACKET COLOR, PANEL SEAL 1

No Seal Black
One Seal B
C

9. HARD SURFACE ACTUATOR

CONTURA IV:
Orientation Black Red
Left J L
Right N R



Actuator orientation over terminals: 3,6 1,4

CONTURA V:
Black Red
U W



Actuator orientation over terminals: 3,6 1,4

10. LENS 5

Z - No Lens
Clear White Amber Green Red Blue
A B C D E F bar lens
G H J K L M oval lens

Lens color for LEDs must be clear, white, or match color of LED. Green or blue lenses are not recommended with Neon lamps.

11. ACTUATOR LOCK FUNCTION AND COLOR 1

| Lock Color | Up | Down | Up & Down | Center ³ |
|----------------|----|------|-----------|---------------------|
| Match Actuator | A | H | R | 1 |
| Black | B | J | S | 2 |
| White | C | K | T | 3 |
| Red | D | L | V | 4 |
| Safety Orange | E | M | W | 5 |
| Gray | F | G | N | 6 |

12. ACTUATOR LENS OR BODY LEGENDS 2

00 - No Legend
21 22 23 24
OFF ON O I
25 O 26 O 27 O 28 I
F N



For additional legend options & codes, visit us at www.carlingtech.com

13. LEGENDS ORIENTATION

0 No legend
1 Orientation 1
2 Orientation 2
3 Orientation 3
4 Orientation 4



1 2 3 4

Ordering Scheme

Contura X, XI & XII

Sample Part Number

V 1 D A B 6 0 1 - 6 P Z 00 - 0 00

Selection

1 2 3 4 5 6 7 8 9 10 11 12 13 14

1. SERIES

V V-Series

2. CIRCUIT

Terminal Connections as viewed () - momentary from bottom of switch: SP - single pole: terminals 1, 2 & 3.
8 terminal 10 terminal DP - double pole: terminals 1, 2, 3, 4, 5 & 6.
 8 -- 7 8 -- 7 Terminals 7, 8, 9 & 10 for lamp circuit only.
 1 - 4 1 - 4
 2 - 5 2 - 5
 3 - 6 3 - 6
 10 - 9

| Position: | 1 | 2 | 3 |
|-----------|-------|------|--------------|
| SP | 2 & 3 | 2 | 1 & 2, 4 & 5 |
| DP | 5 & 6 | 3 | 2, 4 & 5 |
| A | (ON) | NONE | OFF |
| B | (ON) | NONE | OFF |
| C | (ON) | NONE | OFF |
| D | (ON) | NONE | OFF |
| E | (ON) | NONE | OFF |
| F | (ON) | NONE | OFF |
| G | (ON) | NONE | OFF |
| H | (ON) | NONE | OFF |
| I | (ON) | NONE | OFF |
| J | (ON) | NONE | OFF |
| K | (ON) | NONE | OFF |
| L | (ON) | NONE | OFF |
| M | (ON) | NONE | OFF |
| N | (ON) | NONE | OFF |
| O | (ON) | NONE | OFF |
| P | (ON) | NONE | OFF |
| Q | (ON) | NONE | OFF |
| R | (ON) | NONE | OFF |
| S | (ON) | NONE | OFF |
| T | (ON) | NONE | OFF |
| U | (ON) | NONE | OFF |
| V | (ON) | NONE | OFF |
| W | (ON) | NONE | OFF |
| X | (ON) | NONE | OFF |
| Y | (ON) | NONE | OFF |
| Z | (ON) | NONE | OFF |
| AA | (ON) | NONE | OFF |
| AB | (ON) | NONE | OFF |
| AC | (ON) | NONE | OFF |
| AD | (ON) | NONE | OFF |
| AE | (ON) | NONE | OFF |
| AF | (ON) | NONE | OFF |
| AG | (ON) | NONE | OFF |
| AH | (ON) | NONE | OFF |
| AI | (ON) | NONE | OFF |
| AJ | (ON) | NONE | OFF |
| AK | (ON) | NONE | OFF |
| AL | (ON) | NONE | OFF |
| AM | (ON) | NONE | OFF |
| AN | (ON) | NONE | OFF |
| AO | (ON) | NONE | OFF |
| AP | (ON) | NONE | OFF |
| AQ | (ON) | NONE | OFF |
| AR | (ON) | NONE | OFF |
| AS | (ON) | NONE | OFF |
| AT | (ON) | NONE | OFF |
| AU | (ON) | NONE | OFF |
| AV | (ON) | NONE | OFF |
| AW | (ON) | NONE | OFF |
| AX | (ON) | NONE | OFF |
| AY | (ON) | NONE | OFF |
| AZ | (ON) | NONE | OFF |
| BA | (ON) | NONE | OFF |
| BB | (ON) | NONE | OFF |
| BC | (ON) | NONE | OFF |
| BD | (ON) | NONE | OFF |
| BE | (ON) | NONE | OFF |
| BF | (ON) | NONE | OFF |
| BG | (ON) | NONE | OFF |
| BH | (ON) | NONE | OFF |
| BI | (ON) | NONE | OFF |
| BJ | (ON) | NONE | OFF |
| BK | (ON) | NONE | OFF |
| BL | (ON) | NONE | OFF |
| BM | (ON) | NONE | OFF |
| BN | (ON) | NONE | OFF |
| BO | (ON) | NONE | OFF |
| BP | (ON) | NONE | OFF |
| BQ | (ON) | NONE | OFF |
| BR | (ON) | NONE | OFF |
| BS | (ON) | NONE | OFF |
| BT | (ON) | NONE | OFF |
| BU | (ON) | NONE | OFF |
| BV | (ON) | NONE | OFF |
| BW | (ON) | NONE | OFF |
| BX | (ON) | NONE | OFF |
| BY | (ON) | NONE | OFF |
| BZ | (ON) | NONE | OFF |
| CA | (ON) | NONE | OFF |
| CB | (ON) | NONE | OFF |
| CC | (ON) | NONE | OFF |
| CD | (ON) | NONE | OFF |
| CE | (ON) | NONE | OFF |
| CF | (ON) | NONE | OFF |
| CG | (ON) | NONE | OFF |
| CH | (ON) | NONE | OFF |
| CI | (ON) | NONE | OFF |
| CJ | (ON) | NONE | OFF |
| CK | (ON) | NONE | OFF |
| CL | (ON) | NONE | OFF |
| CM | (ON) | NONE | OFF |
| CN | (ON) | NONE | OFF |
| CO | (ON) | NONE | OFF |
| CP | (ON) | NONE | OFF |
| CQ | (ON) | NONE | OFF |
| CR | (ON) | NONE | OFF |
| CS | (ON) | NONE | OFF |
| CT | (ON) | NONE | OFF |
| CU | (ON) | NONE | OFF |
| CV | (ON) | NONE | OFF |
| CW | (ON) | NONE | OFF |
| CX | (ON) | NONE | OFF |
| CY | (ON) | NONE | OFF |
| CZ | (ON) | NONE | OFF |
| DA | (ON) | NONE | OFF |
| DB | (ON) | NONE | OFF |
| DC | (ON) | NONE | OFF |
| DD | (ON) | NONE | OFF |
| DE | (ON) | NONE | OFF |
| DF | (ON) | NONE | OFF |
| DG | (ON) | NONE | OFF |
| DH | (ON) | NONE | OFF |
| DI | (ON) | NONE | OFF |
| DJ | (ON) | NONE | OFF |
| DK | (ON) | NONE | OFF |
| DL | (ON) | NONE | OFF |
| DM | (ON) | NONE | OFF |
| DN | (ON) | NONE | OFF |
| DO | (ON) | NONE | OFF |
| DP | (ON) | NONE | OFF |
| DQ | (ON) | NONE | OFF |
| DR | (ON) | NONE | OFF |
| DS | (ON) | NONE | OFF |
| DT | (ON) | NONE | OFF |
| DU | (ON) | NONE | OFF |
| DV | (ON) | NONE | OFF |
| DW | (ON) | NONE | OFF |
| DX | (ON) | NONE | OFF |
| DY | (ON) | NONE | OFF |
| DZ | (ON) | NONE | OFF |
| EA | (ON) | NONE | OFF |
| EB | (ON) | NONE | OFF |
| EC | (ON) | NONE | OFF |
| ED | (ON) | NONE | OFF |
| EE | (ON) | NONE | OFF |
| EF | (ON) | NONE | OFF |
| EG | (ON) | NONE | OFF |
| EH | (ON) | NONE | OFF |
| EI | (ON) | NONE | OFF |
| EJ | (ON) | NONE | OFF |
| EK | (ON) | NONE | OFF |
| EL | (ON) | NONE | OFF |
| EM | (ON) | NONE | OFF |
| EN | (ON) | NONE | OFF |
| EO | (ON) | NONE | OFF |
| EP | (ON) | NONE | OFF |
| EQ | (ON) | NONE | OFF |
| ER | (ON) | NONE | OFF |
| ES | (ON) | NONE | OFF |
| ET | (ON) | NONE | OFF |
| EU | (ON) | NONE | OFF |
| EV | (ON) | NONE | OFF |
| EW | (ON) | NONE | OFF |
| EX | (ON) | NONE | OFF |
| EY | (ON) | NONE | OFF |
| EZ | (ON) | NONE | OFF |
| FA | (ON) | NONE | OFF |
| FB | (ON) | NONE | OFF |
| FC | (ON) | NONE | OFF |
| FD | (ON) | NONE | OFF |
| FE | (ON) | NONE | OFF |
| FG | (ON) | NONE | OFF |
| FH | (ON) | NONE | OFF |
| FI | (ON) | NONE | OFF |
| FJ | (ON) | NONE | OFF |
| FK | (ON) | NONE | OFF |
| FL | (ON) | NONE | OFF |
| FM | (ON) | NONE | OFF |
| FN | (ON) | NONE | OFF |
| FO | (ON) | NONE | OFF |
| FP | (ON) | NONE | OFF |
| FQ | (ON) | NONE | OFF |
| FR | (ON) | NONE | OFF |
| FS | (ON) | NONE | OFF |
| FT | (ON) | NONE | OFF |
| FU | (ON) | NONE | OFF |
| FV | (ON) | NONE | OFF |
| FW | (ON) | NONE | OFF |
| FX | (ON) | NONE | OFF |
| FY | (ON) | NONE | OFF |
| FZ | (ON) | NONE | OFF |
| GA | (ON) | NONE | OFF |
| GB | (ON) | NONE | OFF |
| GC | (ON) | NONE | OFF |
| GD | (ON) | NONE | OFF |
| GE | (ON) | NONE | OFF |
| GF | (ON) | NONE | OFF |
| GG | (ON) | NONE | OFF |
| GH | (ON) | NONE | OFF |
| GI | (ON) | NONE | OFF |
| GJ | (ON) | NONE | OFF |
| GK | (ON) | NONE | OFF |
| GL | (ON) | NONE | OFF |
| GM | (ON) | NONE | OFF |
| GN | (ON) | NONE | OFF |
| GO | (ON) | NONE | OFF |
| GP | (ON) | NONE | OFF |
| GQ | (ON) | NONE | OFF |
| GR | (ON) | NONE | OFF |
| GS | (ON) | NONE | OFF |
| GT | (ON) | NONE | OFF |
| GU | (ON) | NONE | OFF |
| GV | (ON) | NONE | OFF |
| GW | (ON) | NONE | OFF |
| GX | (ON) | NONE | OFF |
| GY | (ON) | NONE | OFF |
| GZ | (ON) | NONE | OFF |
| HA | (ON) | NONE | OFF |
| HB | (ON) | NONE | OFF |
| HC | (ON) | NONE | OFF |
| HD | (ON) | NONE | OFF |
| HE | (ON) | NONE | OFF |
| HF | (ON) | NONE | OFF |
| HG | (ON) | NONE | OFF |
| HH | (ON) | NONE | OFF |
| HI | (ON) | NONE | OFF |
| HJ | (ON) | NONE | OFF |
| HK | (ON) | NONE | OFF |
| HL | (ON) | NONE | OFF |
| HM | (ON) | NONE | OFF |
| HN | (ON) | NONE | OFF |
| HO | (ON) | NONE | OFF |
| HP | (ON) | NONE | OFF |
| HQ | (ON) | NONE | OFF |
| HR | (ON) | NONE | OFF |
| HS | (ON) | NONE | OFF |
| HT | (ON) | NONE | OFF |
| HU | (ON) | NONE | OFF |
| HV | (ON) | NONE | OFF |
| HW | (ON) | NONE | OFF |
| HX | (ON) | NONE | OFF |
| HY | (ON) | NONE | OFF |
| HZ | (ON) | NONE | OFF |
| IA | (ON) | NONE | OFF |
| IB | (ON) | NONE | OFF |
| IC | (ON) | NONE | OFF |
| ID | (ON) | NONE | OFF |
| IE | (ON) | NONE | OFF |
| IF | (ON) | NONE | OFF |
| IG | (ON) | NONE | OFF |
| IH | (ON) | NONE | OFF |
| II | (ON) | NONE | OFF |
| IJ | (ON) | NONE | OFF |
| IK | (ON) | NONE | OFF |
| IL | (ON) | NONE | OFF |
| IM | (ON) | NONE | OFF |
| IN | (ON) | NONE | OFF |
| IO | (ON) | NONE | OFF |
| IP | (ON) | NONE | OFF |
| IQ | (ON) | NONE | OFF |
| IR | (ON) | NONE | OFF |
| IS | (ON) | NONE | OFF |
| IT | (ON) | NONE | OFF |
| IU | (ON) | NONE | OFF |
| IV | (ON) | NONE | OFF |
| IW | (ON) | NONE | OFF |
| IX | (ON) | NONE | OFF |
| IY | (ON) | NONE | OFF |
| IZ | (ON) | NONE | OFF |
| JA | (ON) | NONE | OFF |
| JB | (ON) | NONE | OFF |
| JC | (ON) | NONE | OFF |
| JD | (ON) | NONE | OFF |
| JE | (ON) | NONE | OFF |
| JF | (ON) | NONE | OFF |
| JG | (ON) | NONE | OFF |
| JH | (ON) | NONE | OFF |
| JI | (ON) | NONE | OFF |
| JJ | (ON) | NONE | OFF |
| JK | (ON) | NONE | OFF |
| JL | (ON) | NONE | OFF |
| JM | (ON) | NONE | OFF |
| JN | (ON) | NONE | OFF |
| JO | (ON) | NONE | OFF |
| JP | (ON) | NONE | OFF |
| JQ | (ON) | NONE | OFF |
| JR | (ON) | NONE | OFF |
| JS | (ON) | NONE | OFF |
| JT | (ON) | NONE | OFF |
| JU | (ON) | NONE | OFF |
| JV | (ON) | NONE | OFF |
| JW | (ON) | NONE | OFF |
| JX | (ON) | NONE | OFF |
| JY | (ON) | NONE | OFF |
| JZ | (ON) | NONE | OFF |
| KA | (ON) | NONE | OFF |
| KB | (ON) | NONE | OFF |
| KC | (ON) | NONE | OFF |
| KD | (ON) | NONE | OFF |
| KE | (ON) | NONE | OFF |
| KF | (ON) | NONE | OFF |
| KG | (ON) | NONE | OFF |
| KH | (ON) | NONE | OFF |
| KI | (ON) | NONE | OFF |
| KJ | (ON) | NONE | OFF |
| KK | (ON) | NONE | OFF |
| KL | (ON) | NONE | OFF |
| KM | (ON) | NONE | OFF |
| KN | (ON) | NONE | OFF |
| KO | (ON) | NONE | OFF |
| KP | (ON) | NONE | OFF |
| KQ | (ON) | NONE | OFF |
| KR | (ON) | NONE | OFF |
| KS | (ON) | NONE | OFF |
| KT | (ON) | NONE | OFF |
| KU | (ON) | NONE | OFF |
| KV | (ON) | NONE | OFF |
| KW | (ON) | NONE | OFF |
| KX | (ON) | NONE | OFF |
| KY | (ON) | NONE | OFF |
| KZ | (ON) | NONE | OFF |
| LA | (ON) | NONE | OFF |
| LB | (ON) | NONE | OFF |
| LC | (ON) | NONE | OFF |
| LD | (ON) | NONE | OFF |
| LE | (ON) | NONE | OFF |
| LF | (ON) | NONE | OFF |
| LG | (ON) | NONE | OFF |
| LH | (ON) | NONE | OFF |
| LI | (ON) | NONE | OFF |
| LJ | (ON) | NONE | OFF |
| LK | (ON) | NONE | OFF |
| LL | (ON) | NONE | OFF |
| LM | (ON) | NONE | OFF |
| LN | (ON) | NONE | OFF |
| LO | (ON) | NONE | OFF |
| LP | (ON) | NONE | OFF |
| LQ | (ON) | NONE | OFF |
| LR | (ON) | NONE | OFF |
| LS | (ON) | NONE | OFF |
| LT | (ON) | NONE | OFF |
| LU | (ON) | NONE | OFF |

Ordering Scheme

Contura X locking

Sample Part Number **V 1 D A S W 0 1 - 1 P B 00 - 0**

Selection 1 2 3 4 5 6 7 8 9 10 11 12 13

1. SERIES

V V-Series

2. CIRCUIT

Terminal Connections as viewed () - momentary from bottom of switch: SP - single pole: terminals 1, 2 & 3.
8 terminal **10 terminal** DP - double pole: terminals 1, 2, 3, 4, 5 & 6.
 8 -- 7 8 -- 7 Terminals 7, 8, 9 & 10 for lamp circuit only.
 1 -- 4 1 -- 4
 2 -- 5 2 -- 5
 3 -- 6 3 -- 6
 10 -- 9

Position:

| SP DP | 1 | 2 | 3 |
|-------|-----------------|-----------|------------------|
| 1 A | 2 & 3, 5 & 6 ON | Connected | 1 & 2, 4 & 5 OFF |
| 4 D | ON | NONE | ON |
| 6 J | ON | OFF | ON |
| 9 N | OFF | NONE | ON |

SPECIAL CIRCUITS

| H* | G* | S* | E* |
|--------------|--------------|--------------|-------|
| 2 & 3 | 2 & 3, 5 & 6 | 2 & 3, 5 & 6 | 5 & 6 |
| 2 & 3, 5 & 4 | 2 & 3 | 2 & 3 | 5 & 3 |
| 5 & 4 | OFF | 1 & 2 | 5 & 1 |

*Jumper between terminals 2 & 5 for circuits H,G,M,R & S are specified in selection 4. External jumper between terminals 2 & 4 for circuit E are provided by customer. Circuit E may be used for SP OFF-ON-ON circuit.

3. RATING 4

| | |
|---|---|
| 1 | .4VA @ 28VDC Resistive |
| 5 | 10A 250VAC 1/2 HP, 15A 125 VAC 1/2 HP, UL Recog., CSA Certified |
| B | 15A 24V |
| C | 20A 18V |
| D | 20A 12V |
| E | 20A 14V, 10A 14VT (circuit 1, 4, A & D only) |
| F | 10A 14V, 6A 14VT (circuit G only) |

4. TERMINATION / BASE STYLE

| 8 term | 10 Term | Termination | Jumper |
|--------|---------|-----------------------------|-------------|
| 1 | 2 | .250 TAB (QC) no barriers | No |
| A | B | .250 TAB (QC) with barriers | No |
| J | K | .250 TAB (QC) no barriers | Yes T2 to 5 |
| 3 | 4 | Solder Lug no barriers | No |
| C | D | Solder Lug | No |
| 5 | 6 | Wire Leads no barriers | No |
| E | F | Wire Leads | No |

Note: Codes J & K for circuits H, G & M. Do not use silicone based lubricants to reduce terminal insertion forces during connector assembly, as it is detrimental to function and performance.

5. ILLUMINATION & SWITCH SEALING

Lamp #1: above terminals 1 & 4 end of switch; Lamp #2 above terminals 3 & 6 end of switch. Positive (+) and negative (-) symbols apply to LED lamps only

| Sealed | Lamps | illumination Type | Lamp wired to Terminals |
|---------------------------|-------|-------------------|-------------------------|
| S | NONE | - | - |
| C | 2 | UP | 3 (+) 7 (-) |
| H | 2 | INDEPENDENT | 8 (+) 7 (-) |
| DOUBLE POLE SWITCHES ONLY | | | |
| M | 1 | UP | 3 (+) 6 (-) |

6. LOCKS

Lock above terminals 1 & 4 end of switch.
W Lock

Notes: Consult factory to verify horsepower rating for your particular circuit choice.

- 1 Custom colors are available. Consult factory.
- 2 White imprinting is standard on black actuators; Black imprinting is standard on white, red and gray actuators; Custom colors are available, consult factory.
- 3 Located over T1-4 end of switch.
- 4 Additional ratings available. See V-Series Switch Accessories page.
- 5 Located over T3-6 end of switch.

6.7. LAMP (SAME CODING FOR BOTH SELECTIONS)

Selection 6: above terminals 1 & 4; Selection 7: above terminals 3 & 6
 No lamp **0**
 Neon 1 125VAC 2 250VAC

LED*

| | Red | Amber | superbright Green | superbright Red |
|-------|-----|-------|-------------------|-----------------|
| 2VDC | A | L | F | R |
| 12VDC | C | N | H | T |
| 24VDC | D | P | J | V |

* Consult factory for "daylight bright" LED options. Typical current draw for LED is 20ma.

8. FLUSH BRACKET COLOR, PANEL SEAL 1

| | | |
|------------|---|-------|
| No Gasket | 1 | Black |
| One Gasket | 4 | |

9. HARD SURFACE ACTUATOR

| | | |
|-----------|-------|-----|
| Contura X | Black | Red |
| | 1 | 4 |

Actuator orientation over terminals:



10. LENS - ABOVE LAMP #2 TERMINALS 5

Z - No Lens

| Clear | White | Amber | Green | Red | Blue | Lens Style |
|-------|-------|-------|-------|-----|------|---|
| 3 | 8 | D | J | P | V | Bar |
| 4 | 9 | E | K | R | W | One piece Square |
| 5 | A | F | L | S | Y | Two piece Square* (with clear top protective lens) |

* All bottom lenses are molded of opaque material. Consult factory for other lens colors. Lens color for LEDs must be clear, white, or match color of LED. Green or blue lenses are not recommended with Neon lamps.

12. ACTUATOR LOCK FUNCTION 3

| Lock Color | Up | Down | Up & Down |
|----------------|----|------|-----------|
| Match Actuator | A | H | R |
| Black | B | J | S |
| White | C | K | T |
| Red | D | L | V |
| Safety Orange | E | M | W |
| Gray | F | G | N |

13. ACTUATOR LENS OR BODY LEGENDS 2

00 - No Legend
 21 OFF 22 ON 23 O 24 I
 25 O 26 O 27 O 28 I
 F N F



For additional legend options & codes, visit us at www.carlingtech.com

14. LEGEND ORIENTATION 3

0 No legend (used with codes 11-18 in selection 12)
 1 Orientation 1
 2 Orientation 2
 3 Orientation 3
 4 Orientation 4

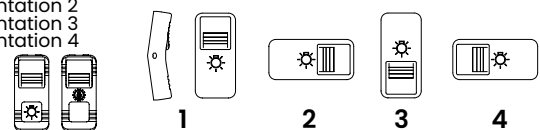

[Configure Complete Part Number >](#)

[Browse Standard Parts >](#)

Ordering Scheme

Contura XIV

Sample Part Number

V 1 D B B C 0 B-FA P C AB- 1 00

Selection 1 2 3 4 5 6 7 8 9 10 11 12 13 14

1. SERIES

V V-Series

2. CIRCUIT

Terminal Connections as viewed () - momentary from bottom of switch: SP - single pole: terminals 1, 2 & 3.
 8 terminal 10 terminal DP - double pole: terminals 1, 2, 3, 4, 5 & 6.
 8 -- 7 8 -- 7 Terminals 7, 8, 9 & 10 for lamp circuit only.
 1 -- 4 1 -- 4
 2 -- 5 2 -- 5
 3 -- 6 3 -- 6
 10 -- 9

| Position: | 1 | 2 | 3 |
|-----------|--------------|---------------------|--------------|
| SP | 2 & 3, 5 & 6 | Connected Terminals | 1 & 2, 4 & 5 |
| 1 A | ON | NONE | OFF |
| 2 B | (ON) | NONE | OFF |
| 3 C | ON | NONE | (OFF) |
| 4 D | ON | NONE | ON |
| 5 F | ON | NONE | (ON) |
| 6 J | ON | OFF | ON |
| 7 K | ON | OFF | (ON) |
| 8 L | (ON) | OFF | (ON) |

| SPECIAL CIRCUITS | 1 | 2 | 3 |
|------------------|----------------|--------------|-------|
| H* | 2 & 3 | 2 & 3, 5 & 4 | 5 & 4 |
| G* | 2 & 3, 5 & 6 | 2 & 3 | OFF |
| M* | (2 & 3, 5 & 6) | 2 & 3 | OFF |
| R* | (2 & 3, 5 & 6) | 2 & 3 | 2 & 1 |
| E* | 5 & 6 | 5 & 3 | 5 & 1 |
| S* | 2 & 3, 5 & 6 | 2 & 3 | 1 & 2 |

*Jumper between terminals 2 & 5 for circuits H,G,M,R & S are specified in selection 4. External jumper between terminals 2 & 4 for circuit E are provided by customer. Circuit E may be used for SP OFF-ON-ON circuit.

3. RATING 3

| | |
|---|---|
| 1 | .4VA @ 28VDC Resistive |
| 5 | 10A 250VAC 1/2 HP, 15A 125 VAC 1/2 HP, UL Recog., CSA Certified |
| B | 15A 24V |
| C | 20A 18V |
| D | 20A 12V |
| E | 20A 14V, 10A 14VT (circuit 1, 4, A & D only) |
| F | 10A 14V, 6A 14VT (circuit G only) |

4. TERMINATION / BASE STYLE

| 8 Term | 10 Term | Termination | Jumper |
|--------|---------|-----------------------------|-------------|
| 1 | 2 | .250 TAB (QC) no barriers | No |
| A | B | .250 TAB (QC) with barriers | No |
| J | K | .250 TAB (QC) no barriers | Yes T2 to 5 |
| 3 | 4 | Solder Lug no barriers | No |
| C | D | Solder Lug | No |
| 5 | 6 | Wire Leads no barriers | No |
| E | F | Wire Leads | No |

Note: Codes J & K for circuits H, G & M. Do not use silicone based lubricants to reduce terminal insertion forces during connector assembly, as it is detrimental to function and performance.

5. ILLUMINATION & SWITCH SEALING

Lamp #1: above terminals 1 & 4 end of switch.; Lamp #2 above terminals 3 & 6 end of switch. Positive (+) and negative (-) symbols apply to LED lamps only

| Lamps | illumination Type | Lamp wired to Terminals |
|-------|-------------------|-------------------------|
| S | NONE | - |
| A | INDEPENDENT | 8 (+) 7 (-) |
| B | DOWN | 3 (+) 7 (-) |
| C | UP | 3 (+) 7 (-) |
| D | DOWN | 3 (+) 7 (-) |
| E | DOWN | 1 (+) 7 (-) |
| F | UP | 1 (+) 7 (-) |
| G | UP | 3 (+) 7 (-) |
| H | INDEPENDENT | 8 (+) 7 (-) |
| I | UP | 3 (+) 7 (-) |
| J | DOWN | 3 (+) 8 (-) |
| K | INDEPENDENT | 6 (+) 7 (-) |
| L | DOWN | 8 (+) 7 (-) |
| M | INDEPENDENT | 6 (+) 7 (-) |
| N | DOWN | 6 (+) 7 (-) |
| P | DOWN | 1 (+) 4 (-) |
| U | UP | 1 (+) 4 (-) |
| | UP | 3 (+) 6 (-) |
| | INDEPENDENT | 8 (+) 7 (-) |
| | INDEPENDENT | 10 (+) 9 (-) |

6 & 7. LAMP

| | | | |
|---------|-----|----------|-------------------|
| No lamp | 0 | 1 125VAC | 2 250VAC |
| LED* | Red | Amber | superbright Green |
| 2VDC | A | L | F |
| 12VDC | C | N | H |
| 24VDC | D | P | J |
| | | | superbright Red |
| | | | R |
| | | | T |
| | | | V |

* Consult factory for "daylight bright" LED options. Typical current draw for LED is 20ma.

8. BRACKET COLOR & PANEL SEAL

| | | | |
|-------|-----------|----------|----------|
| Color | No Gasket | 1 Gasket | 2 Gasket |
| Black | B | C | D |

9. ACTUATOR STYLE

| | |
|----|------------------------------------|
| 0 | No Actuator - Furnished separately |
| FA | Contura XIV |
| FB | Contura XIV - Laser Etched |



10. LENS COLOR / STYLE

| 0 - No Actuator | Z - No Lens | | | | |
|-----------------|-------------|-------|-------|-----|------|
| Clear | White | Amber | Green | Red | Blue |
| 1 | 6 | B | G | M | T |
| 2 | 7 | C | H | N | U |
| 3 | 8 | D | J | P | V |
| 4 | 9 | E | K | R | W |
| 5 | A | F | L | S | Y |
| | A | N/A | N/A | N/A | N/A |

Laser-Etched Actuator

Only Lens color for LEDs must be clear, white, or match color of LED. Green or blue lenses are not recommended with Neon lamps.

11. ACTUATOR COLOR 1

| | |
|---|-------------------|
| 0 | N/A - No Actuator |
| C | Black |
| S | Red |

12. ACTUATOR LENS OR BODY LEGEND 2

00 - No Legend this location / No actuator

| | | | | |
|----|-----|--------|--------|--------|
| 11 | ON | 12 OFF | 13 I | 14 O |
| | OFF | ON | O | I |
| 15 | O O | 16 O O | 17 O I | 18 I O |
| | F N | N F | | |
| | F | F | | |



12. ACTUATOR LENS OR BODY LEGEND

| | | | | | |
|---|---------------|--|--|--|--|
| 0 | No legend | | | | |
| 1 | Orientation 1 | | | | |
| 2 | Orientation 2 | | | | |
| 3 | Orientation 3 | | | | |
| 4 | Orientation 4 | | | | |

12. ACTUATOR LENS OR BODY LEGEND

00 No legend this location / no actuator

(used with codes 11-18 in selection 12) Selection 14 required when switch requires two legends. If the two legends consist of one lens and one body legend, lens legend must be specified in selection 12; body legend specified in selection 14.

For legend options & codes, visit us at www.carlingtech.com.

Notes: Consult factory to verify horsepower rating for your particular circuit choice.

- 1 Custom colors are available. Consult factory.
- 2 White imprinting is standard on black actuators; Black imprinting is standard on white, red and gray actuators.
- 3 Additional ratings available. See V-Series Switch Accessories page.

[Configure Complete Part Number >](#)

[Browse Standard Parts >](#)

Ordering Scheme

Contura XIV Locking

Sample Part Number

V 1 D A B W 0 B-FC Z B 00-0

Selection 1 2 3 4 5 6 7 8 9 10 11 12 13

1. SERIES

V V-Series

2. CIRCUIT

Terminal Connections as viewed () - momentary from bottom of switch: SP - single pole: terminals 1, 2 & 3.
8 terminal **10 terminal** DP - double pole: terminals 1, 2, 3, 4, 5 & 6.
 8 -- 7 8 -- 7 Terminals 7, 8, 9 & 10 for lamp circuit only.
 1 - 4 1 - 4
 2 - 5 2 - 5
 3 - 6 3 - 6
 10 -- 9

| Position: | 1 | 2 | 3 |
|-----------|--------------|---------------------|--------------|
| SP DP | 2 & 3, 5 & 6 | Connected Terminals | 1 & 2, 4 & 5 |
| 1 A | ON | NONE | OFF |
| - B | (ON) | NONE | OFF |
| 4 D | ON | NONE | ON |
| 6 J | ON | OFF | ON |
| 7 K | (ON) | OFF | (ON) |
| 8 L | (ON) | OFF | (ON) |
| 9 N | OFF | NONE | ON |

SPECIAL CIRCUITS

| | | | |
|----|----------------|--------------|-------|
| H* | 2 & 3 | 2 & 3, 5 & 4 | 5 & 4 |
| G* | 2 & 3, 5 & 6 | 2 & 3 | OFF |
| M* | (2 & 3, 5 & 6) | 2 & 3 | OFF |
| R* | (2 & 3, 5 & 6) | 2 & 3 | 2 & 1 |
| E* | 5 & 6 | 5 & 3 | 5 & 1 |
| S* | 2 & 3, 5 & 6 | 2 & 3 | 1 & 2 |

*Jumper between terminals 2 & 5 for circuits H,G,M,R & S are specified in selection 4. External jumper between terminals 2 & 4 for circuit E are provided by customer. Circuit E may be used for SP OFF-ON-ON circuit.

3. RATING

3

| | |
|---|---|
| 1 | .4VA @ 28VDC Resistive |
| 5 | 10A 250VAC 1/2 HP, 15A 125 VAC 1/2 HP, UL Recog., CSA Certified |
| B | 15A 24V |
| C | 20A 18V |
| D | 20A 12V |
| E | 20A 14V, 10A 14VT (circuit 1, 4, A & D only) |
| F | 10A 14V, 6A 14VT (circuit G only) |

4. TERMINATION / BASE STYLE

| 8 Term | 10 Term | Termination | Jumper |
|--------|---------|-----------------------------|-------------|
| 1 | 2 | .250 TAB (QC) no barriers | No |
| A | B | .250 TAB (QC) with barriers | No |
| J | K | .250 TAB (QC) no barriers | Yes T2 to 5 |

Note: Codes J & K for circuits H, G & M. Do not use silicone based lubricants to reduce terminal insertion forces during connector assembly, as it is detrimental to function and performance.

5. ILLUMINATION & SWITCH SEALING

Lamp #1: above terminals 1 & 4 end of switch.; Lamp #2 above terminals 3 & 6 end of switch. Positive (+) and negative (-) symbols apply to LED lamps only

| Lamps | illumination Type | Lamp wired to Terminals |
|-------|-------------------|-------------------------|
| S | NONE | - |
| C | UP | 3 (+) 7 (-) |
| H | INDEPENDENT | 8 (+) 7 (-) |

DOUBLE POLE SWITCHES ONLY

| | | | |
|---|---|----|-------------|
| M | 1 | UP | 3 (+) 6 (-) |
|---|---|----|-------------|

5. LOCK OPTION

W Low Profile Lock

Notes: Consult factory to verify horsepower rating for your particular circuit choice.

- Custom colors are available. Consult factory.
- White imprinting is standard on black actuators; Black imprinting is standard on white, red and gray actuators.
- Additional ratings available. See V-Series Switch Accessories page.

7. LAMP

| | | | |
|---------|-----|--------|-------------------------|
| No lamp | 0 | | |
| Neon | 1 | 125VAC | 2 250VAC |
| LED* | | | superbright superbright |
| | Red | Amber | Green Red |
| 2VDC | A | L | F R |
| 12VDC | C | N | H T |
| 24VDC | D | P | J V |

* Consult factory for "daylight bright" LED options. Typical current draw for LED is 20ma.

8. BRACKET COLOR & PANEL SEAL

| Color | No Gasket | 1 Gasket | 2 Gasket |
|-------|-----------|----------|----------|
| Black | B | C | D |

9. ACTUATOR COLOR / STYLE

| | |
|----|-------------------------|
| FC | Black - Standard Rocker |
| FD | Black - Laser Etched |
| FS | Red - Standard Rocker |
| FT | Red - Laser Etched |



10. LENS COLOR / STYLE

| | | | | | |
|-------|---------|-------|-------|-----|------|
| Z | No Lens | | | | |
| Clear | White | Amber | Green | Red | Blue |
| 1 | 6 | B | G | M | T |
| 3 | 8 | D | J | P | V |
| 5 | A | N/A | N/A | N/A | N/A |

Legend: Laser-Etched Only

Lens color for LEDs must be clear, white, or match color of LED. Green or blue lenses are not recommended with Neon lamps.

11. ACTUATOR LOCK COLOR / FUNCTION

1

| Lock Color | UP | LOCK IN POSITION | | CENTER |
|----------------|----|------------------|-----------|--------|
| | | DOWN | UP & DOWN | |
| Match Actuator | A | H | R | 1 |
| Black | B | J | S | 2 |
| White | C | K | T | 3 |
| Red | D | L | V | 4 |
| Orange | E | M | W | 5 |
| Gray | F | G | N | 6 |

12. ACTUATOR LENS OR BODY LEGENDS

2

| | | | |
|------|-----------|-------|------|
| 00 | No Legend | | |
| 21 | OFF | 22 ON | 23 O |
| | | | 24 I |
| 25 O | 26 O | 27 O | 28 I |
| F | N | | |
| F | | | |



13. LEGEND ORIENTATION

| | |
|---|---------------|
| 0 | No legend |
| 1 | Orientation 1 |
| 2 | Orientation 2 |
| 3 | Orientation 3 |
| 4 | Orientation 4 |

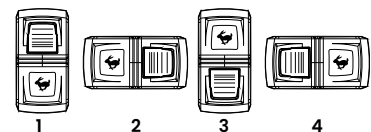

Dimensional Specs

inches [millimeters]

CONTURA II

SHOWN WITH
SQUARE LENS

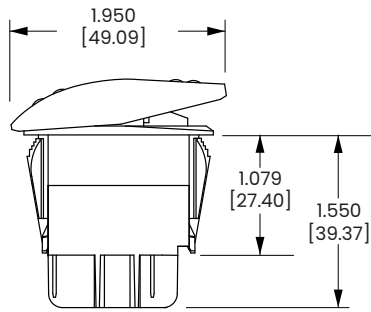
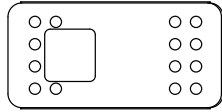

**8 TERMINAL BASE
W/BARRIERS**

CONTURA III

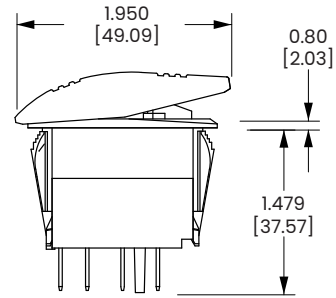
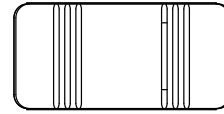

**8 TERMINAL BASE
W/O BARRIERS**

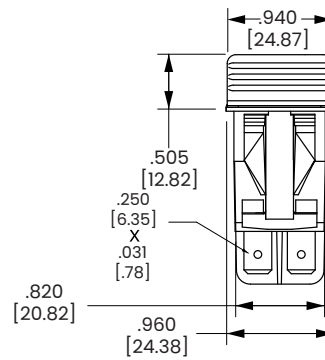
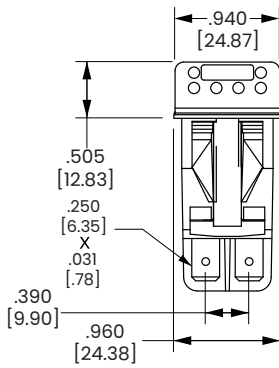

**10 TERMINAL BASE
W/BARRIERS**

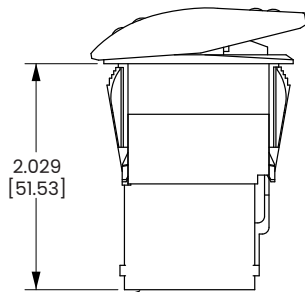

**SWITCH SHOWN WITH
VCH CONNECTOR 8
TERMINAL**

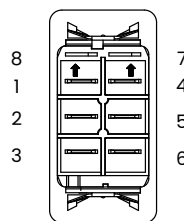

**BOTTOM VIEW
TERMINAL
ARRANGEMENT
8 TERMINAL BASE**

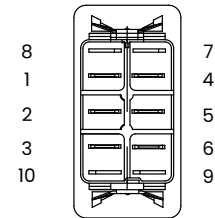

**BOTTOM VIEW
TERMINAL
ARRANGEMENT
10 TERMINAL BASE**

Dimensional Specs

inches [millimeters]

CONTURA IV

SHOWN WITH
BAR LENS

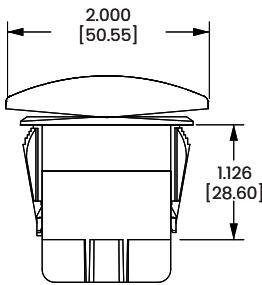
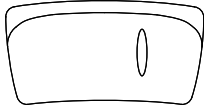

10 TERMINAL BASE
W/BARRIERS

CONTURA V

SHOWN WITH
BAR LENS

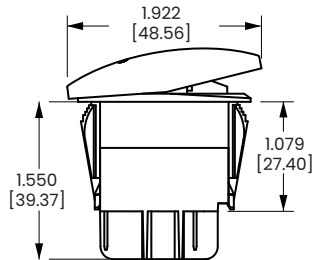
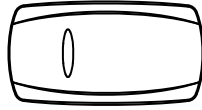

8 TERMINAL BASE
W/BARRIERS

CONTURA V

SHOWN WITH
LOW PROFILE LOCK

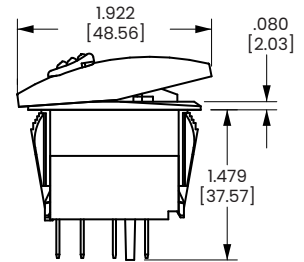
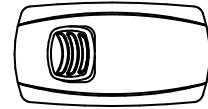

8 TERMINAL BASE
W/O BARRIERS

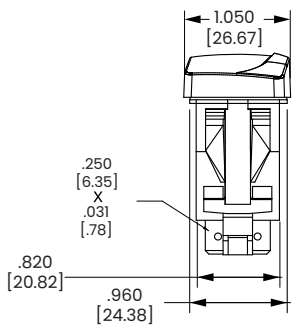

10 TERMINAL BASE
W/O BARRIERS

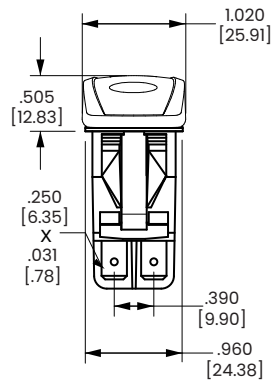

8 TERMINAL BASE
W/BARRIERS

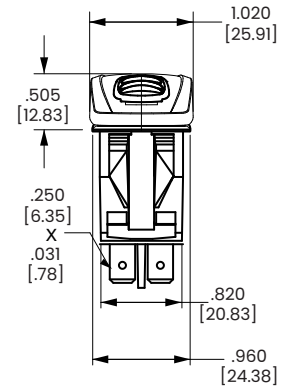

8 TERMINAL BASE
W/O BARRIERS

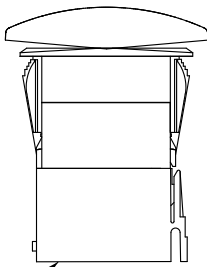

SWITCH SHOWN WITH
VCI CONNECTOR 10
TERMINAL

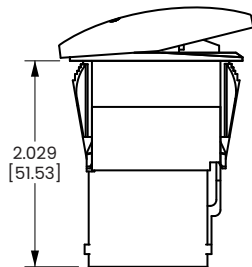

SWITCH SHOWN WITH
VCH CONNECTOR 8
TERMINAL

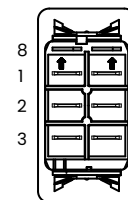

BOTTOM VIEW
TERMINAL
ARRANGEMENT
8 TERMINAL BASE

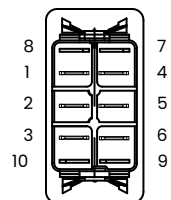

BOTTOM VIEW
TERMINAL
ARRANGEMENT
10 TERMINAL BASE

Dimensional Specs

inches [millimeters]

CONTURA X
SHOWN WITH RAISED BRACKET

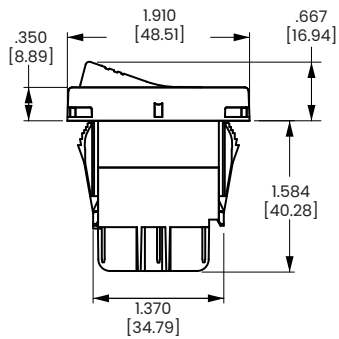
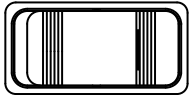

**8 TERMINAL BASE
W/BARRIERS**

CONTURA XI
SHOWN WITH RAISED
BRACKET AND TWO SQUARE
LENSES

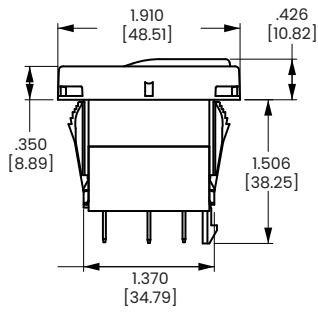
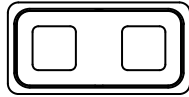

**10 TERMINAL BASE
W/O BARRIERS**

CONTURA XII
SHOWN WITH PADDLE
ACTUATOR

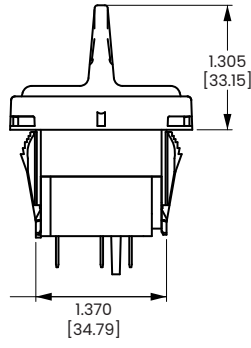
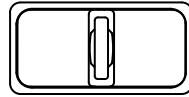

**8 TERMINAL BASE
W/O BARRIERS**

CONTURA XIV
SHOWN WITH LARGE LENS

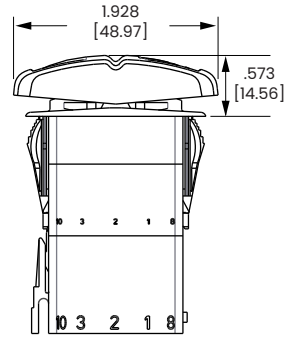
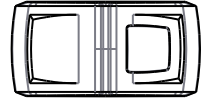

**10 TERMINAL BASE
W/O BARRIERS**

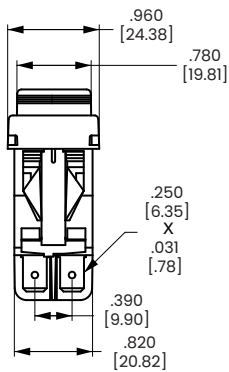

**8 TERMINAL BASE
W/BARRIERS**

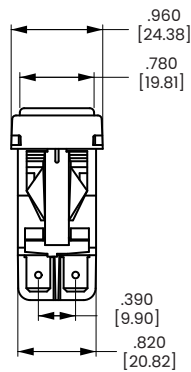

**10 TERMINAL BASE
W/O BARRIERS**

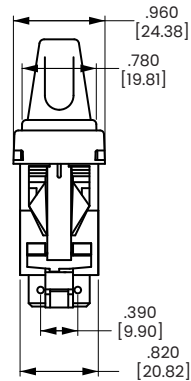

**10 TERMINAL BASE
W/O BARRIERS**

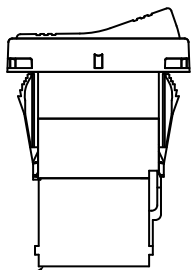
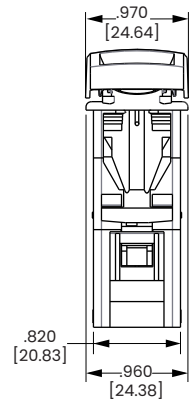

SWITCH SHOWN WITH
VCH CONNECTOR
8 TERMINAL

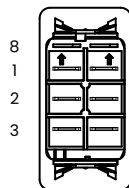

**BOTTOM WITH TERMINAL
ARRANGEMENT
8 TERMINAL BASE**

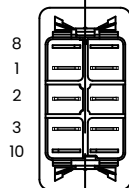

**BOTTOM WITH TERMINAL
ARRANGEMENT
10 TERMINAL BASE**

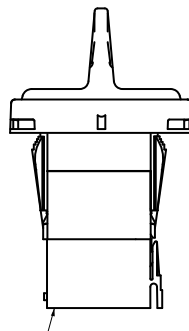

SWITCHES SHOWN WITH
VCI CONNECTOR
10 TERMINAL

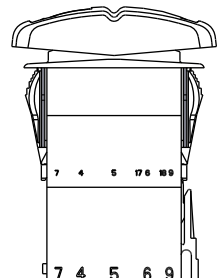

Circuit Diagrams:

| CIRCUIT CODE | CIRCUIT DIAGRAM |
|--------------|-----------------|
| 1 | |
| 2 | |
| 3 | |
| 4 | |
| 5 | |
| 6 | |
| 7 | |
| 8 | |

| CIRCUIT CODE | CIRCUIT DIAGRAM |
|--------------|-----------------|
| A | |
| B | |
| C | |
| D | |
| E | |
| F | |
| G | |
| H | |

| CIRCUIT CODE | CIRCUIT DIAGRAM |
|--------------|-----------------|
| J | |
| K | |
| L | |
| M | |
| R | |
| S | |

| SYMBOL LEGEND | |
|---------------|---|
| SYM. | DEFINITION |
| ○ | DESIGNATES TERMINALS AND CONTACTS |
| —○ | DESIGNATES MAINTAINED CIRCUITS |
| - - | DESIGNATES OTHER POSITION |
| —○ | DESIGNATES MOMENTARY CIRCUITS |
| —○— | DESIGNATES TWO POSITION CONNECTION |
| — | DESIGNATES EXTERNAL JUMPER PROVIDED BY CUSTOMER |

Lamp Circuit Diagrams:

| LAMP CIRCUIT CODE | CIRCUIT DIAGRAM | LAMP CIRCUIT CODE | CIRCUIT DIAGRAM | LAMP CIRCUIT CODE | CIRCUIT DIAGRAM | LAMP CIRCUIT CODE | CIRCUIT DIAGRAM |
|-------------------|-----------------|-------------------|-----------------|-------------------|-----------------|-------------------|-----------------|
| A | | F | | L | | SPECIAL #1 | |
| B | | G | | M | | SPECIAL #3 | |
| C | | H | | N | | SPECIAL #4 | |
| D | | J | | P | | | |
| E | | K | | U | | | |

J-Series Hazard Warning Circuit Diagrams:

| CIRCUIT CODE | CIRCUIT DIAGRAM | CIRCUIT CODE | CIRCUIT DIAGRAM |
|--------------|-----------------|--------------|-----------------|
| J1 | | J5 | |
| J2 | | JA | |
| J3 | | JJ | |
| J4 | | JK | |

NOTE:
J circuits are available for all non-locking V-Series styles. Consult factory for partnumber details.

| SYMBOL LEGEND | |
|---------------|-----------------------------------|
| SYM. | DEFINITION |
| | DESIGNATES TERMINALS AND CONTACTS |
| | DESIGNATES LAMP LOCATION |

Stand-Alone Components

Reduce inventory levels and cost by stocking actuators and base switches separately.

Contura II, III, IV, V, X, XI, XII, XIV Base switches separately: specify V with code selections 2-8 in the ordering schemes.

Contura II, III, IV, V Actuator only: VV with code A or C for selection 9, & with selections 10-14 in the ordering schemes.

Contura II, III, IV, V Actuator only: VV with code A, C, E, G, P or Z for selection 9 & with selections 10-14 in the ordering schemes.

Contura X, XI, XII, XIV actuators with lenses separately: VV with code selections 9-14 in the ordering schemes.

Panel Seal: VPS

Contura X & XI actuators without lenses separately

VVR 6 1 00 1

1 2 3 4 5

1. CONTURA X & XI ACTUATOR SEPARATELY

VVR

2. ACTUATOR STYLE & COLOR

| | | | | |
|------------|-------|------|-------|-----|
| | Black | Gray | White | Red |
| Contura X | 1 | 2 | 3 | 4 |
| Contura XI | 6 | 7 | 8 | 9 |

3. LENS OPENING FOR 1

- 1 One bar lens
- 2 Two bar lenses
- 3 One square lens
- 4 Two square lenses
- 5 square lens on top/
bar lens on bottom
(Contura X only)

4. ACTUATOR LENS OR BODY LEGEND

00 - No Legend this location

| | | | | |
|--------|--------|--------|--------|--|
| 11 ON | 12 OFF | 13 I | 14 O | |
| OFF | ON | O | I | |
| 15 O O | 16 O O | 17 O I | 18 I O | |
| F N | N F | F | | |

For additional legend options & code, visit us at www.carlingtech.com

5. LEGEND ORIENTATION 1

| | | |
|---|---------------|--|
| 0 | No legend | |
| 1 | Orientation 1 | |
| 2 | Orientation 2 | |
| 3 | Orientation 3 | |
| 4 | Orientation 4 | |

Contura X, XI & XII top piece of 2-piece lens separately

VVT 1

1 2

1 TOP OF LENS SEPARATELY

VVT

2 COLOR

1 Clear

Contura X, XI & XII actuator lens assembly:



1 piece lens/bar lens are positioned the same as bottom lens for assembly, minus the top lens. Lenses snap in from bottom.

Notes:

- If actuator lens opening for 2 bar or 2 square lenses, legend orientation 0,1, or 2 must be chosen.
- Center of actuator marking not available for Contura XII.
- Legend is not available for bar style lens.
- Not recommended with neon lamps.
- Must also order top piece of 2 piece square lens separately.

Contura XII actuators without lenses separately

VVP J 1 Z 21 1 00

1 2 3 4 5 6 7

1 CONTURA XII ACTUATOR SEPARATELY

VVP

2. ACTUATOR STYLE & COLOR

J Black K Gray N White M Red

3,4 LENS OPENING FOR 1

Z No lens 1 Bar lens 2 Square lens

5, 7 LENS OR BODY LEGEND 2

| | | | | | |
|----------------|--------|--------|------|------|--|
| 00 - No Legend | 21 OFF | 22 ON | 23 O | 24 I | |
| | 25 O F | 26 O N | 27 O | 28 I | |

For additional legend options & codes, visit us at www.carlingtech.com

6 LEGEND ORIENTATION 3

| | | |
|---|---------------|--|
| 0 | No legend | |
| 1 | Orientation 1 | |
| 2 | Orientation 2 | |

Contura X, XI & XII actuator lens assembly separately

VVL 2 1 00 0

1 2 3 4 5

1 CONTURA X, XI & XII LENS SEPARATELY

VVL

2 LENS STYLE 3

- 1 Bar lens
- 2 One Piece Square lens
- 3 Bottom of Two-Piece Square lens⁵

3 TRANSLUCENT LENS COLOR

1 Clear 2 White 3 Amber 4 Green⁴ 5 Red 6 Blue⁴

4 LENS OR BODY LEGEND 2

| | | | | | |
|----------------|--------|--------|------|------|--|
| 00 - No Legend | 21 OFF | 22 ON | 23 O | 24 I | |
| | 25 O F | 26 O N | 27 O | 28 I | |

For additional legend options & codes, visit us at www.carlingtech.com.

5 LEGEND ORIENTATION 3

| | | |
|---|---------------|--|
| 0 | No legend | |
| 1 | Orientation 1 | |
| 2 | Orientation 2 | |
| 3 | Orientation 3 | |
| 4 | Orientation 4 | |

Accessories

Easily integrate Contura products into your system, with Contura Accessories

Contura Connectors



| Q.C. SELECTION GUIDE | | | | | |
|-------------------------------|-------------|------------------|------------|-----------------------|-------------|
| COMPANY SERIES | PART NO | | WIRE RANGE | | ORIENTATION |
| | PLAIN BRASS | TIN PLATED BRASS | AWG | MM ² (REF) | |
| PACKARD 58 SERIES | 02965580 | | 12 | 3.0 | B |
| | 02965471 | 12010601 | (2)16-14 | (2)1.0-2.0 | |
| | 02965470 | | 16-14 | 1.0-2.0 | |
| | 02965469 | 06288318 | 20-18 | .5-.8 | |
| PACKARD METRI-PACK 630 SERIES | | 12084590 | 105.0 | | A |
| | | 12052224 | 123.0 | | |
| | | 12015870 | 16-14 | 1.0-2.0 | |
| | | 12020035 | (2)22-18 | (2).5-.8 | |
| | | 12015869 | 20-18 | .5-.8 | |
| | | 12052222 | 20-22 | .35-.5 | |
| AMP 250 SERIES FASTIN-FASTON | 60253-1 | 60253-2 | 16-12 | 1.3-3 | B |
| | 42100-1 | 42100-2 | 18-14 | .8-2 | |
| | 60295-1 | 60295-2 | 22-18 | .3-.9 | |

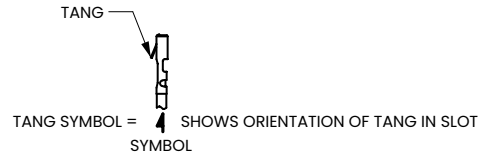

NOTE: Consult Delphi Packard and/or Amp on actual part numbers and availability. AMP is a registered trademark of AMP Inc. Harrisburg, PA. Delphi Packard is a registered trademark of Delphi-Packard Electrical Systems Warr

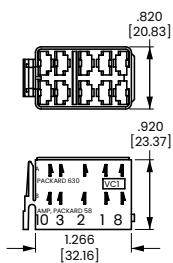

VC1 CONNECTOR HOUSING

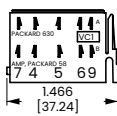

MARKING DETAIL REAR VIEW

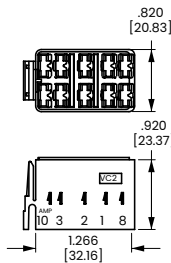

VC2 CONNECTOR HOUSING (For AMP terminals only)

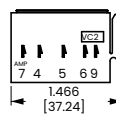

MARKING DETAIL REAR VIEW

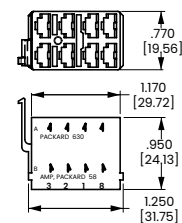

VCH CONNECTOR HOUSING

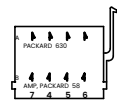

MARKING DETAIL REAR VIEW

Contura X Boot (P/N VB1-01)

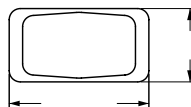

Contura II, III, IV and V Actuator Removal Tool (P/N VRT)

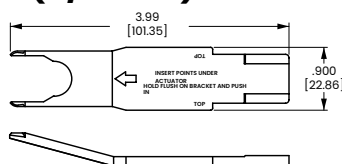

Additional V-Series Ratings

- 1 .4VA @ 28VDC Resistive
- 4 10A 250VAC 1/2 HP, 15A 125 VAC 1/2 HP, No Agency Listings
- 5¹ 10A 250VAC 1/2 HP, 15A 125 VAC 1/2 HP, UL Recognized, CSA Certified
- B 15A 24V
- C 20A 18V
- D 20A 12V
- E 20A 14V, 10A 14VT (circuits 1, 4, A, & D only)
- F 10A 14V, 6A, 14VT (circuit G only)
- G 20A 6V
- H 20A 3V
- L² 15A 125 VAC, 10A 250VAC, 1/2 HP 125-250 VAC; 6A 125 VAC L

NOTES

Consult factory to determine availability for individual circuits and their HP rating.

1. Not available with Contura 7 or 14 rocker styles.
2. Rating L available with circuits 1, 4, A & D only.

Accessories

Contura Mounting Panels Dimensional Specifications: in. [mm]

MOUNTING PANEL
For additional units, add 1.03 [26.2] per unit. For more than 2 V-Series Switches, add middle section. Available in panel Thicknesses listed below. Consult factory.

| MOUNTING PANEL THICKNESS | |
|--------------------------|--------|
| .862 | .887 |
| [1.57] | [4.76] |
| .983 | .290 |
| [2.36] | [6.35] |
| .325 | .375 |
| [3.17] | [9.52] |

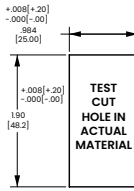

VMS MOUNTING PANEL HOLE

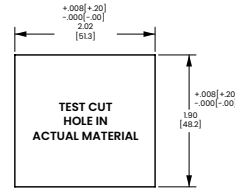

MOUNTING PANEL OPENING (2) UNITS

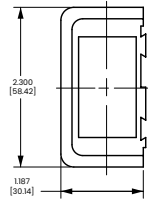

VME MOUNTING PANEL END

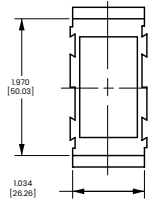

VMM MOUNTING PANEL MIDDLE

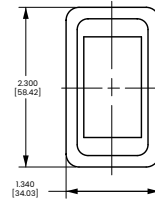

VMS MOUNTING PANEL

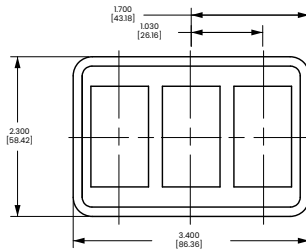

VM3 MOUNTING PANEL

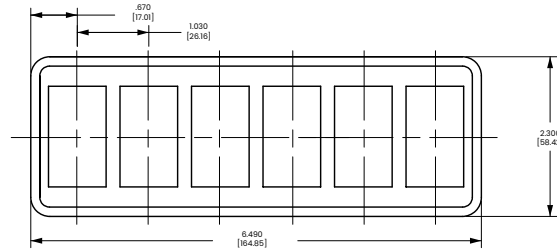

VM6 MOUNTING PANEL



Contura Hole Plug Dimensional Specifications: in. [mm]

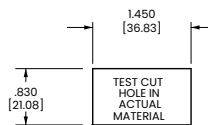

VHP CONTURA II,III HOLE PLUG

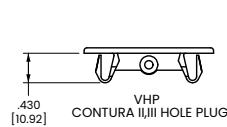

VHP CONTURA IV HOLE PLUG

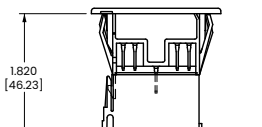

VHI STANDARD HOLE PLUG (No wing serrations) (With VC1 connector attached)

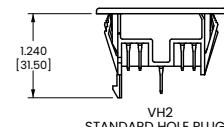

VH2 STANDARD HOLE PLUG (With wing serrations)

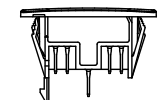
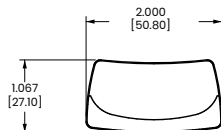

VH3 CONTURA IV HOLE PLUG (No wing serrations)

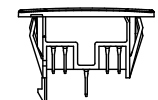

VH4 CONTURA IV HOLE PLUG (With wing serrations)



DETAIL VIEW VH1, VH3 & VH5 HOLE PLUGS (No wing serrations for ease of removal)

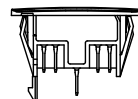
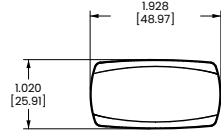

VH5 CONTURA V HOLE PLUG (No wing serrations)

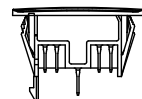

VH6 CONTURA V HOLE PLUG (With wing serrations)



DETAIL VIEW VH2, VH4 & VH6 HOLE PLUGS (With wing serrations)



Standard Legend Codes

| | | | | | | | | | | | | |
|-------|--------|-------|--------|--------|-----|-------|----------|------|----------|-----------------|-----------|------|
| | | | | | | | | | | | | |
| YK | UA | UB | US | UV | UW | UX | UY | MP | MR | PX | MS | MT |
| | | | | | | | | | | | | |
| VU | MW | NZ | NX | NY | YM | VW | PS | PW | PZ | WG | WM | RN |
| | | | | | | | | | | | | |
| RP | YG | TX | VD | VE | VF | VG | SH | SM | SN | SP | SR | SY |
| | | | | | | | | | | | | |
| DIM | BRIGHT | UH | UJ | PD | PE | PF | VC | VJ | UF | UG | MU | TN |
| | | | | | | | | | | | | |
| WY | WZ | WIPER | VZ | YE | NN | RW | PU | WA | YN | UE | NM | RJ |
| | | | | | | | | | | | | |
| NS | PB | SE | VR | SL | VA | UC | VN | PK | VY | HORN | RH | NU |
| | | | | | | | | | | | | |
| NR | YD | TL | VR | SL | VA | UC | VN | PK | VY | UZ | RH | NU |
| | | | | | | | | | | | | |
| NV | RB | RC | RK | RL | MZ | RG | UP | DOWN | UD | UR | WD | TY |
| | | | | | | | | | | | | |
| PA | UK | WR | UU | UT | YR | PM | VV | WB | TB | TC | TD | TE |
| | | | | | | | | | | | | |
| MY | PV | TA | TZ | WC | PT | PN | PH | RA | TU | TT | YL | SK |
| | | | | | | | | | | | | |
| VS | UL | UM | WK | TS | VT | WL | VP | YJ | PJ | RY | UP | NW |
| | | | | | | | | | | | | |
| NP | RE | RF | PP | PR | TV | PC | YT | YU | PL | WJ | MV | RR |
| | | | | | | | | | | | | |
| TK | RT | SEAT | VX | WF | WH | PG | SJ | YA | YB | RM | TM | RD |
| | | | | | | | | | | | | |
| RS | UN | TP | TR | NT | MX | YC | TW | TJ | YF | TH | TF | TG |
| | | | | | | | | | | | | |
| YS | YH | AUX | ON OFF | OFF ON | I O | O I | OFF ON | ON | OFF | I | O | II |
| | | | | | | | | | | | | |
| RAISE | LOWER | HIGH | LOW | FWD | REV | DEPTH | TRIM TAB | ACC | NAV ANCH | WIND LASS UP/DN | LIVE WELL | REAR |
| | | | | | | | | | | | | |
| ST | SU | WU | WV | SV | SW | VB | VH | VK | VL | VM | WE | SF |
| | | | | | | | | | | | | |
| PARK | AUTO | RU | RV | RX | | | | | | | | |
| | | | | | | | | | | | | |
| SG | SS | | | | | | | | | | | |