

POWR-SPEED® Fuse

PSR Series High-Speed Square Body

Semiconductor Fuses • Flush End • 40 A–2250 A



Description

Littelfuse PSR series high-speed square body fuses are specially designed for protection of power semiconductor devices such as diodes, triacs, IGBTs, SCRs, MOSFETs, and other solid state devices that are typically designed into power conversion and power conditioning equipment. Variable frequency drives, inverters, UPS, rectifiers, and soft-starters are examples of typical equipment designed with sensitive power semiconductor devices that cannot withstand any line surge or overcurrent conditions and require high-speed protection.

Littelfuse POWR-SPEED PSR series products offer optimized circuit protection at the extremely fast speed required to protect modern day power conversion devices. Such products are commonly found in numerous applications including pulp and paper industries, cranes and heavy-lifting equipment, processing industries, wastewater treatment plants, and various large factories and MRO facilities.

Features/Benefits

- Best in class dc performance
- Extremely current limiting
- Superior cycling capability
- Global certification cURus, CCC*
- Direct bus-bar mount design
- Visual and optional microswitch fuse blown indication
- Low watt-loss design
- Compliance with US and Canadian requirements
- Fast-acting Class aR performance

Applications

- Power conversion devices (UPS, inverter, rectifiers, drives)
- Dc systems (dc common bus, dc injection braking)
- Battery protection application (energy storage systems)
- Electric vehicle charging stations
- Heaters and power supplies

* Refer to CCC section of Electrical Characteristics table

Specifications

| | |
|------------------------------|---|
| Voltage Range | Ac: 450 V–1300 V Dc: 450 V–1000 V |
| Amperage Range | 40 A–2250 A |
| Interrupting Range | Ac: 100 kA–200 kA Dc: 150 kA |
| Time Constant | 10 ms at IR |
| Microswitch | Yes |
| Mounting | Flush-end style |
| Material | Body: ceramic Contacts: plated brass |
| Approvals | cURus Recognized (File: E71611) CCC (Ac voltage) * |
| Applicable Standards | UL248-13, IEC 60269-4 (Class aR) |
| Environmental | RoHS Compliant, REACH |
| Operating Temperature | -55 °C to +125 °C |
| Storage Temperature | Up to +35 °C with relative humidity <65 % |
| Country of Origin | Mexico |

For additional product information, contact Littelfuse Technical Support at 1-800-TEC-FUSE or techline@littelfuse.com

Ordering Part Number

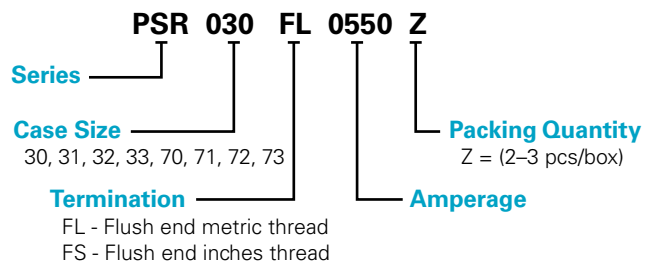

Catalog Number

| SERIES | CASE SIZE | TERMINATION | AMPERAGE | CATALOG NUMBER | ORDERING PART NUMBER |
|--------|-----------|-------------|----------|----------------|----------------------|
| PSR | 030 | FL | 0550 | PSR030FL0550 | PSR030FL0550Z |

Recommended Accessories

Microswitch: MS3H1000C (case size 30 to 33)
MS7H1500C (case size 70 to 73)

Web Resources

Download technical documents: Littelfuse.com/PSR
Note: high-speed fuses are designed for fixed installations. They are not intended for use in moving vehicle applications.

POWR-SPEED® Fuse

PSR Series High-Speed Square Body

Electrical Characteristics

| CASE SIZE | CATALOG NUMBER | | AMPERE RATING (A) | VOLTAGE RATING (V) | | | INTERRUPTING RATING | | MELTING (PRE-ARC) I ² T (A ² s) | TOTAL CLEARING I ² T (A ² s) AT RATED VOLTAGE | | WATT LOSS AT 100 % RATED CURRENT (W) | AGENCY CERTIFICATION | |
|--------------|-------------------------|-------------------------|-------------------|--------------------|-------|--------|---------------------|---------|---|---|---------|--------------------------------------|----------------------|------|
| | FLUSH END METRIC THREAD | FLUSH END INCHES THREAD | | AC | | DC | AC | DC | | AC | DC | | cURus | CCC* |
| | | | | IEC | UL | | | | | | | | | |
| 30 | PSR030FL0040 | PSR030FS0040 | 40 | 690 | 700 | 600 | 200 kA | 150 kA | 76 | 280 | 260 | 12 | • | • |
| | PSR030FL0050 | PSR030FS0050 | 50 | 690 | 700 | 600 | 200 kA | 150 kA | 110 | 598 | 384 | 15 | • | • |
| | PSR030FL0063 | PSR030FS0063 | 63 | 690 | 700 | 600 | 200 kA | 150 kA | 176 | 1023 | 640 | 20 | • | • |
| | PSR030FL0080 | PSR030FS0080 | 80 | 690 | 700 | 600 | 200 kA | 150 kA | 304 | 1728 | 1252 | 24 | • | • |
| | PSR030FL0100 | PSR030FS0100 | 100 | 690 | 700 | 600 | 200 kA | 150 kA | 437 | 2835 | 1575 | 27 | • | • |
| | PSR030FL0125 | PSR030FS0125 | 125 | 690 | 700 | 600 | 200 kA | 150 kA | 707 | 4684 | 2783 | 36 | • | • |
| | PSR030FL0160 | PSR030FS0160 | 160 | 690 | 700 | 600 | 200 kA | 150 kA | 1359 | 9114 | 5507 | 39 | • | • |
| | PSR030FL0200 | PSR030FS0200 | 200 | 690 | 700 | 600 | 200 kA | 150 kA | 3012 | 15169 | 14700 | 39 | • | • |
| | PSR030FL0250 | PSR030FS0250 | 250 | 690 | 700 | 600 | 200 kA | 150 kA | 4668 | 29952 | 20833 | 50 | • | • |
| | PSR030FL0315 | PSR030FS0315 | 315 | 690 | 700 | 600 | 200 kA | 150 kA | 7131 | 61830 | 31600 | 61 | • | • |
| | PSR030FL0350 | PSR030FS0350 | 350 | 690 | 700 | 600 | 200 kA | 150 kA | 12007 | 85320 | 49273 | 62 | • | • |
| | PSR030FL0400 | PSR030FS0400 | 400 | 690 | 700 | 600 | 200 kA | 150 kA | 16209 | 114750 | 63367 | 75 | • | • |
| | PSR030FL0450 | PSR030FS0450 | 450 | 690 | 700 | 600 | 200 kA | 150 kA | 23133 | 160110 | 93533 | 75 | • | • |
| | PSR030FL0500 | PSR030FS0500 | 500 | 690 | 700 | 600 | 200 kA | 150 kA | 31429 | 225180 | 137333 | 80 | • | • |
| PSR030FL0550 | PSR030FS0550 | 550 | 690 | 700 | 600 | 200 kA | 150 kA | 44323 | 268920 | 145400 | 78 | • | • | |
| PSR030FL0630 | PSR030FS0630 | 630 | 690 | 700 | 550 | 200 kA | 150 kA | 57404 | 480010 | 267800 | 90 | • | • | |
| 31 | PSR031FL0200 | PSR031FS0200 | 200 | 690 | 700 | 600 | 200 kA | 150 kA | 1965 | 17334 | 16188 | 49 | • | • |
| | PSR031FL0250 | PSR031FS0250 | 250 | 690 | 700 | 600 | 200 kA | 150 kA | 3789 | 35343 | 21080 | 52 | • | • |
| | PSR031FL0315 | PSR031FS0315 | 315 | 690 | 700 | 600 | 200 kA | 150 kA | 6862 | 59130 | 30694 | 61 | • | • |
| | PSR031FL0350 | PSR031FS0350 | 350 | 690 | 700 | 600 | 200 kA | 150 kA | 9523 | 76140 | 40996 | 63 | • | • |
| | PSR031FL0400 | PSR031FS0400 | 400 | 690 | 700 | 600 | 200 kA | 150 kA | 14770 | 124335 | 64359 | 64 | • | • |
| | PSR031FL0450 | PSR031FS0450 | 450 | 690 | 700 | 600 | 200 kA | 150 kA | 22457 | 178200 | 97444 | 69 | • | • |
| | PSR031FL0500 | PSR031FS0500 | 500 | 690 | 700 | 600 | 200 kA | 150 kA | 29751 | 251505 | 125935 | 81 | • | • |
| | PSR031FL0550 | PSR031FS0550 | 550 | 690 | 700 | 600 | 200 kA | 150 kA | 42056 | 289170 | 171845 | 77 | • | • |
| | PSR031FL0630 | PSR031FS0630 | 630 | 690 | 700 | 600 | 200 kA | 150 kA | 45403 | 415500 | 175500 | 93 | • | • |
| | PSR031FL0700 | PSR031FS0700 | 700 | 690 | 700 | 600 | 200 kA | 150 kA | 98187 | 601425 | 337260 | 92 | • | • |
| PSR031FL0800 | PSR031FS0800 | 800 | 690 | 700 | 600 | 200 kA | 150 kA | 137208 | 848880 | 502800 | 106 | • | • | |
| PSR031FL0900 | PSR031FS0900 | 900 | 550 | 600 | 550 | 200 kA | 150 kA | 155163 | 945100 | 631820 | 118 | • | • | |
| 32 | PSR032FL0400 | PSR032FS0400 | 400 | 690 | 700 | 600 | 200 kA | 150 kA | 11104 | 79650 | 44533 | 82 | • | • |
| | PSR032FL0450 | PSR032FS0450 | 450 | 690 | 700 | 600 | 200 kA | 150 kA | 15535 | 116100 | 65463 | 88 | • | • |
| | PSR032FL0500 | PSR032FS0500 | 500 | 690 | 700 | 600 | 200 kA | 150 kA | 21573 | 161460 | 88277 | 94 | • | • |
| | PSR032FL0550 | PSR032FS0550 | 550 | 690 | 700 | 600 | 200 kA | 150 kA | 26327 | 177660 | 107960 | 104 | • | • |
| | PSR032FL0630 | PSR032FS0630 | 630 | 690 | 700 | 600 | 200 kA | 150 kA | 34790 | 234900 | 156963 | 110 | • | • |
| | PSR032FL0700 | PSR032FS0700 | 700 | 690 | 700 | 600 | 200 kA | 150 kA | 51191 | 291870 | 209287 | 117 | • | • |
| | PSR032FL0800 | PSR032FS0800 | 800 | 690 | 700 | 600 | 200 kA | 150 kA | 60125 | 472770 | 249000 | 145 | • | • |
| | PSR032FL0900 | PSR032FS0900 | 900 | 690 | 700 | 600 | 200 kA | 150 kA | 107785 | 764100 | 404000 | 145 | • | • |
| | PSR032FL1000 | PSR032FS1000 | 1000 | 690 | 700 | 600 | 200 kA | 150 kA | 190102 | 933120 | 672333 | 146 | • | • |
| | PSR032FL1100 | PSR032FS1100 | 1100 | 690 | 700 | 600 | 200 kA | 150 kA | 225379 | 1247400 | 744000 | 149 | • | • |
| | PSR032FL1250 | PSR032FS1250 | 1250 | 550 | 500** | 450** | 200 kA | 150 kA | 336661 | 1114994 | 1197000 | 149 | • | • |
| | PSR032FL1400 | PSR032FS1400 | 1400 | 450 | 500 | 450 | 200 kA | 150 kA | 551749 | 1611639 | 1865400 | 154 | • | • |
| PSR032FL1500 | PSR032FS1500 | 1500 | 450 | 500 | 450 | 200 kA | 150 kA | 673360 | 2045907 | 1735500 | 171 | • | • | |
| 33 | PSR033FL0450 | PSR033FS0450 | 450 | 690 | 700 | 600 | 200 kA | 150 kA | 13600 | 106380 | 58947 | 99 | • | • |
| | PSR033FL0500 | PSR033FS0500 | 500 | 690 | 700 | 600 | 200 kA | 150 kA | 16434 | 140400 | 77846 | 107 | • | • |
| | PSR033FL0550 | PSR033FS0550 | 550 | 690 | 700 | 600 | 200 kA | 150 kA | 23314 | 187650 | 100461 | 108 | • | • |
| | PSR033FL0630 | PSR033FS0630 | 630 | 690 | 700 | 600 | 200 kA | 150 kA | 38727 | 285930 | 142437 | 113 | • | • |
| | PSR033FL0700 | PSR033FS0700 | 700 | 690 | 700 | 600 | 200 kA | 150 kA | 56763 | 392580 | 209863 | 113 | • | • |
| | PSR033FL0800 | PSR033FS0800 | 800 | 690 | 700 | 600 | 200 kA | 150 kA | 84691 | 575505 | 348500 | 120 | • | • |
| | PSR033FL0900 | PSR033FS0900 | 900 | 690 | 700 | 600 | 200 kA | 150 kA | 122619 | 740340 | 451177 | 122 | • | • |
| | PSR033FL1000 | PSR033FS1000 | 1000 | 690 | 700 | 600 | 200 kA | 150 kA | 222350 | 1170450 | 787750 | 124 | • | • |
| | PSR033FL1100 | PSR033FS1100 | 1100 | 690 | 700 | 600 | 200 kA | 150 kA | 310824 | 1568700 | 821400 | 127 | • | • |
| | PSR033FL1250 | PSR033FS1250 | 1250 | 690 | 700 | 600 | 200 kA | 150 kA | 476902 | 2403000 | 1674333 | 131 | • | • |
| | PSR033FL1400 | PSR033FS1400 | 1400 | 690 | 700 | 500 | 200 kA | 150 kA | 583552 | 2920050 | 1979750 | 144 | • | • |
| | PSR033FL1500 | PSR033FS1500 | 1500 | 600 | 650 | 500 | 200 kA | 150 kA | 674538 | 2433200 | 1996733 | 163 | • | • |
| | PSR033FL1600 | PSR033FS1600 | 1600 | 600 | 650 | 500 | 200 kA | 150 kA | 779948 | 2942800 | 2301633 | 182 | • | • |
| | PSR033FL1800 | PSR033FS1800 | 1800 | 600 | 650 | 500 | 200 kA | 150 kA | 952196 | 3785040 | 2724180 | 224 | • | • |
| | PSR033FL2000 | PSR033FS2000 | 2000 | 550 | 600 | 500 | 200 kA | 150 kA | 1234315 | 4131600 | 3755180 | 222 | • | • |
| PSR033FL2250 | PSR033FS2250 | 2250 | 500 | 550 | 450 | 200 kA | 150 kA | 1236000 | 4459651 | 3859500 | 299 | • | • | |

* CCC Certification only on Flush End Metric Thread Version

** PSR032 1250 A: 600 V AC/550 V DC

POWR-SPEED® Fuse

PSR Series High-Speed Square Body

Electrical Characteristics (Continued)

| CASE SIZE | CATALOG NUMBER | | AMPERE RATING (A) | VOLTAGE RATING (V) | | | INTERRUPTING RATING | | MELTING (PRE-ARC) I ² T (A ² s) | TOTAL CLEARING I ² T (A ² s) AT RATED VOLTAGE | | WATT LOSS AT 100 % RATED CURRENT (W) | AGENCY CERTIFICATION | |
|--------------|-------------------------|-------------------------|-------------------|--------------------|--------|---------|---------------------|--------|---|---|---------|--------------------------------------|----------------------|------|
| | FLUSH END METRIC THREAD | FLUSH END INCHES THREAD | | AC | | DC | AC | DC | | AC | DC | | cURus | CCC* |
| | | | | IEC | UL | | | | | | | | | |
| 70 | PSR070FL0050 | PSR070FS0050 | 50 | 1250 | 1300 | 1000 | 100 kA | 150 kA | 177 | 2050 | 400 | 21 | • | • |
| | PSR070FL0063 | PSR070FS0063 | 63 | 1250 | 1300 | 1000 | 100 kA | 150 kA | 273 | 3399 | 900 | 23 | • | • |
| | PSR070FL0080 | PSR070FS0080 | 80 | 1250 | 1300 | 1000 | 100 kA | 150 kA | 583 | 6732 | 2200 | 24 | • | • |
| | PSR070FL0100 | PSR070FS0100 | 100 | 1250 | 1300 | 1000 | 100 kA | 150 kA | 974 | 10996 | 3750 | 29 | • | • |
| | PSR070FL0125 | PSR070FS0125 | 125 | 1250 | 1300 | 1000 | 100 kA | 150 kA | 1352 | 13011 | 5150 | 43 | • | • |
| | PSR070FL0160 | PSR070FS0160 | 160 | 1250 | 1300 | 1000 | 100 kA | 150 kA | 2377 | 25662 | 8950 | 51 | • | • |
| | PSR070FL0200 | PSR070FS0200 | 200 | 1250 | 1300 | 1000 | 100 kA | 150 kA | 4177 | 39087 | 17267 | 61 | • | • |
| | PSR070FL0250 | PSR070FS0250 | 250 | 1250 | 1300 | 1000 | 100 kA | 150 kA | 8629 | 89790 | 36750 | 71 | • | • |
| | PSR070FL0280 | PSR070FS0280 | 280 | 1250 | 1300 | 1000 | 100 kA | 150 kA | 11844 | 113201 | 46750 | 71 | • | • |
| | PSR070FL0315 | PSR070FS0315 | 315 | 1250 | 1300 | 1000 | 100 kA | 150 kA | 18162 | 142051 | 66833 | 69 | • | • |
| | PSR070FL0350 | PSR070FS0350 | 350 | 1250 | 1200** | 1000 | 100 kA | 150 kA | 22963 | 215230 | 95410 | 73 | • | • |
| PSR070FL0400 | PSR070FS0400 | 400 | 1100 | 1200 | 900 | 100 kA | 150 kA | 37103 | 283480 | 154320 | 71 | • | • | |
| 71 | PSR071FL0160 | PSR071FS0160 | 160 | 1250 | 1300 | 1000 | 100 kA | 150 kA | 2756 | 24600 | 8800 | 42 | • | • |
| | PSR071FL0200 | PSR071FS0200 | 200 | 1250 | 1300 | 1000 | 100 kA | 150 kA | 4918 | 50307 | 19050 | 52 | • | • |
| | PSR071FL0250 | PSR071FS0250 | 250 | 1250 | 1300 | 1000 | 100 kA | 150 kA | 10592 | 104427 | 43100 | 54 | • | • |
| | PSR071FL0280 | PSR071FS0280 | 280 | 1250 | 1300 | 1000 | 100 kA | 150 kA | 13763 | 131897 | 54150 | 58 | • | • |
| | PSR071FL0315 | PSR071FS0315 | 315 | 1250 | 1300 | 1000 | 100 kA | 150 kA | 20882 | 200244 | 67450 | 60 | • | • |
| | PSR071FL0350 | PSR071FS0350 | 350 | 1250 | 1300 | 1000 | 100 kA | 150 kA | 23301 | 225500 | 102500 | 71 | • | • |
| | PSR071FL0400 | PSR071FS0400 | 400 | 1250 | 1300 | 1000 | 100 kA | 150 kA | 43211 | 374986 | 185000 | 69 | • | • |
| | PSR071FL0450 | PSR071FS0450 | 450 | 1250 | 1300 | 1000 | 100 kA | 150 kA | 55915 | 452394 | 241333 | 88 | • | • |
| | PSR071FL0500 | PSR071FS0500 | 500 | 1100 | 1200 | 900 | 100 kA | 150 kA | 75315 | 468845 | 253960 | 82 | • | • |
| | PSR071FL0550 | PSR071FS0550 | 550 | 1100 | 1200 | 900 | 100 kA | 150 kA | 87328 | 693507 | 332600 | 90 | • | • |
| PSR071FL0630 | PSR071FS0630 | 630 | 1000 | 1100 | 900 | 100 kA | 150 kA | 131240 | 790862 | 426550 | 100 | • | • | |
| 72 | PSR072FL0250 | PSR072FS0250 | 250 | 1250 | 1300 | 1000 | 100 kA | 150 kA | 7737 | 72789 | 28567 | 63 | • | • |
| | PSR072FL0280 | PSR072FS0280 | 280 | 1250 | 1300 | 1000 | 100 kA | 150 kA | 10915 | 124538 | 46897 | 62 | • | • |
| | PSR072FL0315 | PSR072FS0315 | 315 | 1250 | 1300 | 1000 | 100 kA | 150 kA | 16187 | 145140 | 58867 | 67 | • | • |
| | PSR072FL0350 | PSR072FS0350 | 350 | 1250 | 1300 | 1000 | 100 kA | 150 kA | 18727 | 160447 | 69633 | 80 | • | • |
| | PSR072FL0400 | PSR072FS0400 | 400 | 1250 | 1300 | 1000 | 100 kA | 150 kA | 27112 | 243540 | 108000 | 89 | • | • |
| | PSR072FL0450 | PSR072FS0450 | 450 | 1250 | 1300 | 1000 | 100 kA | 150 kA | 35927 | 406413 | 159133 | 107 | • | • |
| | PSR072FL0500 | PSR072FS0500 | 500 | 1250 | 1300 | 1000 | 100 kA | 150 kA | 50398 | 425375 | 216333 | 115 | • | • |
| | PSR072FL0550 | PSR072FS0550 | 550 | 1250 | 1300 | 1000 | 100 kA | 150 kA | 73858 | 539833 | 271333 | 115 | • | • |
| | PSR072FL0630 | PSR072FS0630 | 630 | 1250 | 1300 | 1000 | 100 kA | 150 kA | 126126 | 942180 | 436000 | 119 | • | • |
| | PSR072FL0700 | PSR072FS0700 | 700 | 1100 | 1200 | 900 | 100 kA | 150 kA | 228761 | 1123694 | 715180 | 115 | • | • |
| | PSR072FL0800 | PSR072FS0800 | 800 | 1100 | 1200 | 900 | 100 kA | 150 kA | 230695 | 1432388 | 911650 | 113 | • | • |
| | PSR072FL0900 | PSR072FS0900 | 900 | 1000 | 900** | 900*** | 100 kA | 150 kA | 376641 | 1309993 | 1030400 | 125 | • | • |
| PSR072FL1000 | PSR072FS1000 | 1000 | 850 | 900 | 800*** | 100 kA | 150 kA | 455955 | 1772548 | 1361500 | 136 | • | • | |
| 73 | PSR073FL0315 | PSR073FS0315 | 315 | 1250 | 1300 | 1000 | 100 kA | 150 kA | 10245 | 106600 | 38650 | 88 | • | • |
| | PSR073FL0350 | PSR073FS0350 | 350 | 1250 | 1300 | 1000 | 100 kA | 150 kA | 13586 | 159627 | 57467 | 96 | • | • |
| | PSR073FL0400 | PSR073FS0400 | 400 | 1250 | 1300 | 1000 | 100 kA | 150 kA | 19797 | 211273 | 86800 | 124 | • | • |
| | PSR073FL0450 | PSR073FS0450 | 450 | 1250 | 1300 | 1000 | 100 kA | 150 kA | 29834 | 279073 | 114333 | 122 | • | • |
| | PSR073FL0500 | PSR073FS0500 | 500 | 1250 | 1300 | 1000 | 100 kA | 150 kA | 42751 | 416437 | 184500 | 121 | • | • |
| | PSR073FL0550 | PSR073FS0550 | 550 | 1250 | 1300 | 1000 | 100 kA | 150 kA | 55513 | 491713 | 224500 | 130 | • | • |
| | PSR073FL0630 | PSR073FS0630 | 630 | 1250 | 1300 | 1000 | 100 kA | 150 kA | 94649 | 804338 | 377500 | 136 | • | • |
| | PSR073FL0700 | PSR073FS0700 | 700 | 1250 | 1300 | 1000 | 100 kA | 150 kA | 158097 | 1170960 | 575667 | 135 | • | • |
| | PSR073FL0800 | PSR073FS0800 | 800 | 1250 | 1300 | 1000*** | 100 kA | 150 kA | 234943 | 1769880 | 733460 | 123 | • | • |
| | PSR073FL0900 | PSR073FS0900 | 900 | 950 | 1050 | 800*** | 100 kA | 150 kA | 317743 | 2280547 | 901779 | 140 | • | • |
| | PSR073FL1000 | PSR073FS1000 | 1000 | 950 | 1050 | 800*** | 100 kA | 150 kA | 476221 | 3910801 | 1546418 | 128 | • | • |
| | PSR073FL1100 | PSR073FS1100 | 1100 | 950 | 1050 | 800*** | 100 kA | 150 kA | 570870 | 2736600 | 1699000 | 166 | • | • |
| | PSR073FL1250 | PSR073FS1250 | 1250 | 900 | 1000 | - | 100 kA | - | 993924 | 3091160 | - | 182 | • | • |
| | PSR073FL1400 | PSR073FS1400 | 1400 | 900 | 1000 | - | 100 kA | - | 1168091 | 3627820 | - | 229 | • | • |

* CCC Certification only on Flush End Metric Thread Version

** PSR070 350 A: 1300 V Ac

PSR072 900 A: 1100 V Ac

*** No UL certification for Dc voltage

POWR-SPEED® Fuse

PSR Series High-Speed Square Body

Ordering Information

| CASE SIZE | FLUSH END - METRIC THREAD | | | FLUSH END - INCHES THREAD | | | BOX QUANTITY PCS/BOX |
|--------------|---------------------------|----------------------|--------------|---------------------------|----------------------|-------------|----------------------|
| | CATALOG NUMBER | ORDERING PART NUMBER | UPC | CATALOG NUMBER | ORDERING PART NUMBER | UPC | |
| 30 | PSR030FL0040 | PSR030FL0040Z | 07945820436 | PSR030FS0040 | PSR030FS0040Z | 07945820451 | 3 pcs/box |
| | PSR030FL0050 | PSR030FL0050Z | 07945820437 | PSR030FS0050 | PSR030FS0050Z | 07945820452 | 3 pcs/box |
| | PSR030FL0063 | PSR030FL0063Z | 07945820438 | PSR030FS0063 | PSR030FS0063Z | 07945820453 | 3 pcs/box |
| | PSR030FL0080 | PSR030FL0080Z | 07945820439 | PSR030FS0080 | PSR030FS0080Z | 07945820454 | 3 pcs/box |
| | PSR030FL0100 | PSR030FL0100Z | 07945820440 | PSR030FS0100 | PSR030FS0100Z | 07945820455 | 3 pcs/box |
| | PSR030FL0125 | PSR030FL0125Z | 07945820441 | PSR030FS0125 | PSR030FS0125Z | 07945820456 | 3 pcs/box |
| | PSR030FL0160 | PSR030FL0160Z | 07945820442 | PSR030FS0160 | PSR030FS0160Z | 07945820457 | 3 pcs/box |
| | PSR030FL0200 | PSR030FL0200Z | 07945820443 | PSR030FS0200 | PSR030FS0200Z | 07945820458 | 3 pcs/box |
| | PSR030FL0250 | PSR030FL0250Z | 07945820444 | PSR030FS0250 | PSR030FS0250Z | 07945820459 | 3 pcs/box |
| | PSR030FL0315 | PSR030FL0315Z | 07945820445 | PSR030FS0315 | PSR030FS0315Z | 07945820460 | 3 pcs/box |
| | PSR030FL0350 | PSR030FL0350Z | 07945820446 | PSR030FS0350 | PSR030FS0350Z | 07945820461 | 3 pcs/box |
| | PSR030FL0400 | PSR030FL0400Z | 07945820447 | PSR030FS0400 | PSR030FS0400Z | 07945820462 | 3 pcs/box |
| | PSR030FL0450 | PSR030FL0450Z | 07945820448 | PSR030FS0450 | PSR030FS0450Z | 07945820463 | 3 pcs/box |
| | PSR030FL0500 | PSR030FL0500Z | 07945820449 | PSR030FS0500 | PSR030FS0500Z | 07945820464 | 3 pcs/box |
| PSR030FL0550 | PSR030FL0550Z | 07945820450 | PSR030FS0550 | PSR030FS0550Z | 07945820465 | 3 pcs/box | |
| PSR030FL0630 | PSR030FL0630Z | 07945827757 | PSR030FS0630 | PSR030FS0630Z | 07945827778 | 3 pcs/box | |
| 31 | PSR031FL0200 | PSR031FL0200Z | 07945820466 | PSR031FS0200 | PSR031FS0200Z | 07945820477 | 3 pcs/box |
| | PSR031FL0250 | PSR031FL0250Z | 07945820467 | PSR031FS0250 | PSR031FS0250Z | 07945820478 | 3 pcs/box |
| | PSR031FL0315 | PSR031FL0315Z | 07945820468 | PSR031FS0315 | PSR031FS0315Z | 07945820479 | 3 pcs/box |
| | PSR031FL0350 | PSR031FL0350Z | 07945820469 | PSR031FS0350 | PSR031FS0350Z | 07945820480 | 3 pcs/box |
| | PSR031FL0400 | PSR031FL0400Z | 07945820470 | PSR031FS0400 | PSR031FS0400Z | 07945820481 | 3 pcs/box |
| | PSR031FL0450 | PSR031FL0450Z | 07945820471 | PSR031FS0450 | PSR031FS0450Z | 07945820482 | 3 pcs/box |
| | PSR031FL0500 | PSR031FL0500Z | 07945820472 | PSR031FS0500 | PSR031FS0500Z | 07945820483 | 3 pcs/box |
| | PSR031FL0550 | PSR031FL0550Z | 07945820473 | PSR031FS0550 | PSR031FS0550Z | 07945820484 | 3 pcs/box |
| | PSR031FL0630 | PSR031FL0630Z | 07945820474 | PSR031FS0630 | PSR031FS0630Z | 07945820485 | 3 pcs/box |
| | PSR031FL0700 | PSR031FL0700Z | 07945820475 | PSR031FS0700 | PSR031FS0700Z | 07945820486 | 3 pcs/box |
| | PSR031FL0800 | PSR031FL0800Z | 07945820476 | PSR031FS0800 | PSR031FS0800Z | 07945820487 | 3 pcs/box |
| | PSR031FL0900 | PSR031FL0900Z | 07945827758 | PSR031FS0900 | PSR031FS0900Z | 07945827779 | 3 pcs/box |
| | PSR032FL0400 | PSR032FL0400Z | 07945820488 | PSR032FS0400 | PSR032FS0400Z | 07945820498 | 3 pcs/box |
| | PSR032FL0450 | PSR032FL0450Z | 07945820489 | PSR032FS0450 | PSR032FS0450Z | 07945820499 | 3 pcs/box |
| PSR032FL0500 | PSR032FL0500Z | 07945820490 | PSR032FS0500 | PSR032FS0500Z | 07945820500 | 3 pcs/box | |
| PSR032FL0550 | PSR032FL0550Z | 07945820491 | PSR032FS0550 | PSR032FS0550Z | 07945820501 | 3 pcs/box | |
| PSR032FL0630 | PSR032FL0630Z | 07945820492 | PSR032FS0630 | PSR032FS0630Z | 07945820502 | 3 pcs/box | |
| PSR032FL0700 | PSR032FL0700Z | 07945820493 | PSR032FS0700 | PSR032FS0700Z | 07945820503 | 3 pcs/box | |
| PSR032FL0800 | PSR032FL0800Z | 07945820494 | PSR032FS0800 | PSR032FS0800Z | 07945820504 | 3 pcs/box | |
| PSR032FL0900 | PSR032FL0900Z | 07945820495 | PSR032FS0900 | PSR032FS0900Z | 07945820505 | 3 pcs/box | |
| PSR032FL1000 | PSR032FL1000Z | 07945820496 | PSR032FS1000 | PSR032FS1000Z | 07945820506 | 3 pcs/box | |
| PSR032FL1100 | PSR032FL1100Z | 07945820497 | PSR032FS1100 | PSR032FS1100Z | 07945820507 | 3 pcs/box | |
| PSR032FL1250 | PSR032FL1250Z | 07945827759 | PSR032FS1250 | PSR032FS1250Z | 07945827780 | 3 pcs/box | |
| PSR032FL1400 | PSR032FL1400Z | 07945827760 | PSR032FS1400 | PSR032FS1400Z | 07945827781 | 3 pcs/box | |
| PSR032FL1500 | PSR032FL1500Z | 07945827761 | PSR032FS1500 | PSR032FS1500Z | 07945827782 | 3 pcs/box | |
| 33 | PSR033FL0450 | PSR033FL0450Z | 07945822163 | PSR033FS0450 | PSR033FS0450Z | 07945822164 | 3 pcs/box |
| | PSR033FL0500 | PSR033FL0500Z | 07945820508 | PSR033FS0500 | PSR033FS0500Z | 07945820522 | 3 pcs/box |
| | PSR033FL0550 | PSR033FL0550Z | 07945820509 | PSR033FS0550 | PSR033FS0550Z | 07945820523 | 3 pcs/box |
| | PSR033FL0630 | PSR033FL0630Z | 07945820510 | PSR033FS0630 | PSR033FS0630Z | 07945820524 | 3 pcs/box |
| | PSR033FL0700 | PSR033FL0700Z | 07945820511 | PSR033FS0700 | PSR033FS0700Z | 07945820525 | 3 pcs/box |
| | PSR033FL0800 | PSR033FL0800Z | 07945820512 | PSR033FS0800 | PSR033FS0800Z | 07945820526 | 3 pcs/box |
| | PSR033FL0900 | PSR033FL0900Z | 07945820513 | PSR033FS0900 | PSR033FS0900Z | 07945820527 | 3 pcs/box |
| | PSR033FL1000 | PSR033FL1000Z | 07945820514 | PSR033FS1000 | PSR033FS1000Z | 07945820528 | 3 pcs/box |
| | PSR033FL1100 | PSR033FL1100Z | 07945820515 | PSR033FS1100 | PSR033FS1100Z | 07945820529 | 3 pcs/box |
| | PSR033FL1250 | PSR033FL1250Z | 07945820516 | PSR033FS1250 | PSR033FS1250Z | 07945820530 | 3 pcs/box |
| | PSR033FL1400 | PSR033FL1400Z | 07945820517 | PSR033FS1400 | PSR033FS1400Z | 07945820531 | 3 pcs/box |
| | PSR033FL1500 | PSR033FL1500Z | 07945820518 | PSR033FS1500 | PSR033FS1500Z | 07945820532 | 3 pcs/box |
| | PSR033FL1600 | PSR033FL1600Z | 07945820519 | PSR033FS1600 | PSR033FS1600Z | 07945820533 | 3 pcs/box |
| | PSR033FL1800 | PSR033FL1800Z | 07945820520 | PSR033FS1800 | PSR033FS1800Z | 07945820534 | 3 pcs/box |
| | PSR033FL2000 | PSR033FL2000Z | 07945820521 | PSR033FS2000 | PSR033FS2000Z | 07945820535 | 3 pcs/box |
| | PSR033FL2250 | PSR033FL2250Z | 07945827762 | PSR033FS2250 | PSR033FS2250Z | 07945827783 | 3 pcs/box |

POWR-SPEED® Fuse

PSR Series High-Speed Square Body

Ordering Information (Continued)

| CASE SIZE | FLUSH END - METRIC THREAD | | | FLUSH END - INCHES THREAD | | | BOX QUANTITY PCS/BOX |
|--------------|---------------------------|----------------------|--------------|---------------------------|----------------------|-------------|----------------------|
| | CATALOG NUMBER | ORDERING PART NUMBER | UPC | CATALOG NUMBER | ORDERING PART NUMBER | UPC | |
| 70 | PSR070FL0050 | PSR070FL0050Z | 07945820536 | PSR070FS0050 | PSR070FS0050Z | 07945820546 | 2 pcs/box |
| | PSR070FL0063 | PSR070FL0063Z | 07945820537 | PSR070FS0063 | PSR070FS0063Z | 07945820547 | 2 pcs/box |
| | PSR070FL0080 | PSR070FL0080Z | 07945820538 | PSR070FS0080 | PSR070FS0080Z | 07945820548 | 2 pcs/box |
| | PSR070FL0100 | PSR070FL0100Z | 07945820539 | PSR070FS0100 | PSR070FS0100Z | 07945820549 | 2 pcs/box |
| | PSR070FL0125 | PSR070FL0125Z | 07945820540 | PSR070FS0125 | PSR070FS0125Z | 07945820550 | 2 pcs/box |
| | PSR070FL0160 | PSR070FL0160Z | 07945820541 | PSR070FS0160 | PSR070FS0160Z | 07945820551 | 2 pcs/box |
| | PSR070FL0200 | PSR070FL0200Z | 07945820542 | PSR070FS0200 | PSR070FS0200Z | 07945820552 | 2 pcs/box |
| | PSR070FL0250 | PSR070FL0250Z | 07945820543 | PSR070FS0250 | PSR070FS0250Z | 07945820553 | 2 pcs/box |
| | PSR070FL0280 | PSR070FL0280Z | 07945820544 | PSR070FS0280 | PSR070FS0280Z | 07945820554 | 2 pcs/box |
| | PSR070FL0315 | PSR070FL0315Z | 07945820545 | PSR070FS0315 | PSR070FS0315Z | 07945820555 | 2 pcs/box |
| | PSR070FL0350 | PSR070FL0350Z | 07945827763 | PSR070FS0350 | PSR070FS0350Z | 07945827784 | 2 pcs/box |
| PSR070FL0400 | PSR070FL0400Z | 07945827764 | PSR070FS0400 | PSR070FS0400Z | 07945827785 | 2 pcs/box | |
| 71 | PSR071FL0160 | PSR071FL0160Z | 07945820556 | PSR071FS0160 | PSR071FS0160Z | 07945820564 | 2 pcs/box |
| | PSR071FL0200 | PSR071FL0200Z | 07945820557 | PSR071FS0200 | PSR071FS0200Z | 07945820565 | 2 pcs/box |
| | PSR071FL0250 | PSR071FL0250Z | 07945820558 | PSR071FS0250 | PSR071FS0250Z | 07945820566 | 2 pcs/box |
| | PSR071FL0280 | PSR071FL0280Z | 07945820573 | PSR071FS0280 | PSR071FS0280Z | 07945820582 | 2 pcs/box |
| | PSR071FL0315 | PSR071FL0315Z | 07945820560 | PSR071FS0315 | PSR071FS0315Z | 07945820568 | 2 pcs/box |
| | PSR071FL0350 | PSR071FL0350Z | 07945820561 | PSR071FS0350 | PSR071FS0350Z | 07945820569 | 2 pcs/box |
| | PSR071FL0400 | PSR071FL0400Z | 07945820562 | PSR071FS0400 | PSR071FS0400Z | 07945820570 | 2 pcs/box |
| | PSR071FL0450 | PSR071FL0450Z | 07945820563 | PSR071FS0450 | PSR071FS0450Z | 07945820571 | 2 pcs/box |
| | PSR071FL0500 | PSR071FL0500Z | 07945827765 | PSR071FS0500 | PSR071FS0500Z | 07945827786 | 2 pcs/box |
| | PSR071FL0550 | PSR071FL0550Z | 07945827766 | PSR071FS0550 | PSR071FS0550Z | 07945827787 | 2 pcs/box |
| | PSR071FL0630 | PSR071FL0630Z | 07945827767 | PSR071FS0630 | PSR071FS0630Z | 07945827788 | 2 pcs/box |
| 72 | PSR072FL0250 | PSR072FL0250Z | 07945820572 | PSR072FS0250 | PSR072FS0250Z | 07945820581 | 2 pcs/box |
| | PSR072FL0280 | PSR072FL0280Z | 07945820573 | PSR072FS0280 | PSR072FS0280Z | 07945820582 | 2 pcs/box |
| | PSR072FL0315 | PSR072FL0315Z | 07945820574 | PSR072FS0315 | PSR072FS0315Z | 07945820583 | 2 pcs/box |
| | PSR072FL0350 | PSR072FL0350Z | 07945820575 | PSR072FS0350 | PSR072FS0350Z | 07945820584 | 2 pcs/box |
| | PSR072FL0400 | PSR072FL0400Z | 07945820576 | PSR072FS0400 | PSR072FS0400Z | 07945820585 | 2 pcs/box |
| | PSR072FL0450 | PSR072FL0450Z | 07945820577 | PSR072FS0450 | PSR072FS0450Z | 07945820586 | 2 pcs/box |
| | PSR072FL0500 | PSR072FL0500Z | 07945820578 | PSR072FS0500 | PSR072FS0500Z | 07945820587 | 2 pcs/box |
| | PSR072FL0550 | PSR072FL0550Z | 07945820579 | PSR072FS0550 | PSR072FS0550Z | 07945820588 | 2 pcs/box |
| | PSR072FL0630 | PSR072FL0630Z | 07945820580 | PSR072FS0630 | PSR072FS0630Z | 07945820589 | 2 pcs/box |
| | PSR072FL0700 | PSR072FL0700Z | 07945827768 | PSR072FS0700 | PSR072FS0700Z | 07945827789 | 2 pcs/box |
| | PSR072FL0800 | PSR072FL0800Z | 07945827769 | PSR072FS0800 | PSR072FS0800Z | 07945827790 | 2 pcs/box |
| | PSR072FL0900 | PSR072FL0900Z | 07945827770 | PSR072FS0900 | PSR072FS0900Z | 07945827793 | 2 pcs/box |
| | PSR072FL1000 | PSR072FL1000Z | 07945827771 | PSR072FS1000 | PSR072FS1000Z | 07945827794 | 2 pcs/box |
| 73 | PSR073FL0315 | PSR073FL0315Z | 07945820590 | PSR073FS0315 | PSR073FS0315Z | 07945820602 | 2 pcs/box |
| | PSR073FL0350 | PSR073FL0350Z | 07945820591 | PSR073FS0350 | PSR073FS0350Z | 07945820603 | 2 pcs/box |
| | PSR073FL0400 | PSR073FL0400Z | 07945820592 | PSR073FS0400 | PSR073FS0400Z | 07945820604 | 2 pcs/box |
| | PSR073FL0450 | PSR073FL0450Z | 07945820593 | PSR073FS0450 | PSR073FS0450Z | 07945820605 | 2 pcs/box |
| | PSR073FL0500 | PSR073FL0500Z | 07945820594 | PSR073FS0500 | PSR073FS0500Z | 07945820606 | 2 pcs/box |
| | PSR073FL0550 | PSR073FL0550Z | 07945820595 | PSR073FS0550 | PSR073FS0550Z | 07945820607 | 2 pcs/box |
| | PSR073FL0630 | PSR073FL0630Z | 07945820596 | PSR073FS0630 | PSR073FS0630Z | 07945820608 | 2 pcs/box |
| | PSR073FL0700 | PSR073FL0700Z | 07945820597 | PSR073FS0700 | PSR073FS0700Z | 07945820609 | 2 pcs/box |
| | PSR073FL0800 | PSR073FL0800Z | 07945827772 | PSR073FS0800 | PSR073FS0800Z | 07945827795 | 2 pcs/box |
| | PSR073FL0900 | PSR073FL0900Z | 07945827773 | PSR073FS0900 | PSR073FS0900Z | 07945827796 | 2 pcs/box |
| | PSR073FL1000 | PSR073FL1000Z | 07945827774 | PSR073FS1000 | PSR073FS1000Z | 07945827797 | 2 pcs/box |
| | PSR073FL1100 | PSR073FL1100Z | 07945827775 | PSR073FS1100 | PSR073FS1100Z | 07945827798 | 2 pcs/box |
| | PSR073FL1250 | PSR073FL1250Z | 07945827776 | PSR073FS1250 | PSR073FS1250Z | 07945827799 | 2 pcs/box |
| | PSR073FL1400 | PSR073FL1400Z | 07945827777 | PSR073FS1400 | PSR073FS1400Z | 07945827800 | 2 pcs/box |

POWR-SPEED® Fuse

PSR Series High-Speed Square Body

Dimensions

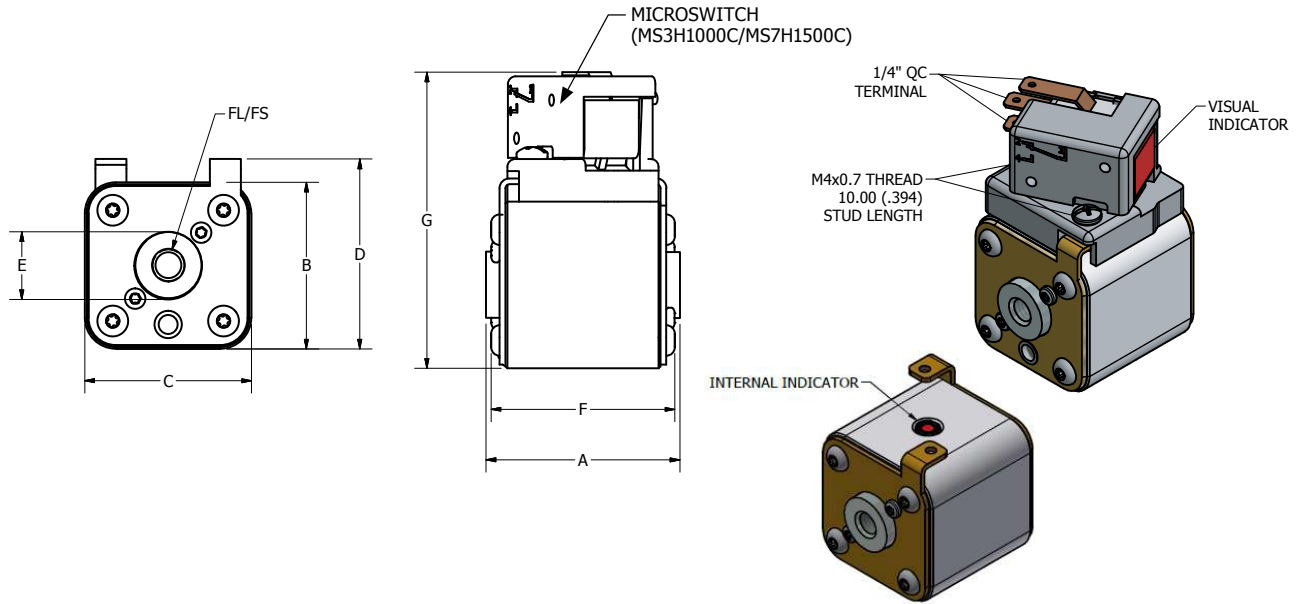

DIMENSIONS IN MM (IN)

| CASE SIZE | A | B | C | D | E | F | G | FL METRIC THREAD | FS INCHES THREAD | RECOMMENDED TORQUE |
|-----------|-------------|-------------|-------------|-------------|------------|-------------|--------------|------------------|------------------|--------------------|
| 30 | 50.0 (1.97) | 43.0 (1.69) | 43.0 (1.69) | 49.0 (1.93) | 17.0 (0.7) | 47.7 (1.88) | 77.9 (3.07) | M8 x 1.25 | 5/16"-18 UNC 2B | 13-20 Nm |
| 31 | 50.0 (1.97) | 51.5 (2.03) | 51.5 (2.03) | 57.5 (2.26) | 20.0 (0.8) | 48.5 (1.91) | 86.4 (3.40) | M8 x 1.25 | 5/16"-18 UNC 2B | 13-20 Nm |
| 32 | 51.0 (2.01) | 60.0 (2.36) | 60.0 (2.36) | 66.0 (2.60) | 23.0 (0.9) | 49.2 (1.94) | 94.9 (3.74) | M10 x 1.5 | 3/8"-16 UNC 2B | 26-35 Nm |
| 33 | 51.0 (2.01) | 73.5 (2.89) | 73.5 (2.89) | 79.5 (3.13) | 30.0 (1.2) | 49.5 (1.95) | 108.4 (4.27) | M12 x 1.75 | 1/2"-13 UNC 2B | 45-55 Nm |
| 70 | 74.0 (2.91) | 43.0 (1.69) | 43.0 (1.69) | 49.0 (1.93) | 17.0 (0.7) | 71.7 (2.82) | 77.9 (3.07) | M8 x 1.25 | 5/16"-18 UNC 2B | 13-20 Nm |
| 71 | 74.0 (2.91) | 51.5 (2.03) | 51.5 (2.03) | 57.5 (2.26) | 20.0 (0.8) | 72.5 (2.85) | 86.4 (3.40) | M8 x 1.25 | 5/16"-18 UNC 2B | 13-20 Nm |
| 72 | 75.0 (2.95) | 60.0 (2.36) | 60.0 (2.36) | 66.0 (2.60) | 23.0 (0.9) | 73.2 (2.88) | 94.9 (3.736) | M10 x 1.5 | 3/8"-16 UNC 2B | 26-35 Nm |
| 73 | 75.0 (2.95) | 73.5 (2.89) | 73.5 (2.89) | 79.5 (3.13) | 30.0 (1.2) | 73.5 (2.89) | 108.4 (4.27) | M12 x 1.75 | 1/2"-13 UNC 2B | 45-55 Nm |

Recommended mounting

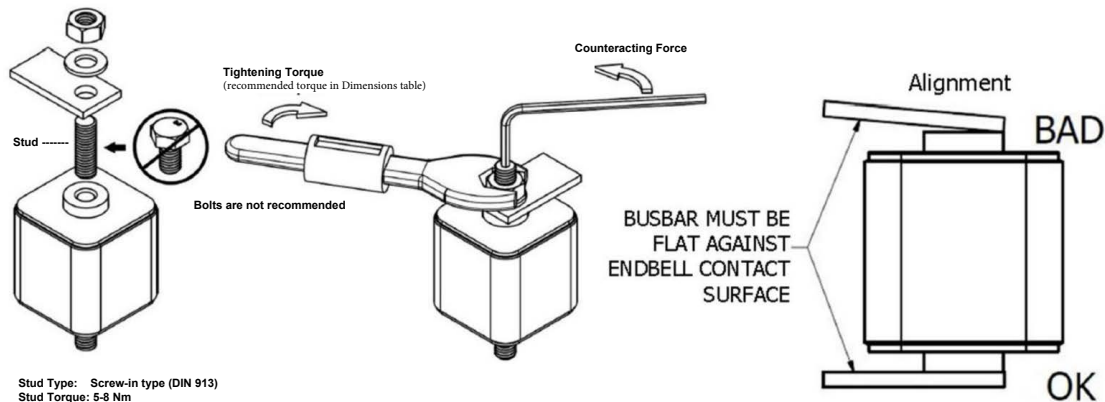

POWR-SPEED® Fuse

PSR Series High-Speed Square Body

Time Current Curve (30 Case Size)

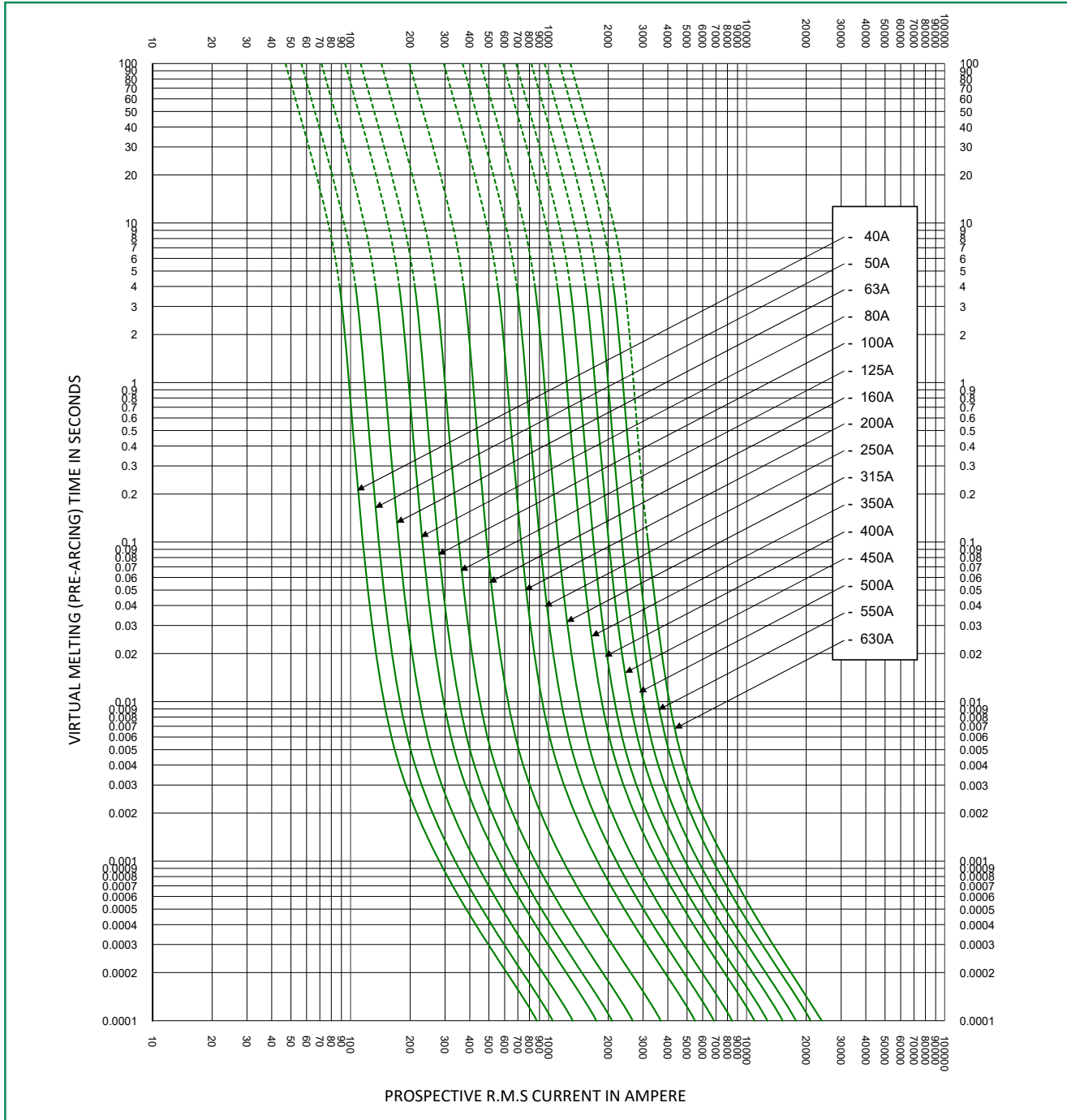

* Dc minimum breaking capacity = 9 x rated current of fuse

POWR-SPEED® Fuse

PSR Series High-Speed Square Body

Time Current Curve (31 Case Size)

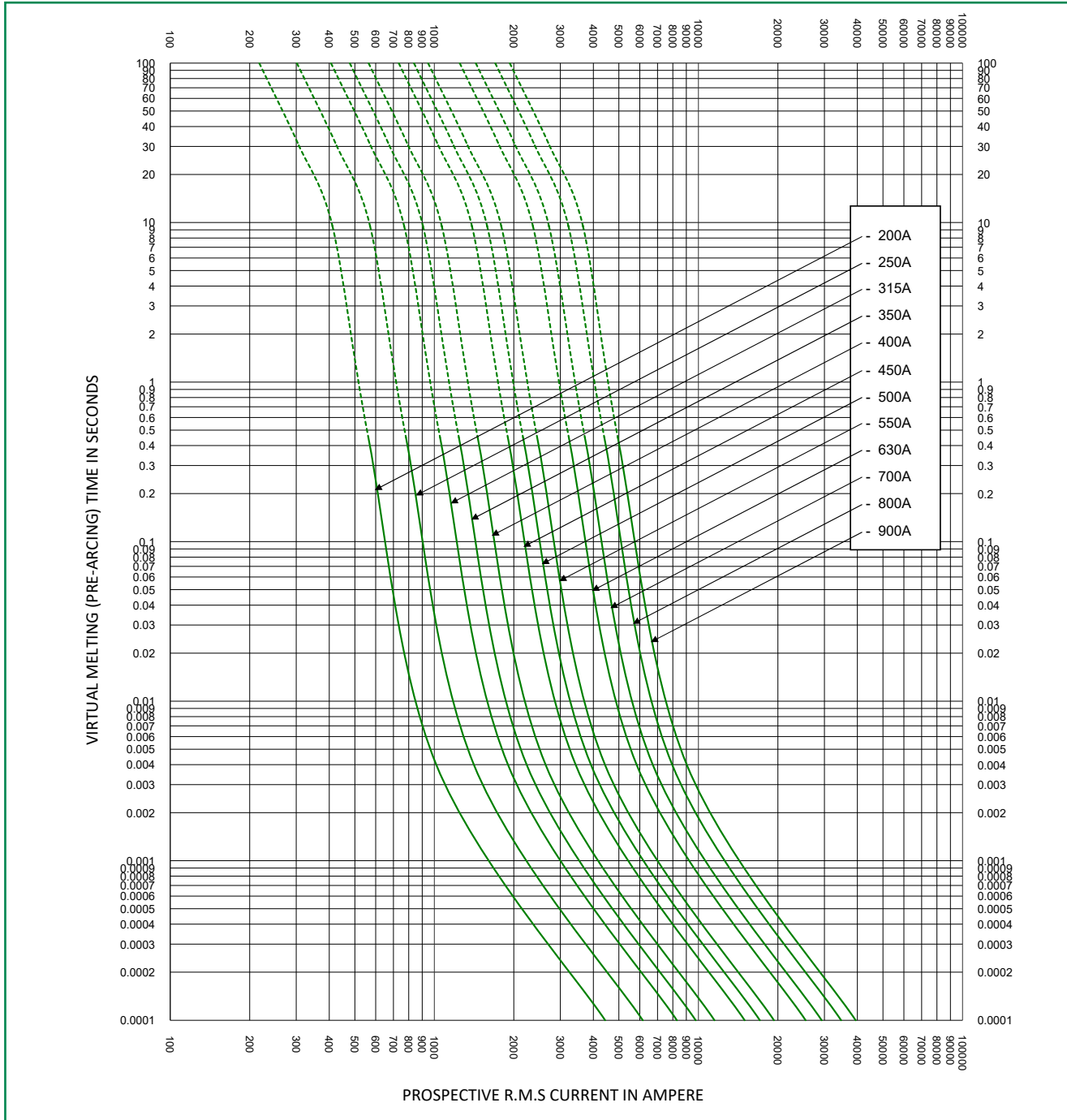

* Dc minimum breaking capacity = 9 x rated current of fuse

POWR-SPEED® Fuse

PSR Series High-Speed Square Body

Time Current Curve (32 Case Size)

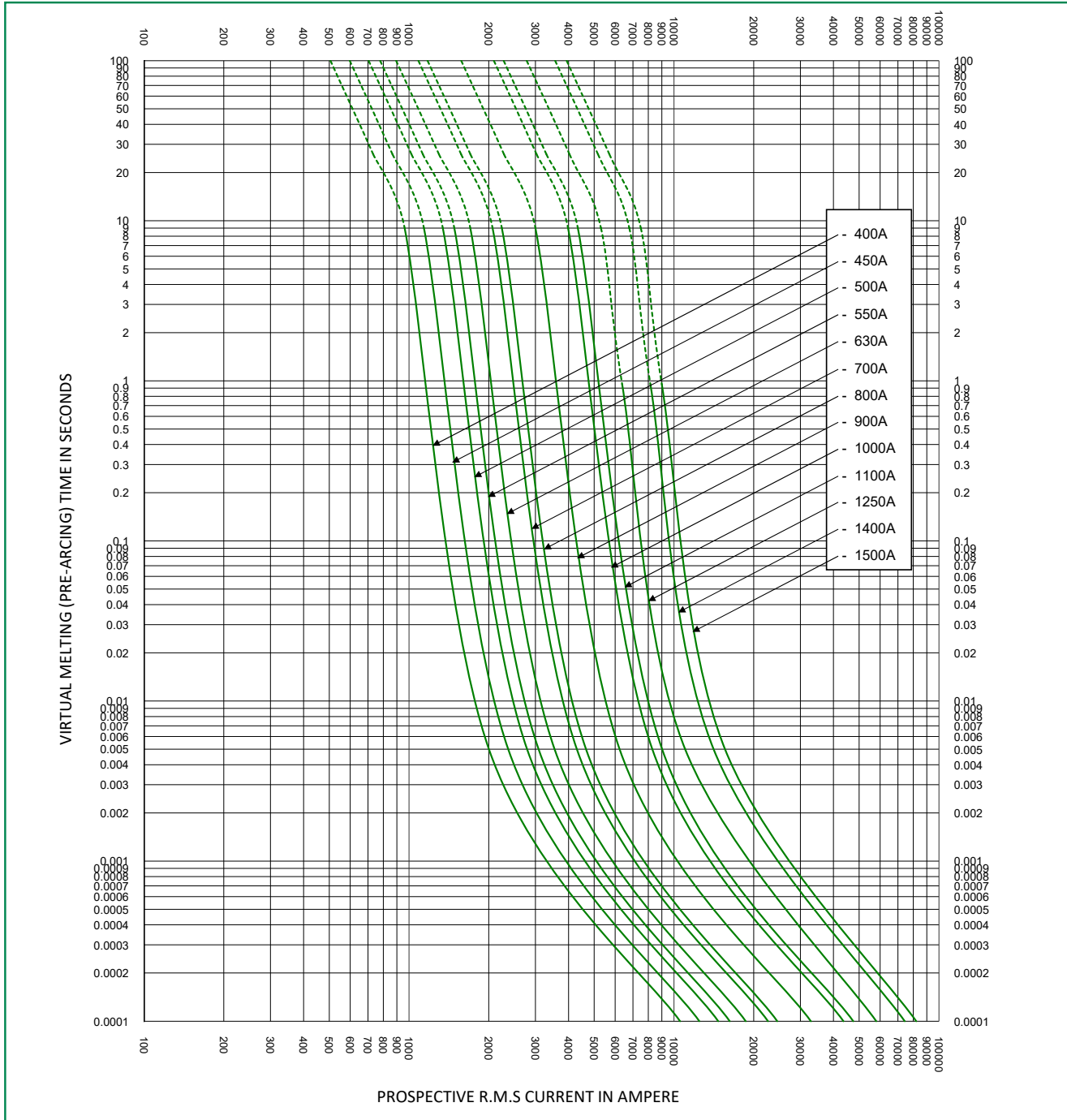

* Dc minimum breaking capacity = 9 x rated current of fuse

POWR-SPEED® Fuse

PSR Series High-Speed Square Body

Time Current Curve (33 Case Size)

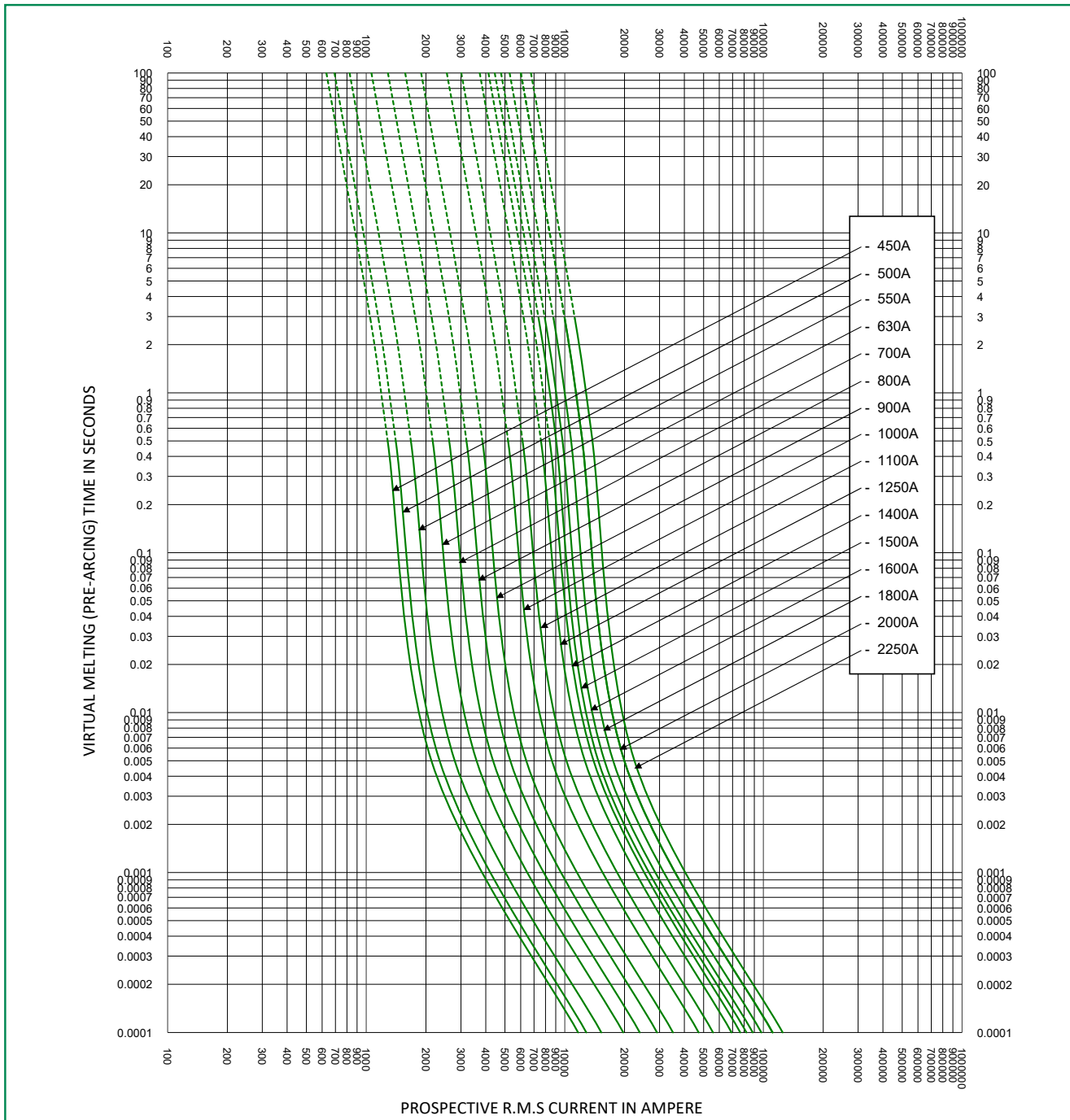

* Dc minimum breaking capacity = 9 x rated current of fuse

POWR-SPEED® Fuse

PSR Series High-Speed Square Body

Time Current Curve (70 Case Size)

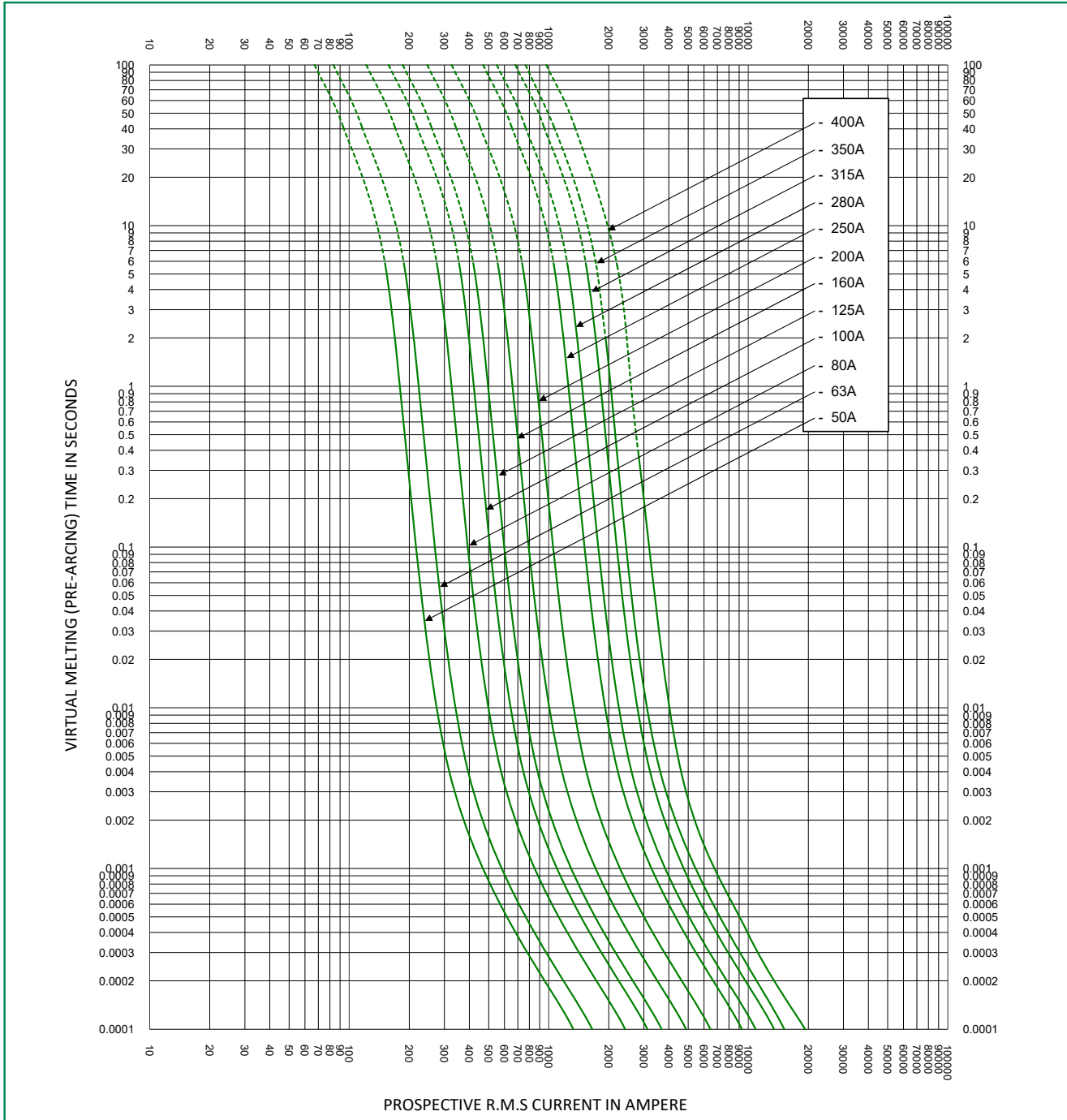

* Dc minimum breaking capacity = 9 x rated current of fuse

POWR-SPEED® Fuse

PSR Series High-Speed Square Body

Time Current Curve (71 Case Size)

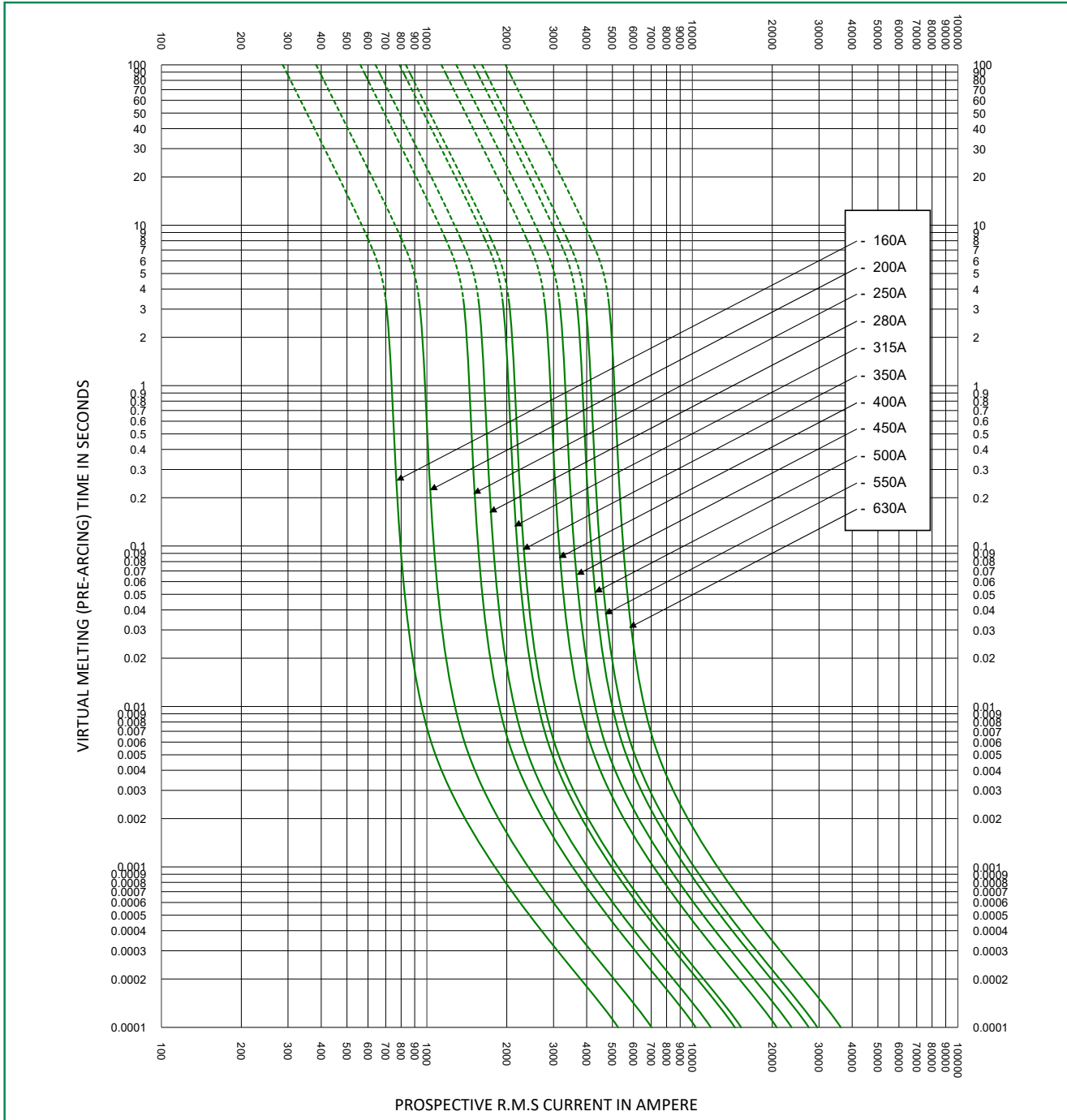

* Dc minimum breaking capacity = 9 x rated current of fuse

POWR-SPEED® Fuse

PSR Series High-Speed Square Body

Time Current Curve (72 Case Size)

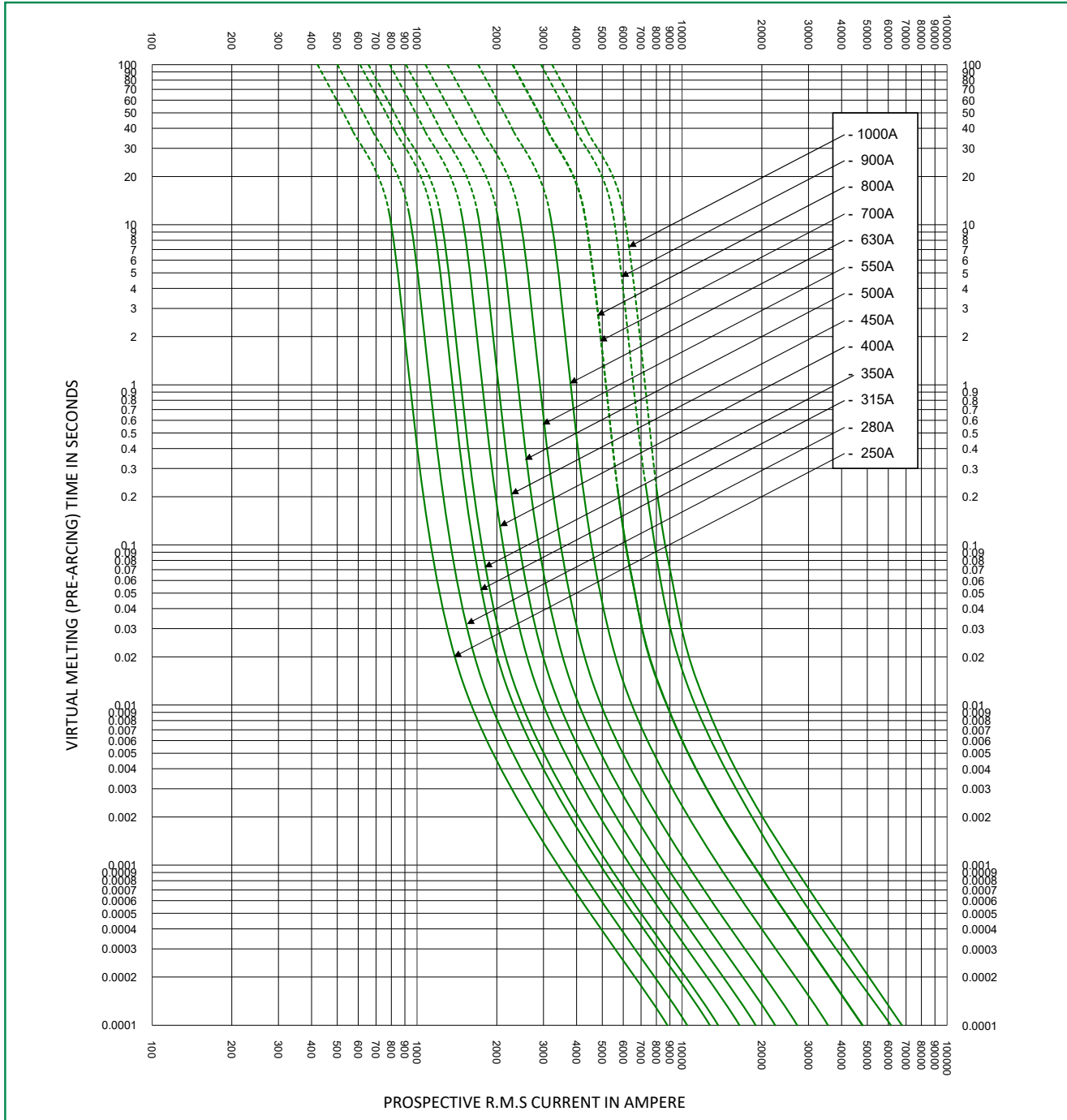

* Dc minimum breaking capacity = 9 x rated current of fuse

POWR-SPEED® Fuse

PSR Series High-Speed Square Body

Time Current Curve (73 Case Size)

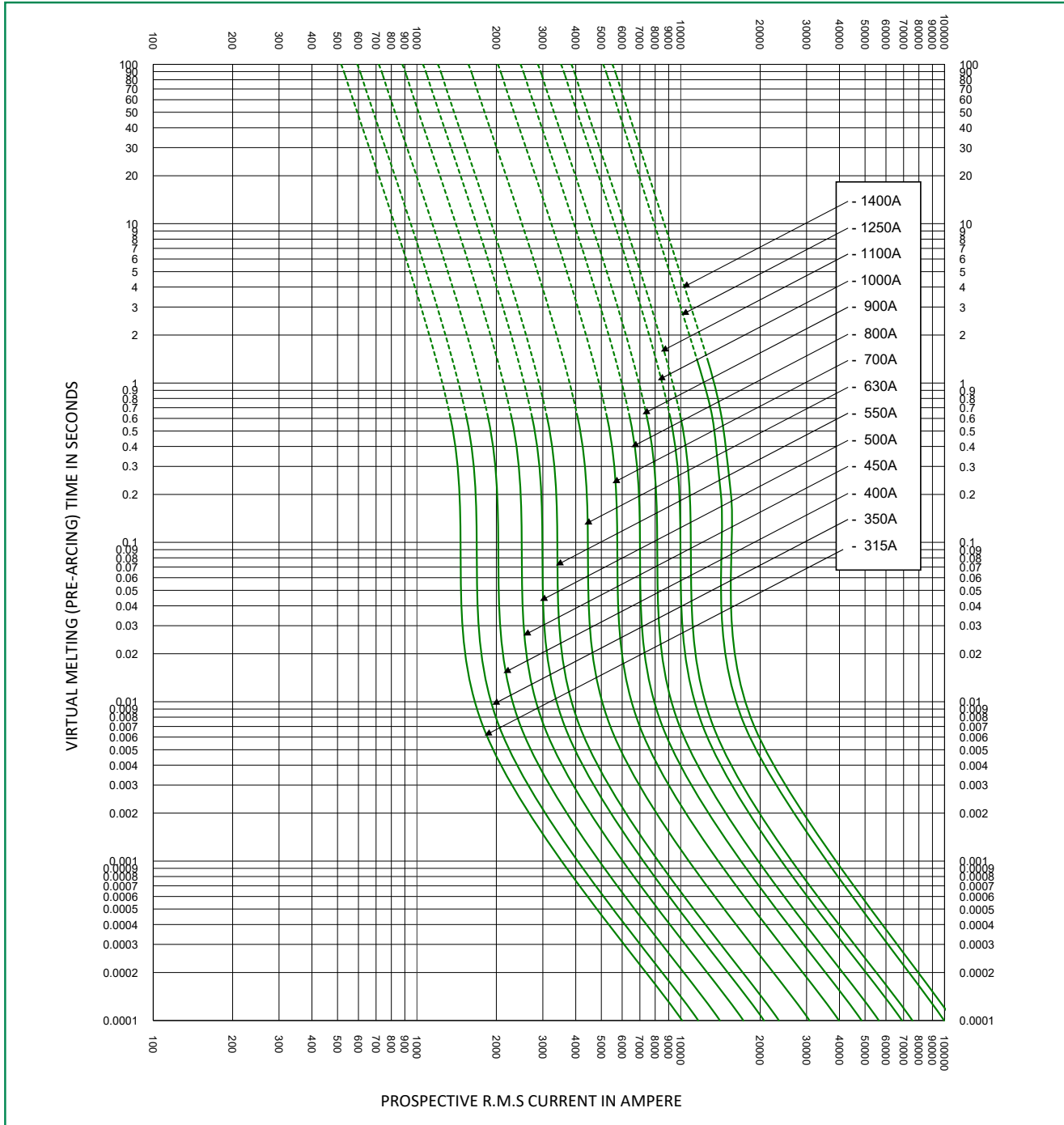

* Dc minimum breaking capacity = 9 x rated current of fuse

Peak Let-Thru Curve (30 Case Size)

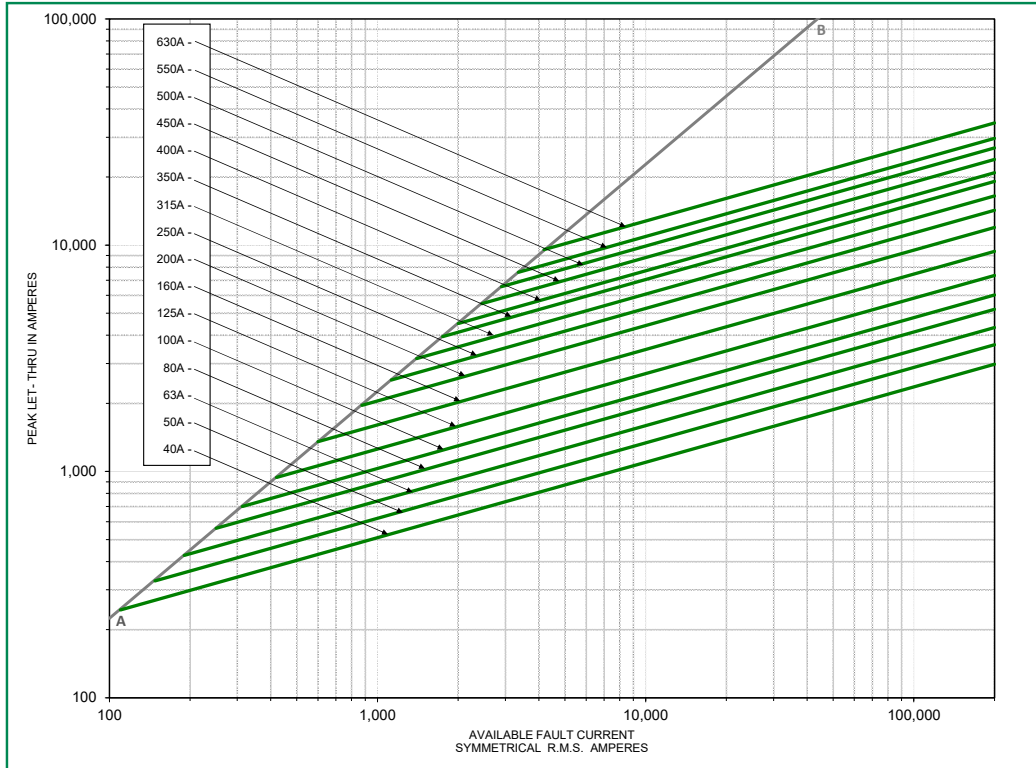

Peak Let-Thru Curve (31 Case Size)

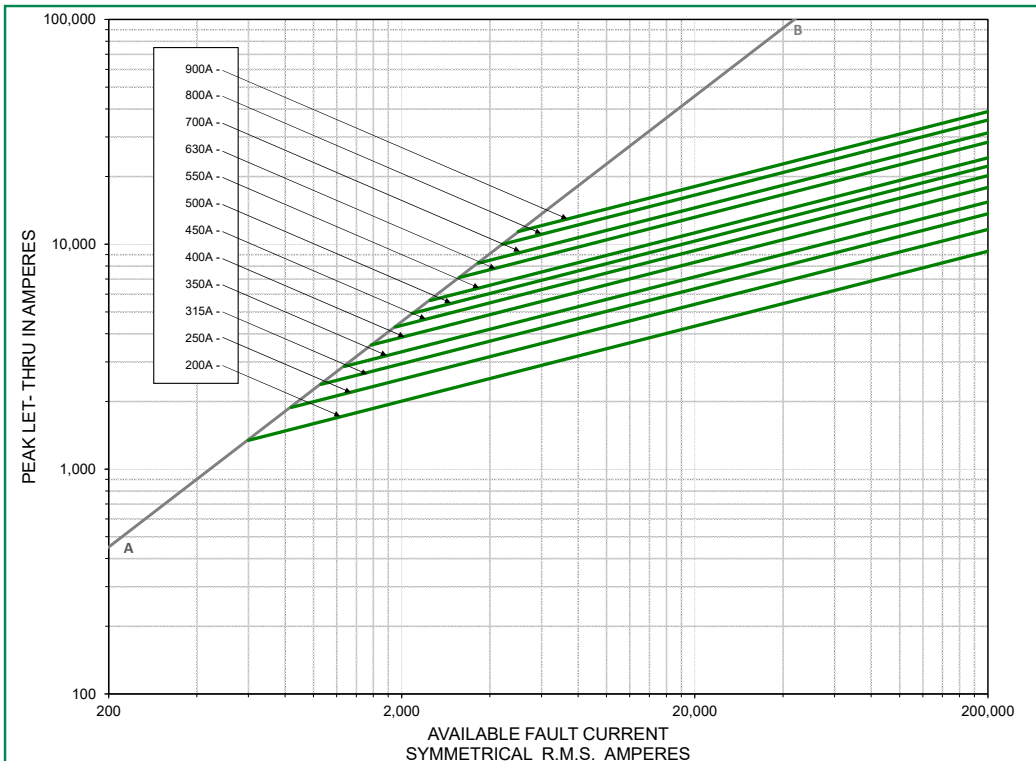

Peak Let-Thru Curve (32 Case Size)

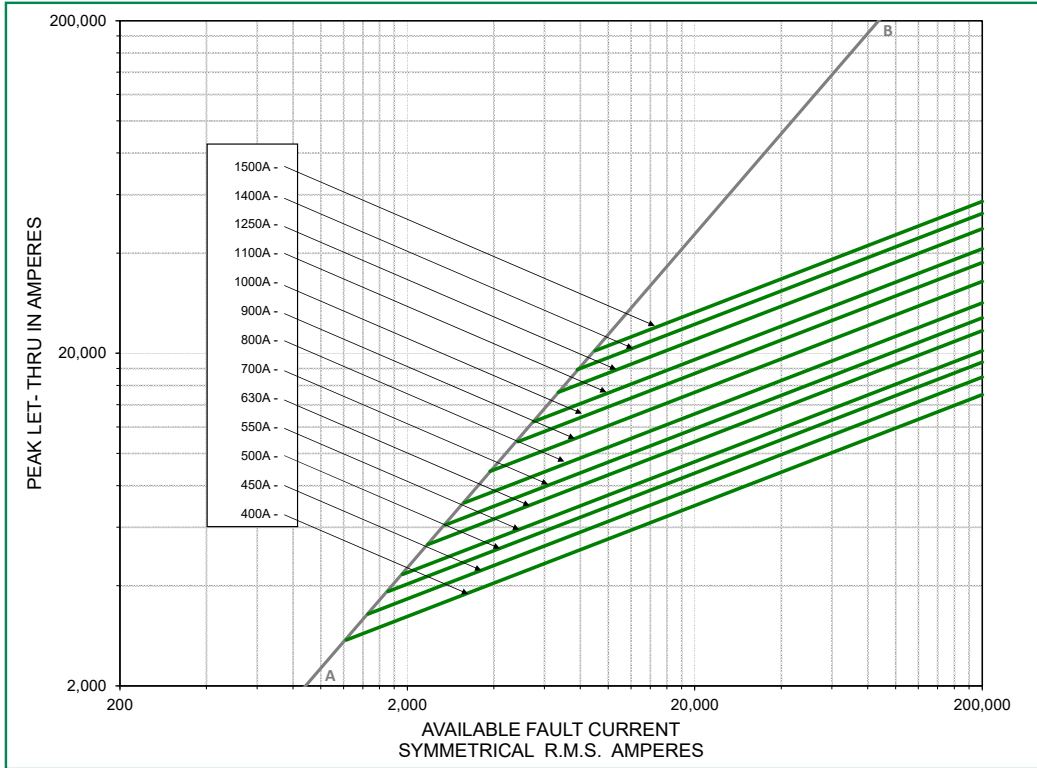

Peak Let-Thru Curve (33 Case Size)

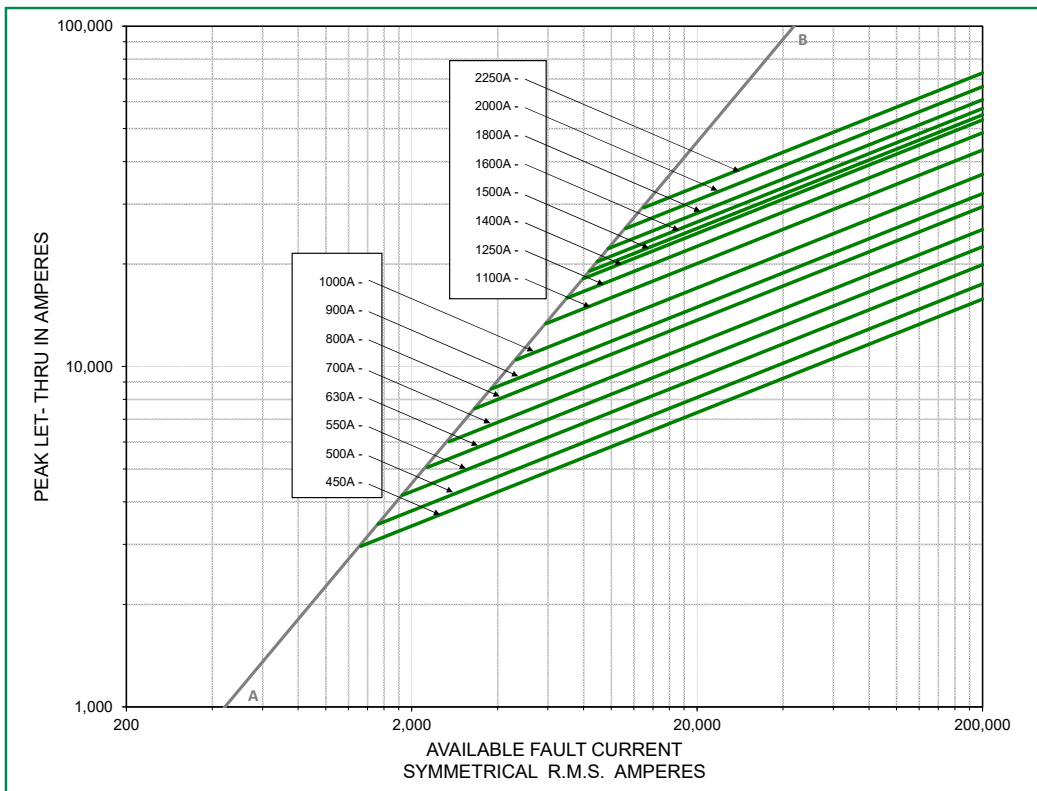

Peak Let-Thru Curve (70 Case Size)

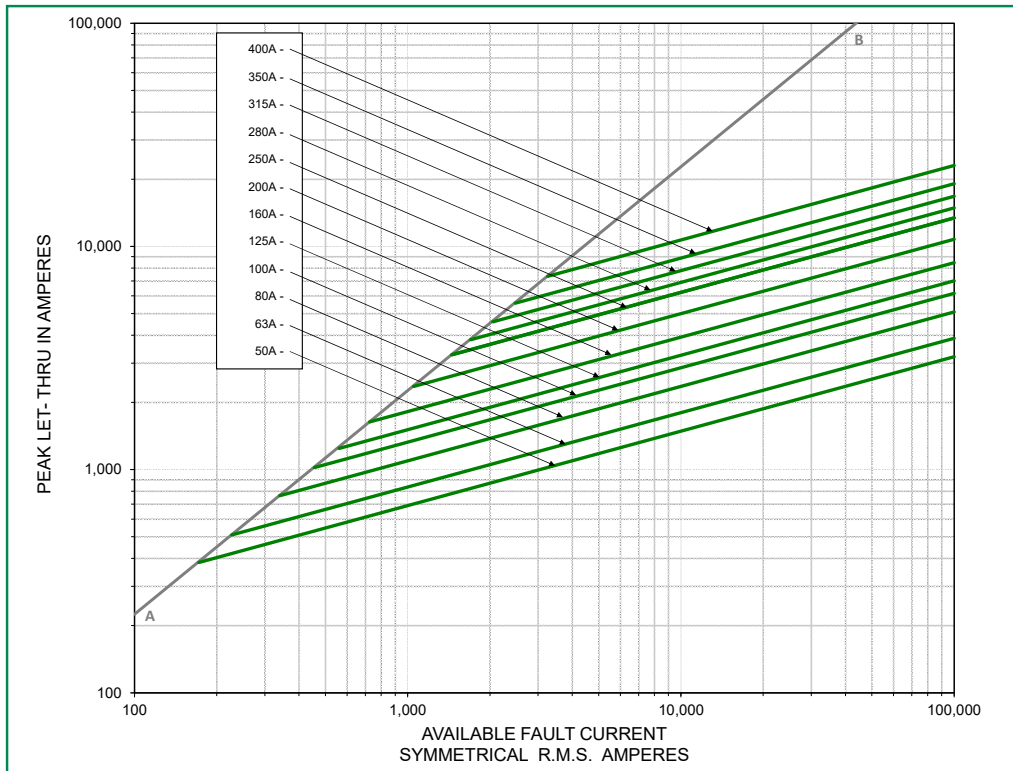

Peak Let-Thru Curve (71 Case Size)

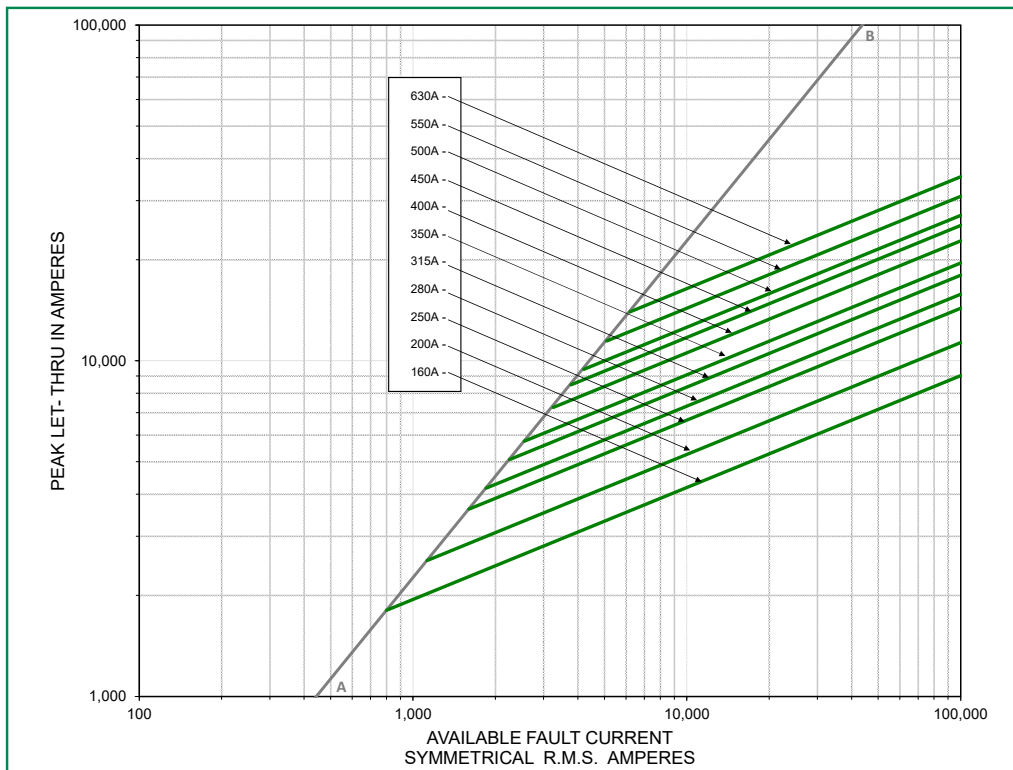

Peak Let-Thru Curve (72 Case Size)

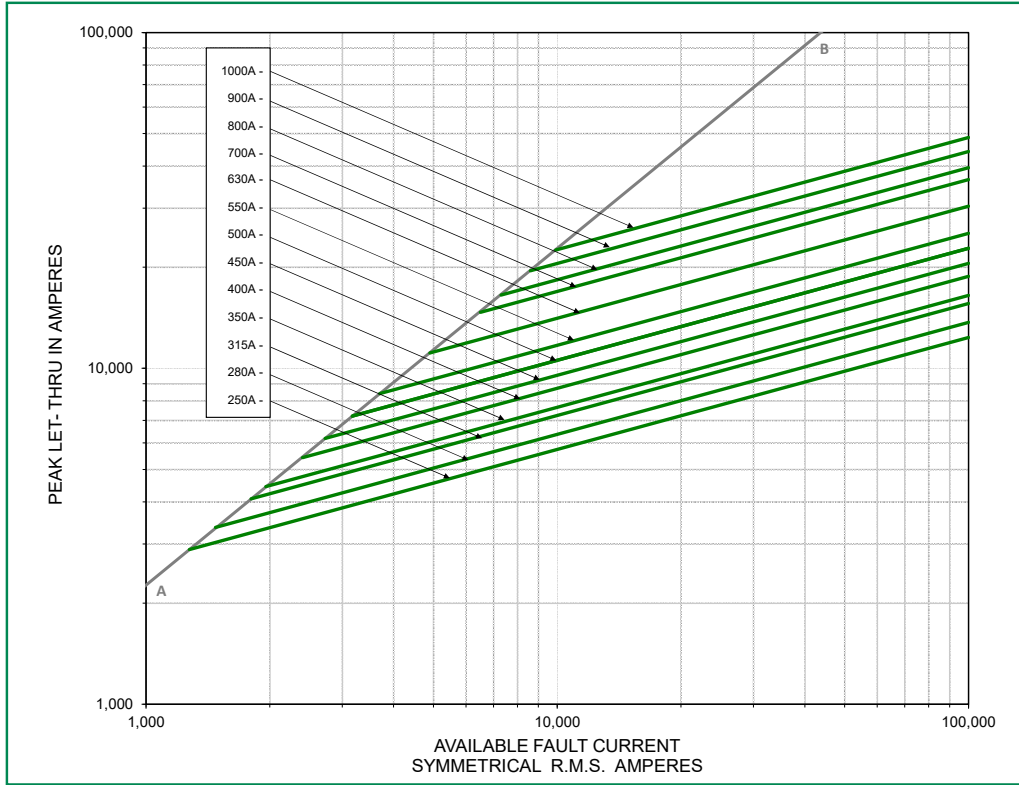

Peak Let-Thru Curve (73 Case Size)

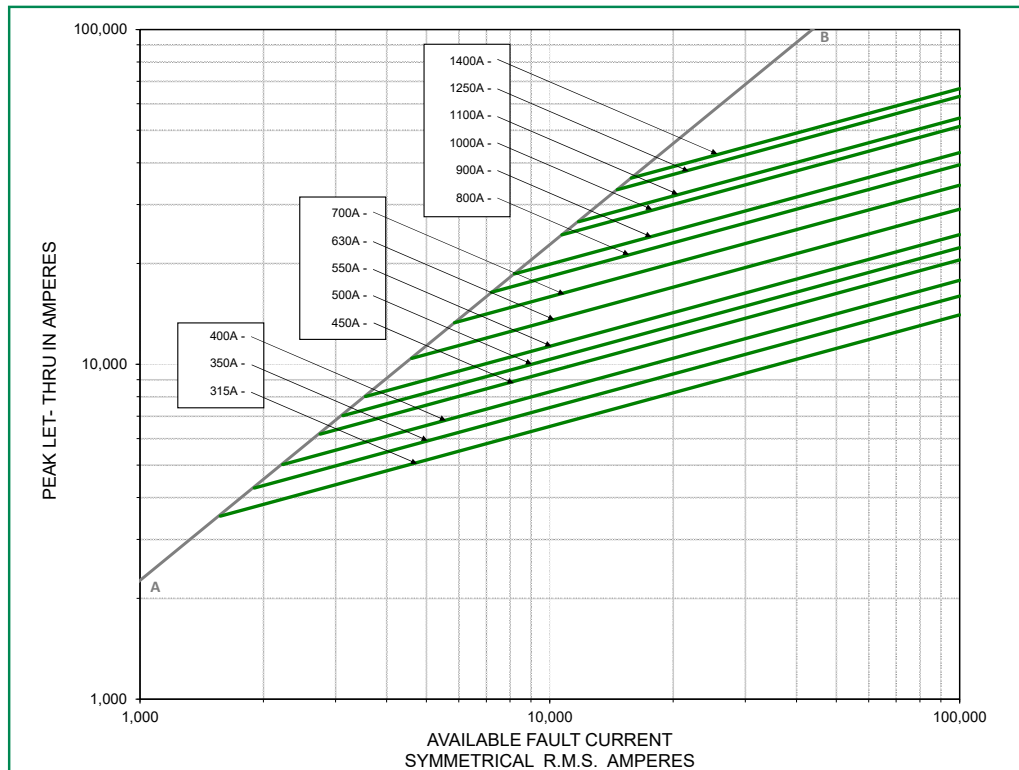

POWR-SPEED® Fuse

PSR Series High-Speed Square Body

Total Clearing I²t Correction Factor Curve
(30, 31, 32 and 33 Case Sizes)

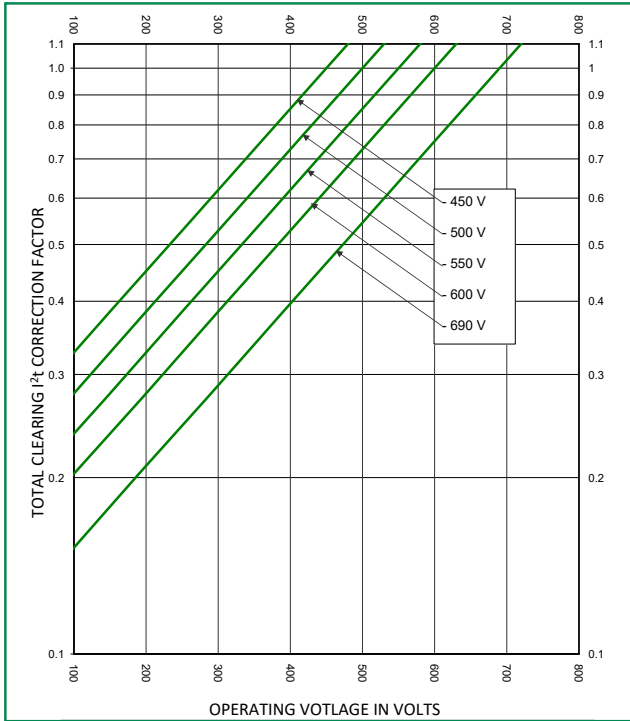

Total Clearing I²t Correction Factor Curve
(70, 71, 72 and 73 Case Sizes)

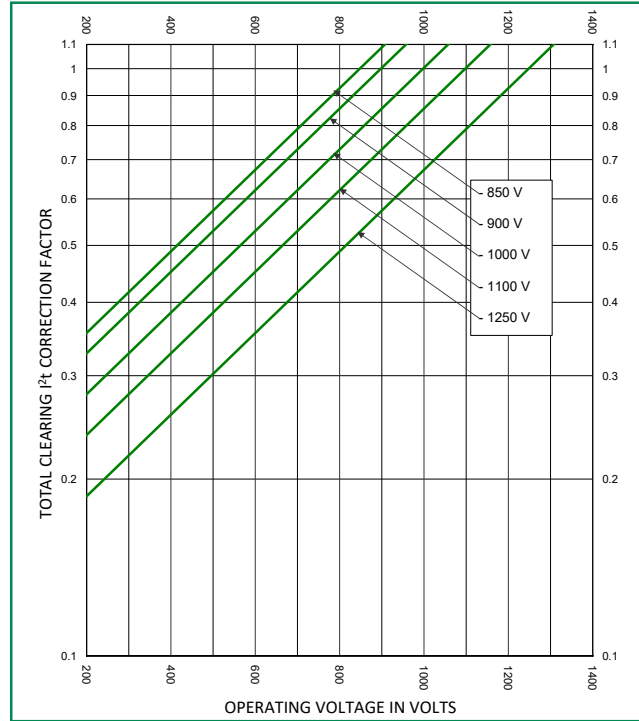

Peak Arc Voltage Curve
(30, 31, 32 and 33 Case Sizes)

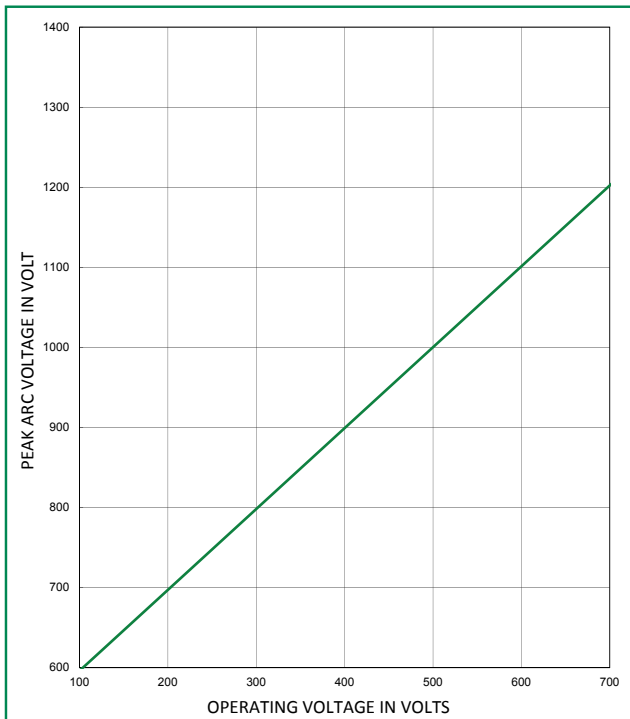

Peak Arc Voltage Curve
(70, 71, 72 and 73 Case Sizes)

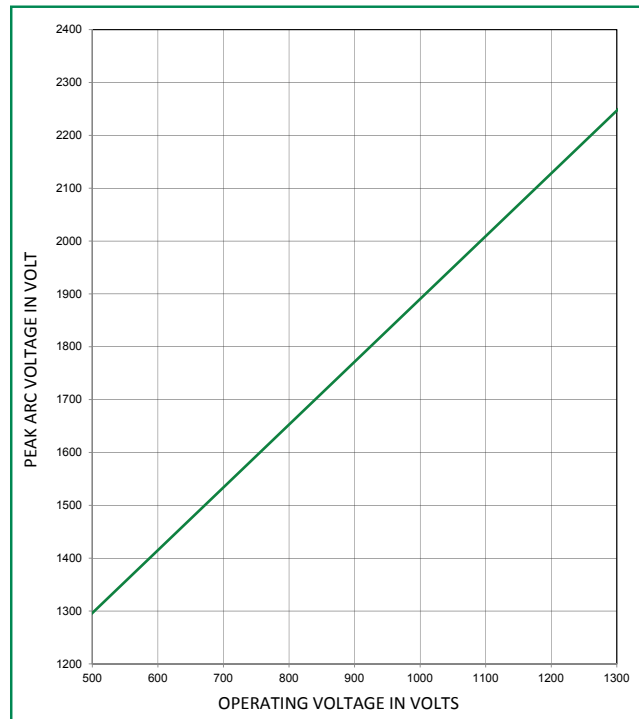

POWR-SPEED® Fuse

PSR Series High-Speed Square Body

Temperature Derating Curve (temperature of air immediately surrounding fuse)

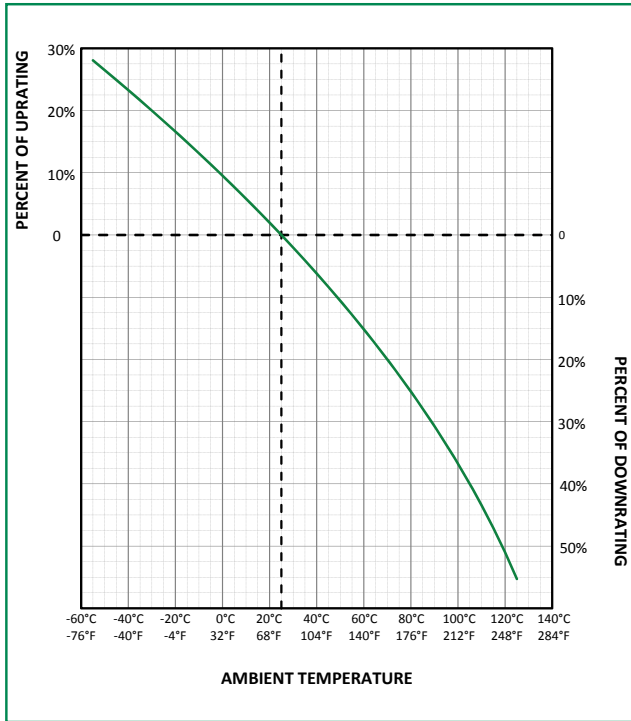

Watts Loss Correction Factor Curve

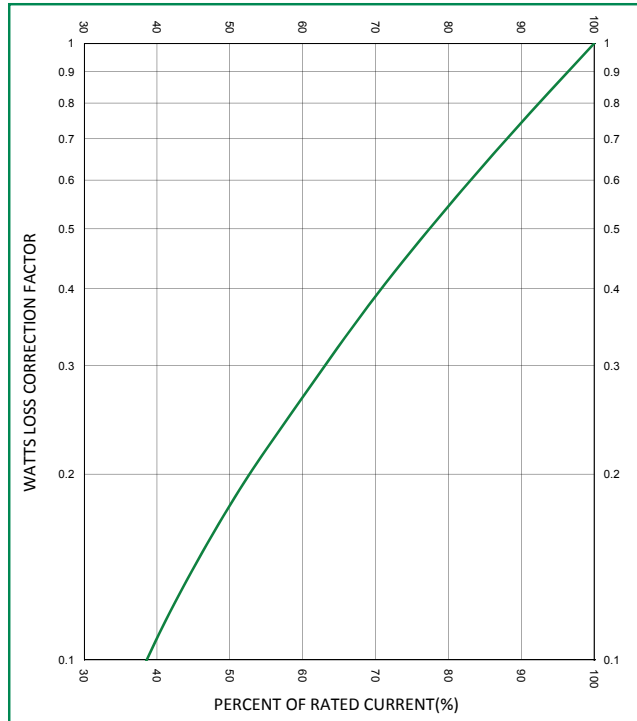

Disclaimer Notice – Information furnished is believed to be accurate and reliable. However, users should independently evaluate the suitability of and test each product selected for their own applications. Littelfuse products are not designed for, and may not be used in, all applications. Read complete Disclaimer Notice at www.littelfuse.com/product-disclaimer.