

Smallest book-style EMC/RFI Filter for Inverter and Power Drive Systems



- Standard and high performance EMC solution
- Best in class performance at 9kHz and beyond
- Footprint space-saving book-style housing
- Solid safety connector blocks
- High attenuation performance FN3288, standard performance available FN3287
- HV versions for 690 VAC applications, HVIT- and IT versions for IT distribution networks
- SCCR 100 kA



Performance indicators

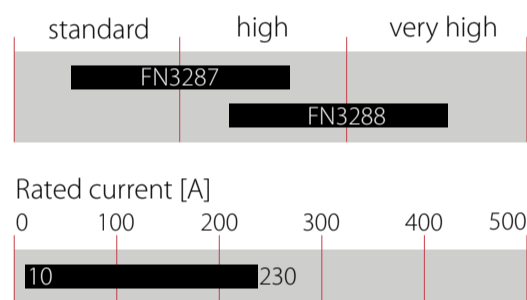

Approvals & Compliances



Features and Benefits

- FN3288 series of filters provides state-of-the-art EMI attenuation based on an innovative filter topology. They help to ensure compliance with Class C2 or even C1 limits.
- Differential mode roll off at low frequency, helping to ensure compliance at 9kHz for all applications, including power drive systems
- The slim book-style shape allows a convenient and space-saving installation next to inverters, converters or motor drives.
- The compact FN3288 filter from 10 to 230A are designed for the most diverse applications worldwide, including machinery and machine tools.
- FN3288HV filters up to 230 A are applicable for 690 VAC distribution networks.
- FN 3288IT and FN 3288HVIT filters up to 230 A meet the special requirements for IT distribution networks.
- Low leakage current filter versions help to fulfill tough requirements (e.g. 0.1 mA) in respect of leakage current limitation.

Technical Specifications

Maximum continuous operating voltage	3x530/305 VAC (FN3288) 3x530 VAC (FN3288IT) 3x760/440 VAC (FN3288HV) 3x760 VAC (FN3288HVIT)
Nominal operating voltage	480 VAC (FN3288, FN3288IT) 690 VAC (FN3288HV, FN3288HVIT)
Rated currents	10 to 230 A 10 to 230 A @ 50°C
Overload capability	6x rated current for 1 sec, once per hour 1.5x rated current for 1 minute, once per hour
Operating frequency	DC to 60 Hz
High potential test voltage	P -> E 2260 VDC for 2 s (FN3288) P -> E 2900 VDC for 2 s (FN3288IT) P -> P 2280 VDC for 2 s (FN3288, FN3288IT) P -> E 2650 VDC for 2 s (FN3288HV) P -> E 3530 VDC for 2 s (FN3288HVIT) P -> P 3270 VDC for 2 s (FN3288HV)
Overvoltage category	III acc. IEC 60664-1
Pollution degree	3 acc. IEC 60664-1
Temperature range (operation and storage)	-40°C to +100°C (with current derating >50°C)
Climatic category	40/100/21 acc. to IEC 60068-1
Protection category	IP 20 acc. to IEC 60529
Flammability corresponding to	UL 94 V-0
Vibration and shock	3M4 (operation) 2M2 (transport) acc. to IEC 60721-3-3 IEC 60721-3-2
Design corresponding to	UL 60939-3, IEC 60939-3
SCCR**	100 kA acc. to UL508 - high fault current
Compliance with insulation requirement	> 1MΩ acc. to IEC 60204-1
MTBF (Mil-HB-217F)	>200,000 h @ 50°C/480 V

Typical Applications





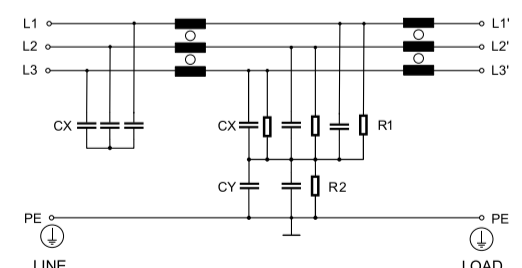



















- Three-phase variable speed drives and power drive systems (PDS)
- Machine tool and machinery equipment
- C1 and C2 class power drive systems, also covering the frequency range below 150kHz to 9kHz
- IT power distribution networks (FN3288IT and FN3288 HVIT)
- General energy conversion devices (inverters, converters)
- Process automation equipment
- Three-phase power supplies
- Low-leakage current requirements

Typical electrical schematic



** SCCR (High Fault Current acc UL508): 100 kA, with overcurrent protection of J-Type current limiting fuses. Fuse rating shall not exceed 150% of filter current rating.

Filter Selection Table

Filter	Buy	Rated current @ 50°C (40°C) [A]	Typical drive Power rating** [kW]	Leakage current*** @ 530 VAC/50 Hz [mA]							Power loss @ 25°C [W]	Terminal Type	Weight [kg]	Frame
				C35	C34	C27	C26	C21	C17	C13				
Capacitor option *C..														
FN3288-10-44-C..-R65		10 (11)	6		5.9		2.5	0.4	0.1		7.1	-44	0.8	A
FN3288-16-44-C..-R65		16 (17)	9	6.0			2.5	0.4	0.1		10.5	-44	1.0	B
FN3288-20-33-C..-R65		20 (22)	12	6.0			2.5	0.4	0.1		10.7	-33	1.2	C
FN3288-25-33-C..-R65		25 (27)	15	6.0			2.5	0.4	0.1		17.8	-33	1.2	C
FN3288-40-33-C..-R65		40 (44)	24	6.0		3.5		0.4	0.1		21.6	-33	1.8	D
FN3288-50-53-C..-R65		50 (55)	29	6.6			2.6	0.4	0.1		32.3	-53	2.5	E
FN3288-63-53-C..-R65		63 (69)	38	6.6			2.6	0.4	0.1		39.3	-53	2.7	E
FN3288-80-34-C..-R65		80 (88)	47	7.1			2.7	0.4	0.1		28.8	-34	4.3	F
FN3288-100-35-C..-R65		100 (110)	59	7.1			2.7	0.4	0.1		36.0	-35	5.1	G
FN3288-125-35-C..-R65		125 (137)	74	7.1			2.7	0.4	0.1		42.2	-35	5.0	G
FN3288-160-40-C..-R65		160 (175)	94	7.1			2.7	0.4	0.1		46.1	-40	6.6	H
FN3288-230-40-C..-R65		230 (230)	135	7.5			2.7	0.4	0.1		47.6	-40	9.3	V
HP for IT power networks****:														
FN3288IT-10-44-C..-R60		10 (11)	6		5.9						6.2	-44	1.1	I
FN3288IT-16-44-C..-R60		16 (17)	9		5.9						9.7	-44	1.3	J
FN3288IT-20-33-C..-R60		20 (22)	12		5.9						13.2	-33	1.6	K
FN3288IT-25-33-C..-R60		25 (27)	15		5.9						15.6	-33	1.6	K
FN3288IT-40-33-C..-R60		40 (44)	24		5.9						18.7	-33	2.8	L
FN3288IT-50-53-C..-R60		50 (55)	29		6.5						27.0	-53	2.8	M
FN3288IT-63-53-C..-R60		63 (69)	37		6.5						34.5	-53	2.9	M
FN3288IT-80-34-C..-R60		80 (88)	47		7.0						28.8	-34	4.6	N
FN3288IT-100-35-C..-R60		100 (110)	59		7.0						33.0	-35	5.4	O
FN3288IT-125-35-C..-R60		125 (137)	74		7.0						42.2	-35	5.3	O
FN3288IT-160-40-C..-R60		160 (175)	94		7.0						46.1	-40	6.9	P
FN3288IT-230-40-C..-R60		230 (230)	135		7.0					0.02	47.6	-40	9.3	V

* Replace C.. with corresponding listed C35, C34, C27, C26, C21, C17 or C13.

** Typical power rating at 400 VAC for FN3288 with $\cos \phi = 0.85$. The exact value depends upon the efficiency of the drive, the motor and the entire application.

*** Standardized calculated leakage current acc. IEC 60939 under normal operating conditions (FN3288 and FN3288 IT at 530 VAC).

**** These filters may be operated in IT system as long as the operation conditions and possible short circuit/fault (earth connection of one conductor) occurs between the supply (line side) and the filter. The filters are not designed for short circuit/faults occurring between converter and motor.

Filter Selection Table

Filter	Buy	Rated current @ 50°C (40°C) [A]	Typical drive Power rating** [kW]	Leakage current*** @ 760 VAC/50 Hz [mA]								Power loss @ 25°C [W]	Terminal Type	Weight [kg]	Frame	
				C44	C43	C42	C36	C34	C26	C25	C24					C17
Capacitor option * C..																
High voltage versions:																
FN3288HV-10-44-C..-R65		10 (11)	10					8.4				1.8	7.0	-44	1.2	I
FN3288HV-16-44-C..-R65		16 (17)	16					8.4		2.5			10.8	-44	1.5	J
FN3288HV-20-33-C..-R65		20 (22)	20				10.9			2.5			12.6	-33	1.8	K
FN3288HV-25-33-C..-R65		25 (27)	25				10.9			2.5			14.6	-33	1.9	K
FN3288HV-40-33-C..-R65		40 (44)	41				12.4			2.6			19.2	-33	2.9	L
FN3288HV-50-53-C..-R65		50 (55)	51				12.4			2.6			29.3	-53	3.3	M
FN3288HV-63-53-C..-R65		63 (69)	64				12.4			2.6			38.1	-53	3.5	M
FN3288HV-80-34-C..-R65		80 (88)	81				12.4			2.6			28.8	-34	4.9	N
FN3288HV-100-35-C..-R65		100 (110)	101				12.4			2.6			33.0	-35	5.8	O
FN3288HV-125-35-C..-R65		125 (137)	127				12.4			2.6			42.0	-35	5.9	O
FN3288HV-160-40-C..-R65		160 (175)	162				12.4			2.6			46.1	-40	7.2	P
FN3288HV-230-40-C..-R65		230 (230)	233				12.4			2.6		0.1	47.6	-40	9.3	V
HV for IT power networks****:																
FN3288HVIT-10-44-C..-R60		10 (11)	10			4.6				3.6			7.0	-44	1.2	I
FN3288HVIT-16-44-C..-R60		16 (17)	16			6.8				3.7			10.8	-44	1.5	J
FN3288HVIT-20-33-C..-R60		20 (22)	20			6.8				3.7			12.6	-33	1.8	K
FN3288HVIT-25-33-C..-R60		25 (27)	25			6.8				3.7			14.6	-33	1.9	K
FN3288HVIT-40-33-C..-R60		40 (44)	41			6.8				3.7			19.2	-33	2.9	L
FN3288HVIT-50-53-C..-R60		50 (55)	51			6.8				3.7			29.3	-53	3.3	M
FN3288HVIT-63-53-C..-R60		63 (69)	64			6.8				3.7			38.1	-53	3.5	M
FN3288HVIT-80-34-C..-R60		80 (88)	81			6.8				3.7			28.8	-34	4.9	N
FN3288HVIT-100-35-C..-R60		100 (110)	101			6.8				3.7			33.0	-35	5.8	O
FN3288HVIT-125-35-C..-R60		125 (137)	127	5.9						3.7			42.2	-35	5.9	O
FN3288HVIT-160-40-C..-R60		160 (175)	162			6.8				3.7			46.1	-40	7.2	P
FN3288HVIT-230-40-C..-R60		230 (230)	233					12.4		3.7			47.1	-40	9.3	V

* Replace C.. with corresponding listed C44, C43, C42, C36, C34, C26, C25, C24 or C17.

** Typical power rating (400 VAC for FN3288 / 690 VAC for FN3288 HV and FN3288 HVIT) with cos phi=0.85. The exact value depends upon the efficiency of the drive, the motor and the entire application.

*** Standardized calculated leakage current acc. IEC 60939 under normal operating conditions (FN3288 HV and FN3288 HVIT at 760 VAC).

**** These filters may be operated in IT system as long as the operation conditions and possible short circuit/fault (earth connection of one conductor) occurs between the supply (line side) and the filter. The filters are not designed for short circuit/faults occurring between converter and motor.

Distribution Inventory

Up-to-date inventory levels for global distributors is available at

<https://products.schaffner.com/stock>



Typical Filter Attenuation – FN3288 Low Leakage Current Version

Per CISPR 17: symmetrical 50 Ω /50 Ω -> Differential Mode (DM); asymmetrical 50 Ω /50 Ω -> Common Mode (CM)

FN3288-10-44-C21-R65

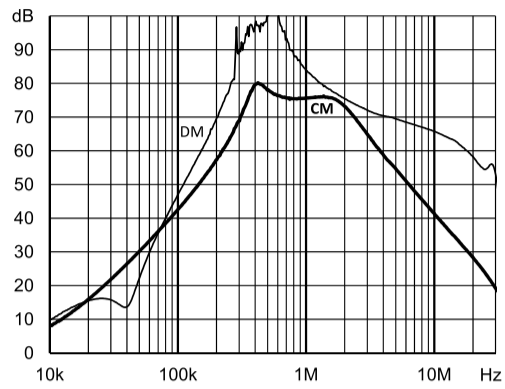

FN3288-16-44-C21-R65

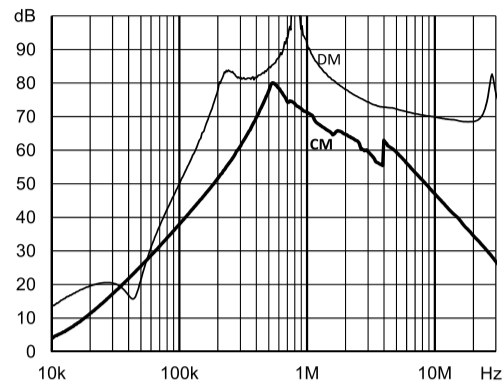

FN3288-20-33-C21-R65

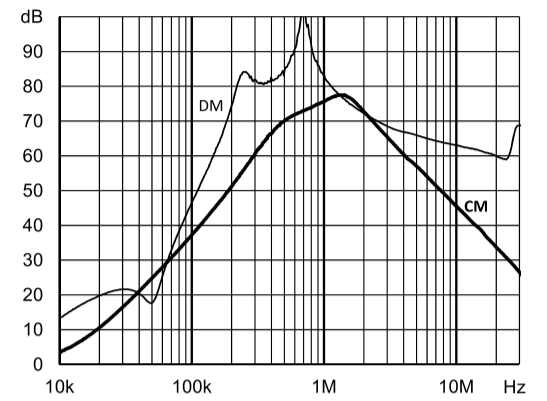

FN3288-25-33-C21-R65

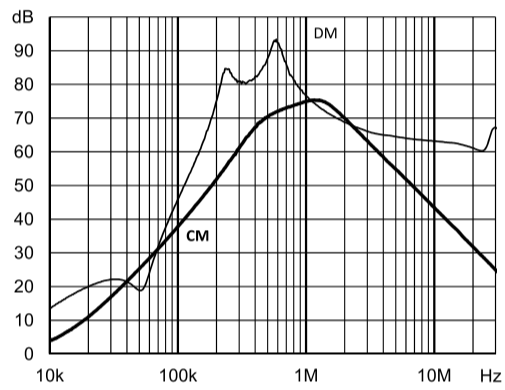

FN3288-40-33-C21-R65

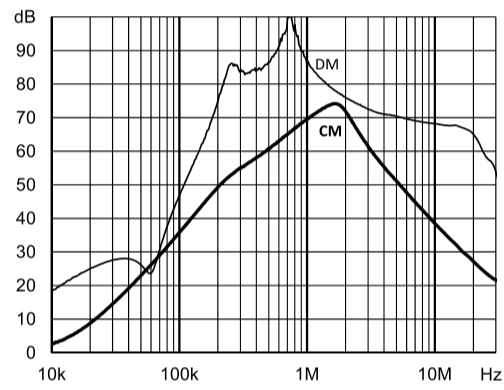

FN3288-50-53-C21-R65

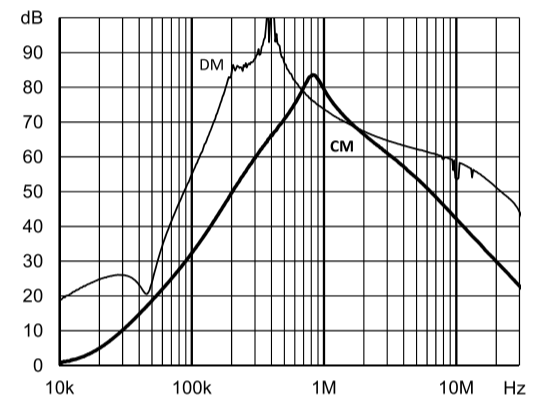

FN3288-63-53-C21-R65

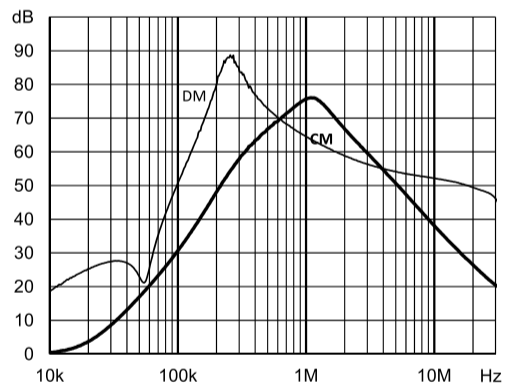

FN3288-80-34-C21-R65

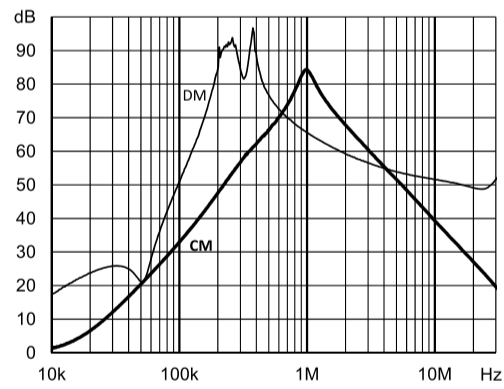

FN3288-100-35-C21-R65

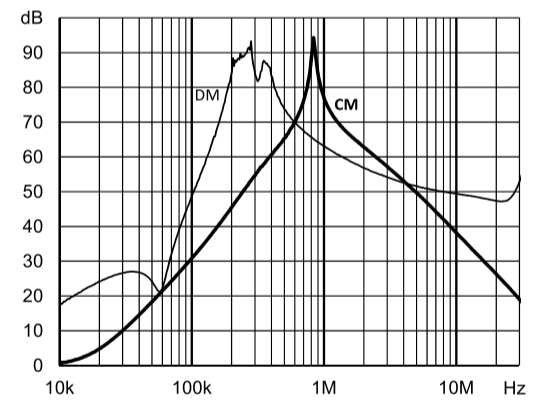

FN3288-125-35-C21-R65

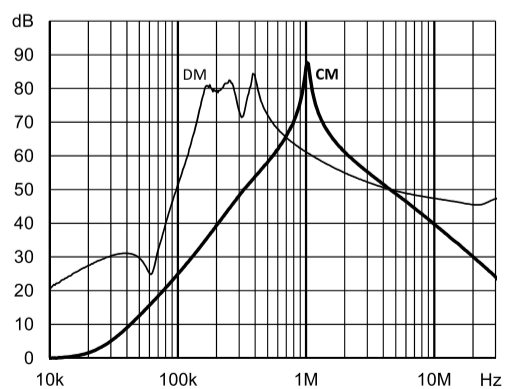

FN3288-160-40-C21-R65

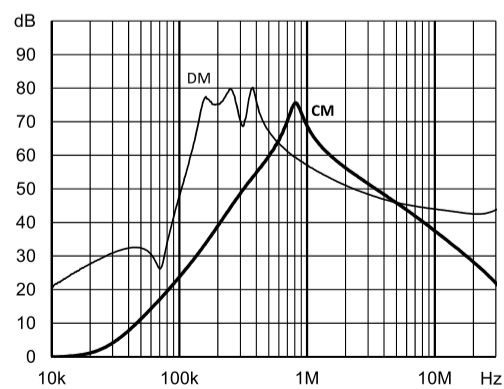

FN3288-230-40-C17-R65

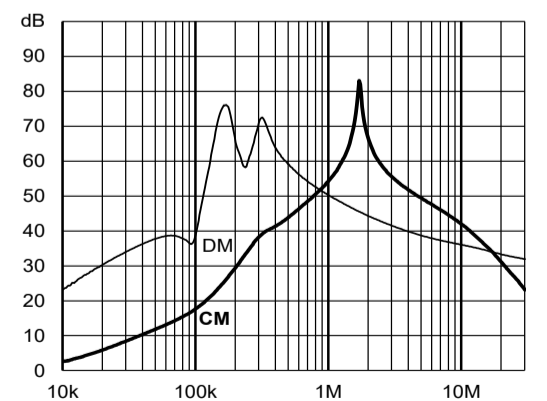

Mechanical Data

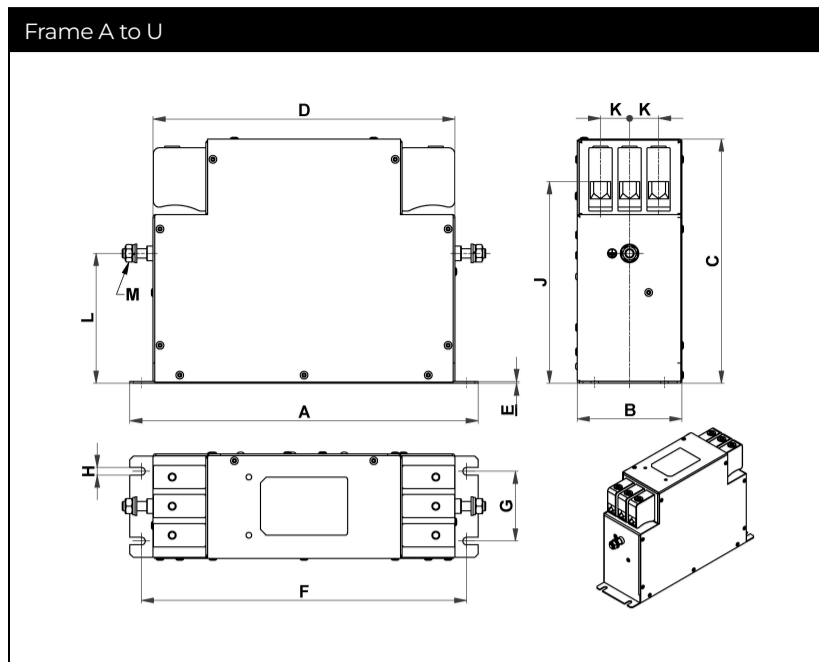

Dimensions*

Frame	A	B	C	D	E	F	G	H	J+/-2	K	L+/-1	M**
A	185	40	120	157	0.8	175	20	4.5	102	11	76	M5
B	195	45	140	164	0.8	180	25	5.4	122	11	93	M5
C	210	45	145	174	0.8	195	25	5.4	126	13	96	M5
D	235	50	168	207	1.0	220	30	5.4	149	13	115	M6
E	255	65	180	226	1.0	240	45	5.4	156	16	120	M6
F	290	80	205	250	1.2	270	50	6.5	172	22	110	M6
G	300	90	210	260	1.5	280	60	6.5	173	25	112	M8
H	310	100	225	270	1.5	290	70	6.5	183	28	110	M10
I	230	50	132	203	0.8	220	30	4.5	114	12.5	88	M5
J	230	55	159	198	0.8	215	35	5.4	141	13	112	M5
K	245	55	167	212	0.8	230	35	5.4	148	13	118	M5
L	265	60	191	237	1.0	250	40	5.4	172	13	135	M6
M	265	70	194	237	1.0	250	50	5.4	170	16	133	M6
N	310	95	220	270	1.2	290	65	6.5	187	22	125	M6
O	320	95	230	280	1.5	300	65	6.5	192	25	127	M8
P	330	100	240	290	1.5	310	70	6.5	198	30	127	M10
Q	180	40	112	153	0.8	170	20	4.5	94	11	68	M5
R	200	45	120	170	0.8	185	25	5.4	102	11	76	M5
S	205	45	132	173	0.8	190	25	5.4	113	13	83	M5
T	215	50	147	185	1.0	200	30	5.4	128	13	95	M6
U	220	65	180	186	1.0	205	45	5.4	156	16	120	M6
V	350	105	240	310	1.5	330	70	6.5	190	30.5	125	M10

* All dimensions in mm. For dimensions without stated tolerances: ISO 2768-m/EN 22768-m

** Earth screw torque: M5 2.0-2.2 Nm; M6 3.5-4.0 Nm; M8 8.0-9.0 Nm; M10 15-17 Nm

Filter Input/Output Connector Cross Sections

	-44	-33	-53	-34	-35	-40
Solid wire	0.5-10 mm ²	0.5-16 mm ²	0.5-16 mm ²	6-35 mm ²	10-50 mm ²	25-95 mm ²
Flex wire	0.5-6 mm ²	0.5-10 mm ²	0.5-16 mm ²	6-25 mm ²	16-50 mm ²	25-95 mm ²
Flex wire AWG	AWG 20-8	AWG 22-6	AWG 20-4	AWG 6-2	AWG 6-1/0	AWG 0-4/0
Recommended torque	1.0-1.2 Nm	1.5-1.8 Nm	2.0-2.3 Nm	4.0-4.5 Nm	7.0-8.0 Nm	17-20 Nm

Please visit www.schaffner.com to find more details on filter connectors.

We are here to help



Read more insights from TE's experts:

Connect With Us

We make it easier to connect with our experts and are ready to provide the support you need. Visit te.com/support to chat with a Product Information Specialist.

te.com

©2025 TE Connectivity plc. All Rights Reserved.

TE Connectivity, TE, TE connectivity (logo), and EVERY CONNECTION COUNTS, ECOSine, Schaffner are trademarks owned or licensed by TE Connectivity plc. family of companies. All other logos, products and/or company names referred to herein might be trademarks of their respective owners.

While TE has made every reasonable effort to ensure the accuracy of the information in this document, TE does not guarantee that it is error-free, nor does TE make any other representation, warranty or guarantee that the information is accurate, correct, reliable or current. TE reserves the right to make any changes to the information contained herein without prior notice. TE Connectivity assumes only those obligations set forth in the terms and conditions for this product and shall in no event be liable for any incidental, indirect, or consequential damages arising out of the sale, resale, use, or misapplication of the product. TE expressly disclaims any implied warranties with respect to the information contained herein, including, but not limited to, implied warranties of merchantability or fitness for a particular purpose. Dimensions, specifications and/or information contained herein are for reference purposes only and are subject to change without notice. Consult TE for the latest dimensions, specifications and/or information. Users of TE Connectivity products must make their own assessment as to whether the respective product is suitable for the respective desired application.

ED 01/25

schaffner
MORE POWER TO YOU

is now part of

TE
connectivity