

Overview

KO-CAP Polymer Capacitors

The KEMET Organic Capacitor (KO-CAP) is a solid electrolytic capacitor with a conductive polymer cathode capable of delivering very low ESR and improved capacitance retention at high frequencies. KO-CAP combines the low ESR of multilayer ceramic, the high capacitance of aluminum electrolytic, and the volumetric efficiency of tantalum into a single surface mount package. Unlike liquid electrolyte-based capacitors, KO-CAP has a very long operational life and high ripple current capabilities.

The T52X/T530 provides the widest range of voltages, capacitance and case size options in the KO-CAP family and is suitable for general purpose DC applications for up to 48 VDC voltage rails.

Benefits

- ESR values down to 4 mΩ
- Stable capacitance across temperature and voltage
- No aging effects
- High ripple handling
- Volumetrically efficient
- High frequency capacitance retention
- 100% accelerated steady state aging
- 100% surge current tested

Applications

Typical applications include DC/DC converters, audio/sound circuits (mobile phone and base stations, smart phones, MP3 players), power supply inputs, portable electronics (notebook PCs, displays, SSDs, HDDs and USBs, digital cameras, GPS navigation systems, WiFi modules), telecommunications, consumer electronics (analytical and test equipment, high speed servers), high voltage applications such as 12 V to 48 V power input rails, densely populated circuits with space restrictions, microprocessor decoupling, and high ripple current applications.

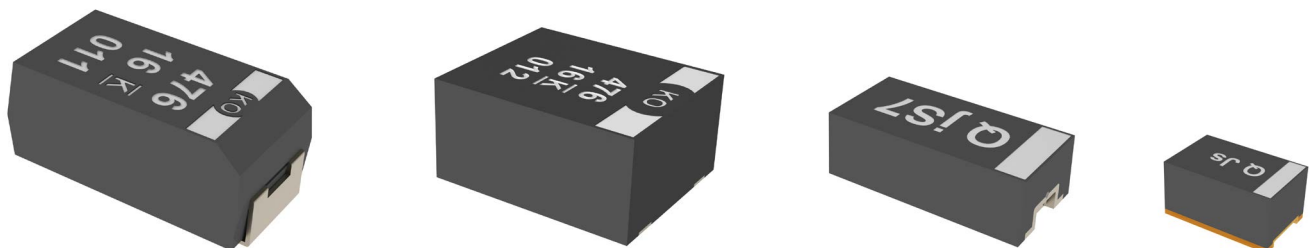

Environmental Compliance

- RoHS compliant when ordered with 100% Sn, Ni-Pd-Au or non-magnetic 100% Sn solder
- Halogen-free
- Epoxy compliant with UL94 V-0*¹

*¹: Except part numbers in the T529 series, please refer to the Table 1

K-SIM

For a detailed analysis of specific part numbers, please visit <https://ksim.kemet.com/capacitor-simulation> to access KEMET's K-SIM software. KEMET K-SIM is designed to simulate behavior of components with respect to frequency, ambient temperature, and DC bias levels.

Series Reference Selection

| Series | | Voltage Range | | Maximum Operating Temperature | | | Special Features | | |
|--------|--------------------|---------------------------|---------------------------|-------------------------------|-------------|-------------|------------------|---------|----------------|
| | | < 1 V to 9 V Applications | 12 V to 48 V Applications | 85°C Rated | 105°C Rated | 125°C Rated | Miniature Size | Low ESL | Low DC Leakage |
| T520 | Standard | X | * | X** | X | | | | |
| T521 | High Voltage | | X | | X | X | | | X |
| T523 | Facedown Terminal | X | X** | X | X** | | | X | |
| T525 | High Temperature | X | * | | | X | | | |
| T527 | Small Size | X | X | | X | | X | | |
| T529 | Miniature | X | X | | X | | X | | |
| T530 | High Cap/ Low ESR | X | X | | | X | | | |
| TF08 | Ultrathin-Facedown | X | | | X | | X | | |

* Not recommended for new design.

** Selected values.

T52X/T530 Polymer Electrolytic Capacitors

KEMET Organic Capacitor (KO-CAP®)

Ordering Information

T52X/T530

| T | 520 | V | 157 | M | 006 | A | T | E045 | |
|-----------------|--|---|---|-----------------------|--|---------------------|---|---|--|
| Capacitor Class | Series | Case Size ¹ | Capacitance Code (pF) | Capacitance Tolerance | Rated Voltage (VDC) | Failure Rate/Design | Termination Finish | ESR & DC Leakage Code | Packaging (C-Spec) |
| T = Tantalum | 520 = Polymer 521 = High voltage 523 = Facedown terminal 525 = 125°C rated 527 = Facedown terminal 529 = Substrate terminal 530 = 125°C High capacitance | A B C D H I J K L M P Q S T U V W X Y | First two digits represent significant figures. Third digit specifies number of zeros. | K = ±10% M = ±20% | 002 = 2 2R5 = 2.5 003 = 3 004 = 4 006 = 6.3 008 = 8 010 = 10 011 = 11 12R = 12.5 016 = 16 018 = 18 020 = 20 025 = 25 035 = 35 050 = 50 063 = 63 075 = 75 | A = N/A | T = 100% Matte tin (Sn)-plated H*** = Tin/lead (SnPb) solder coated (5% Pb minimum) P* = Ni-Pd-Au-plated A** = Ni-Au | E = ESR last three digits specify ESR in mΩ. (045 = 45 mΩ). DC Leakage max 0.1 CV K = ESR last three digits specify ESR in mΩ. DC Leakage max 0.05 CV I = ESR last three digits specify ESR in mΩ. DC Leakage max 0.03 CV | Blank = 7" reel 7280**** = 13" reel |

Gold termination available upon request

Non-magnetic terminations available for customized solutions. For availability and technical information, please contact your KEMET sales representative.

Letter "N" in the FR position for parts identified with ^ in the part number table denotes 2000 hrs of Endurance time

* P termination only available on select part numbers

** A termination only available on T529 part numbers

*** H termination not available for T527/T529 part numbers

**** 13" reel not available for T520A case and some other part numbers

Ordering Information cont.

TF08

| T | F | 08A | 226 | M | 016 | A | P | E200 |
|-----------------|---|---------------------------|--|-----------------------|-----------------------|----------------------|---------------------|---|
| Capacitor Class | Series | Case Size | Capacitance Code (pF) | Capacitance Tolerance | Rated Voltage (VDC) | Failure Rate/ Design | Termination Finish | ESR Code |
| T = Tantalum | F= Ultrathin polymer solution-Facedown construction | 08A = 3216/0.8 max height | First two digits represent significant figures. Third digit specifies number of zeros. | M = ±20% | 006 = 6.3 016 = 16 | A = N/A | P = Ni-Pd-Au-plated | E = ESR Last three digits specify ESR in mΩ (200 = 200mΩ) |

Performance Characteristics

| Item | Performance Characteristics |
|-------------------------|---|
| Operating Temperature | -55°C to 85°C/105°C/125°C (refer to part number for maximum temperature rating) |
| Rated Capacitance Range | 0.68 – 1,500 µF at 120 Hz/25°C * |
| Capacitance Tolerance | K tolerance (10%), M tolerance (20%) |
| Rated Voltage Range | 2 – 75 V |
| DF (120 Hz) | Refer to Part Number Electrical Specification Table* |
| ESR (100 kHz) | Refer to Part Number Electrical Specification Table** |
| Leakage Current | Refer to Part Number Electrical Specification Table |

* For parts identified with ^ symbol in the part numbers table, apply 1.5 V DC for measurement

** For PN T520B477M2R5ATE014 the ESR measurement should be taken at 300 to 500kHz

Qualification

| Test | Condition | Characteristics | |
|--------------|---|-----------------|--|
| Endurance | Temperature: 85°C, 105°C ^{*2} Voltage: 1.0 Rated Voltage Time: 2,000 Hours | Δ C/C | Within -20%/+10% of initial value or ±20 ^{*1} |
| | | DF | Within initial limits or 1.5 x initial limit ^{*1} |
| | | DCL | Within initial limit ^{*1} Within 1.25 x initial limit Within 1.5 x initial limit (for TF08A) |
| | | ESR | Within 2.0 x initial limit or N/A ^{*1} |
| Endurance | Temperature: 125°C ^{*2} Voltage: 2/3 rated voltage 0.8 rated voltage (for parts with derate category 7 and 8) Time: 2,000 hours | Δ C/C | Within -20/+10 of initial value |
| | | DF | Within initial limit |
| | | DCL | Within 2.0 x initial limit |
| | | ESR | Within 2.0 x initial limit |
| Storage Life | Temperature: 105°C, 125°C ^{*2} Voltage: 0 Voltage Time: 2,000 Hours (This test is N/A for ^{*1}) | Δ C/C | Within -20%/+10% of initial value |
| | | DF | Within initial limits |
| | | DCL | Within 1.25 x initial limit T521: 1.25 x IL at 105°C, 2x IL at 125°C T525/T530: Within 2.0 x initial limit |
| | | ESR | Within 2.0 x initial limit |

^{*1} For case code 3528-21 and lower identified with ^ at the part number table (except the T520A, T527T226M025ATE100, T520B337M2R5ATE009, T520B337M2R5NTE009) and for T521 parts rated 105°C

^{*2} Please refer to part number specifications for individual temperature classification.

^{*3} IL = Initial limit

^{*4} For T527/T529 > 20 V test temperature is at + 15 to +35°C, test voltage at 1.16 x V_r (except T527T226M025ATE100 test temperature is +105°C)

For T527/T529/TF, 6 V test voltage is 1.27 x rated voltage

For TFA08226M016 and T521V336M035AT test voltage is 1.15 x rated voltage

^{*5} +85°C measurement is applicable to: T527T226M025ATE100

^{*6} Delta cap condition of +50/ 0% is applicable to: T527T226M025APE100

^{*7} DF at 1.5 X IL is applicable to: T527T226M025APE100

Qualification cont.

| | | | | | | |
|----------------------------|--|-------|--|--|--|--|
| Humidity | Temperature: 60°C Voltage: No Load Humidity: 90% RH Time: 500 Hours, 1,000 Hours (T525, T530) | Δ C/C | Within -5%/+35% of initial value or -20%, +30% of initial DC/C limit* ¹ T520B477M2R5ATE014: -20% to +50% of initial DC/C limit | | | |
| | | DF | Within initial limits T527/T529/TF08A: Within 1.5 x initial limits* ³ | | | |
| | | DCL | Within 5.0 x initial limit T521/T525/T529/T530: Within 3.0 x initial limit* ³ T527/TF08A: Within initial limits | | | |
| | | ESR | Within 2.0 x initial limit T525/T527/T529/T530/TF08A: N/A* ³ | | | |
| Temperature Stability | Extreme temperature exposure at a succession of continuous steps at +25°C, -55°C, +25°C, +85°C, +105°/125°C* ² , +25°C | +25°C | -55°C | +85°C (N/A T527/T529/ TF08A)* ⁵ | +105°C | |
| | | Δ C/C | IL* ³ | ±20% 0% to -20% of DC/C* ¹ | ±20% +50% to 0% of DC/C* ⁶ | ±30% +50% to 0% of DC/C* ^{1,6} |
| | | DF | IL | IL | 1.2 x IL 1.5 x IL* ⁷ | 1.5 x IL |
| | | DCL | IL | N/A | 10 x IL | 10 x IL |
| Surge Voltage | Temperature: 105°C, 85°C* ^{1,2,4} Voltage: 1.32 x Rated voltage* ⁴ 1.0 x Rated voltage* ¹ Time: 1,000 cycles | Δ C/C | Within -20%/+10% of initial value or ±20%* ¹ | | | |
| | | DF | Within initial limits | | | |
| | | DCL | Within initial limits | | | |
| | | ESR | Within initial limits or N/A* ¹ | | | |
| Mechanical Shock/Vibration | MIL-STD-202, Method 213, Condition I, 100 G Peak. MIL-STD-202, Method 204, Condition D, 10 Hz to 2,000 Hz, 20 G peak | Δ C/C | Within ±10% of initial value or initial DC/C limits* ¹ | | | |
| | | DF | Within initial limits | | | |
| | | DCL | Within initial limits | | | |

*¹ For case code 3528-21 and lower identified with ^ at the part number table (except the T520A, T527T226M025ATE100)

*² Please refer to part number specifications for individual temperature classification.

*³ IL = Initial limit

*⁴ For T527/T529 > 20 V test temperature is at + 15 to +35°C, test voltage at 1.16 x V_R (except T527T226M025ATE100 test temperature is +105°C)

For T527/T529/TF, 6 V test voltage is 1.27 x rated voltage

For TFA08226M016, T521V476M035AT and T521V336M035AT test voltage is 1.15 x rated voltage

*⁵ +85°C measurement is applicable to: T527T226M025ATE100

*⁶ Delta cap condition of +50/ 0% is applicable to: T527T226M025APE100

*⁷ DF at 1.5 X IL is applicable to: T527T226M025APE100

Reliability

KO-CAP capacitors have an average failure rate of 0.5 %/1,000 hours at category voltage, U_C , and category temperature, T_C . These capacitors are qualified using industry test standards at U_C and T_C . The minimum test time (1,000 hours or 2,000 hours) is dependent on the product.

The actual life expectancy of KO-CAP capacitors increases when application voltage, U_A , and application temperature, T_A , are lower than U_C and T_C . As a general guideline, when $U_A < 0.9 * U_C$ and $T_A < 85^\circ\text{C}$, the life expectancy will typically exceed the useful lifetime of most hardware (> 10 years).

The lifetime of a KO-CAP capacitor at a specific application voltage and temperature can be modeled using the equations below. A failure is defined as passing enough current to blow a 1-amp fuse. The calculation is an estimation based on empirical results and is not a guarantee.

$$VAF = \left(\frac{U_C}{U_A}\right)^n$$

where:
 VAF = acceleration factor due to voltage, unitless
 U_C = category voltage, volt
 U_A = application voltage, volt
 n = exponent, 16

$$TAF = e^{\left[\frac{E_a}{k} \left(\frac{1}{273+T_A} - \frac{1}{273+T_C}\right)\right]}$$

where:
 TAF = acceleration factor due to temperature, unitless
 E_a = activation energy, 1.4 eV
 k = Boltzmann's constant, 8.617E-5 eV/K
 T_A = application temperature, °C
 T_C = category temperature, °C

$$AF = VAF * TAF$$

where:
 AF = acceleration factor, unitless
 TAF = acceleration factor due to temperature, unitless
 VAF = acceleration factor due to voltage, unitless

$$Life_{U_A, T_A} = Life_{U_C, T_C} * AF$$

where:
 $Life_{U_A, T_A}$ = estimated life application voltage and temperature, years
 $Life_{U_C, T_C}$ = guaranteed life category voltage and temperature, years
 AF = acceleration factor, unitless

Terms:

Category voltage, U_C : maximum recommended peak DC operating voltage for continuous operation at the category temperature, T_C

Rated voltage, U_R : maximum recommended peak DC operating voltage for continuous operation up to the rated temperature, T_R

Category temperature, T_C : maximum recommended operating temperature. Voltage derating may be required at T_C

Rated temperature, T_R : maximum recommended operating temperature without voltage derating. T_R is equal to or lower than T_C

| Reliability Table 1 – Common temperature range classifications | | | | | | | | | | | | | | |
|--|----------------------------|-----|-----|-----|-----|------|------|------|------|------|------|------|------|------|
| 85°C (T_R) / 85°C (T_C) | Rated Voltage (U_R) | 2.5 | 4.0 | 6.3 | 8.0 | 10.0 | 12.5 | 16.0 | 20.0 | 25.0 | 35.0 | 50.0 | 63.0 | 75.0 |
| | Category Voltage (U_C) | 2.5 | 4.0 | 6.3 | 8.0 | 10.0 | 12.5 | 16.0 | 20.0 | 25.0 | 35.0 | 50.0 | 63.0 | 75.0 |
| 105°C (T_R) / 105°C (T_C) | Rated Voltage (U_R) | 2.5 | 4.0 | 6.3 | 8.0 | 10.0 | 12.5 | 16.0 | 20.0 | 25.0 | 35.0 | 50.0 | 63.0 | 75.0 |
| | Category Voltage (U_C) | 2.5 | 4.0 | 6.3 | 8.0 | 10.0 | 12.5 | 16.0 | 20.0 | 25.0 | 35.0 | 50.0 | 63.0 | 75.0 |
| 105°C (T_R) / 125°C (T_C) | Rated Voltage (U_R) | 2.5 | 4.0 | 6.3 | 8.0 | 10.0 | 12.5 | 16.0 | 20.0 | 25.0 | 35.0 | 50.0 | 63.0 | 75.0 |
| | Category Voltage (U_C) | 1.7 | 2.7 | 4.2 | 5.4 | 6.7 | 8.4 | 10.7 | 13.4 | 16.8 | 23.5 | 33.5 | 42.2 | 50.3 |

Electrical Characteristics

T520 Standard (2 V – 10 V)

ESR vs. Frequency

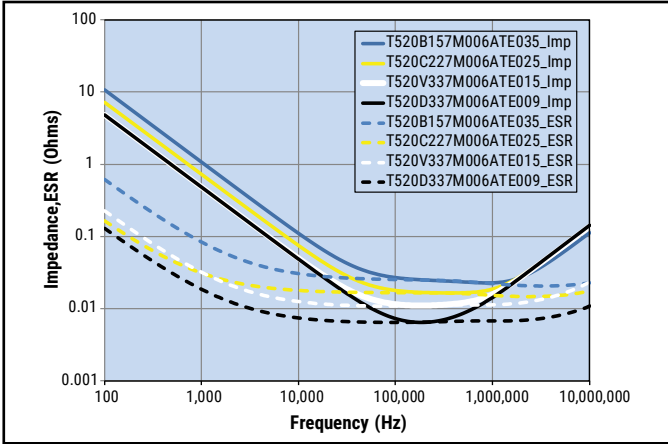

Capacitance vs. Frequency

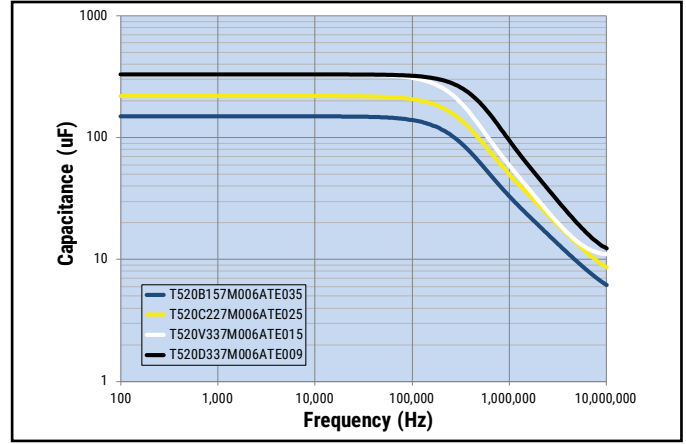

T521 High Voltage (12 V – 75 V)

ESR vs. Frequency

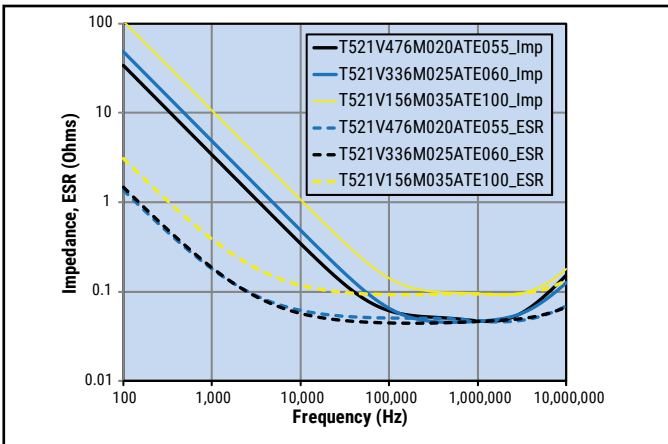

Capacitance vs. Frequency

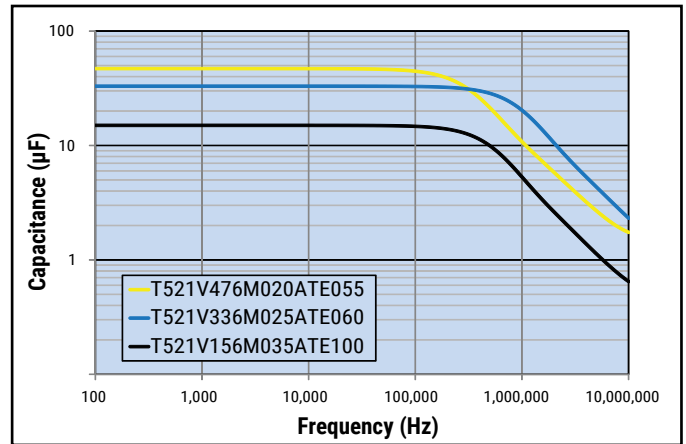

T530 High Cap/Low ESR (2 V – 10 V)

ESR vs. Frequency

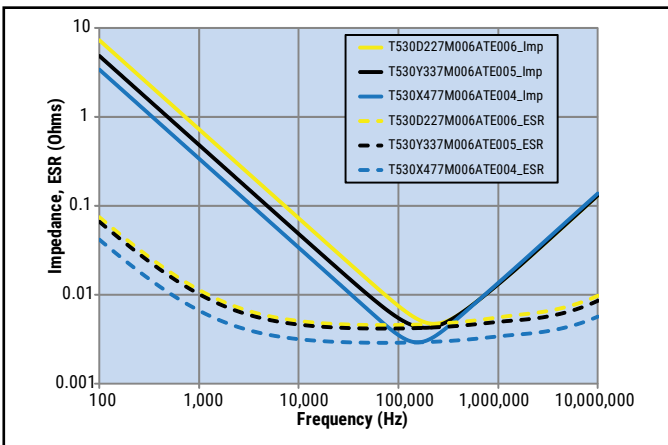

Capacitance vs. Frequency

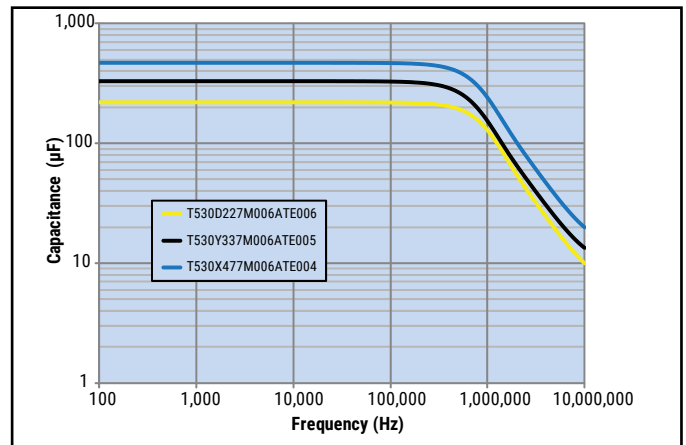

T52X/T530 Polymer Electrolytic Capacitors

KEMET Organic Capacitor (KO-CAP®)

Dimensions – Millimeters (Inches)

Metric will govern

T520 / T521 / T525 / T530

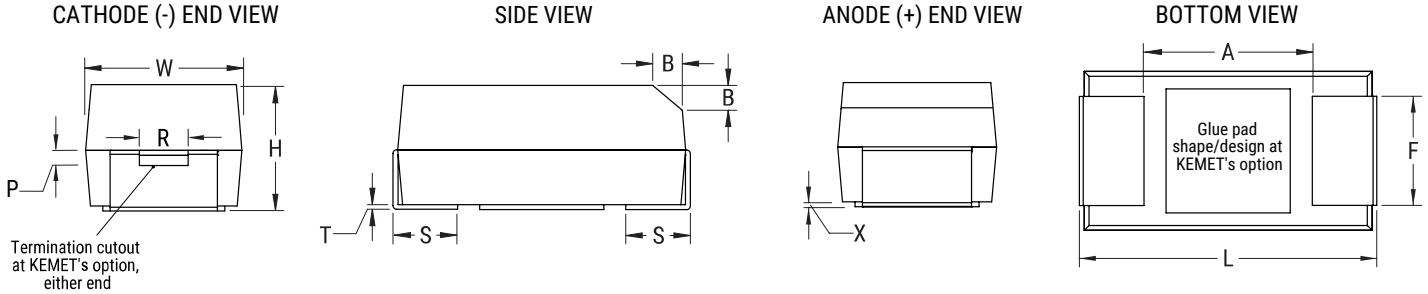

| Case Size | | Component Dimensions | | | | | | | | | | | Typical Weight (mg) |
|-----------|---------|----------------------------|----------------------------|--|---|--|-------------------------|------------------------------|----------------|----------------|-----------------|----------------|---------------------|
| KEMET | EIA | L | W | H | F | S ±0.3 ±(0.012) S1 ±0.4 (0.0157) S2 ±0.2 (0.00) | B ±0.15 (Ref) ±0.006 | X (Ref) | P (Ref) | R (Ref) | T (Ref) | A (Min) | |
| A | 3216-18 | 3.2 ±0.2 (0.126 ±0.008) | 1.6 ±0.2 (0.063 ±0.008) | 1.6 ±0.2 (0.063 ±0.008) | 1.2 (0.047) | 0.8 (0.032) | N/A | 0.10 ±0.10 (0.004 ±0.004) | 0.4 (0.016) | 0.4 (0.016) | 0.13 (0.005) | 1.2 (0.047) | 53 |
| B | 3528-20 | 3.5 ±0.2 (0.138 ±0.008) | 2.8 ±0.2 (0.110 ±0.008) | 1.9 ±0.1 ^{*3} (0.075 ±0.004) | 2.2 (0.087) | 0.8 (0.032) S1 = 0.8 (0.032) ^{*2} S2 = 0.8 (0.032) ^{*2} | 0.4 (0.016) | 0.10 ±0.10 (0.004 ±0.004) | 0.5 (0.020) | 1.0 (0.039) | 0.13 (0.005) | 1.9 (0.075) | 95 |
| C | 6032-28 | 6.0 ±0.3 (0.236 ±0.012) | 3.2 ±0.2 (0.126 ±0.008) | 2.5 ±0.3 (0.098 ±0.012) | 2.2 (0.087) | 1.30 (0.051) | 0.5 (0.020) | 0.10 ±0.10 (0.004 ±0.004) | 0.9 (0.035) | 1.0 (0.039) | 0.13 (0.005) | 2.9 (0.114) | 184 |
| D | 7343-31 | 7.3 ±0.3 (0.287 ±0.012) | 4.3 ±0.3 (0.169 ±0.012) | 2.8 ±0.3 (0.110 ±0.012) | 2.4 (0.094) | 1.30 (0.051) | 0.5 (0.020) | 0.10 ±0.10 (0.004 ±0.004) | 0.9 (0.035) | 1.0 (0.039) | 0.13 (0.005) | 3.8 (0.150) | 435 |
| H | 7360-20 | 7.3 ±0.3 (0.287 ±0.012) | 6.0 ±0.3 (0.236 ±0.012) | 1.9 ±0.1 (0.075 ±0.004) | 4.1 (0.161) | 1.3 (0.051) | N/A | 0.10 ±0.10 (0.004 ±0.004) | N/A | N/A | 0.13 (0.005) | 3.3 (0.130) | 385 |
| J | 7360-15 | 7.3 ±0.3 (0.287 ±0.012) | 6.0 ±0.3 (0.236 ±0.012) | 1.5 (0.059) Maximum | 4.1 (0.161) | 1.3 (0.051) | N/A | 0.10 ±0.10 (0.004 ±0.004) | N/A | N/A | N/A | 3.3 (0.130) | 263 |
| L | 6032-19 | 6.0 ±0.3 (0.236 ±0.012) | 3.2 ±0.2 (0.126 ±0.008) | 1.8 ±0.1 (0.071 ±0.004) | 2.2 (0.087) | 1.3 (0.051) | N/A | 0.05 (0.002) | N/A | N/A | 0.13 (0.005) | 2.5 (0.098) | 187 |
| M | 3528-15 | 3.5 ±0.2 (0.138 ±0.008) | 2.8 ±0.2 (0.110 ±0.008) | 1.4 ±0.1 (0.055 ±0.004) | 2.2 (0.087) | 0.8 (0.031) | N/A | 0.05 (0.002) | N/A | N/A | 0.13 (0.005) | 1.1 (0.043) | 98 |
| Q | 7343-12 | 7.3 ±0.3 (0.287 ±0.012) | 4.3 ±0.3 (0.169 ±0.012) | 1.1 ±0.1 (0.043 ±0.004) | 2.4 (0.094) | 1.3 (0.051) | N/A | 0.05 (0.002) | N/A | N/A | 0.13 (0.005) | 3.8 (0.150) | 170 |
| T | 3528-12 | 3.5 ±0.2 (0.138 ±0.008) | 2.8 ±0.2 (0.110 ±0.008) | 1.1 ±0.1 (0.043 ±0.004) | 2.2 (0.087) | 0.8 (0.031) | N/A | 0.05 (0.002) | N/A | N/A | 0.13 (0.005) | 1.9 (0.075) | 55 |
| U | 6032-15 | 6.0 ±0.3 (0.236 ±0.012) | 3.2 ±0.2 (0.126 ±0.008) | 1.4 ±0.1 (0.055 ±0.004) | 2.2 (0.087) | 1.3 (0.051) | N/A | 0.05 (0.002) | N/A | N/A | 0.13 (0.005) | 2.9 (0.114) | 117 |
| V | 7343-19 | 7.3 ±0.3 (0.287 ±0.012) | 4.3 ±0.3 (0.169 ±0.012) | 1.8 ±0.1 ^{*1} (0.071 ±0.004) | 2.4 (0.094) | 1.3 (0.051) | N/A | 0.05 (0.002) | N/A | N/A | 0.13 (0.005) | 3.8 (0.150) | 274 |
| W | 7343-15 | 7.3 ±0.3 (0.287 ±0.012) | 4.3 ±0.3 (0.169 ±0.012) | 1.4 ±0.1 (0.055 ±0.004) | 2.4 (0.094) 2.8 ±0.2 (0.110 ±0.008) ^{*2} | 1.30 (0.051) S1 = 5.0 (0.197) ^{*2} S2 = 1.3 (0.051) ^{*2} | N/A | 0.05 (0.002) | N/A | N/A | 0.13 (0.005) | 3.8 (0.150) | 223 |
| X | 7343-43 | 7.3 ±0.3 (0.287 ±0.012) | 4.3 ±0.3 (0.169 ±0.012) | 4.0 ±0.3 (0.157 ±0.012) | 2.4 (0.094) | 1.3 (0.051) | 0.5 (0.020) | 0.10 ±0.10 (0.004 ±0.004) | 1.7 (0.067) | 1.0 (0.039) | 0.13 (0.005) | 3.8 (0.150) | 554 |
| Y | 7343-40 | 7.3 ±0.3 (0.287 ±0.012) | 4.3 ±0.3 (0.169 ±0.012) | 3.8 ±0.2 (0.150 ±0.008) | 2.4 (0.094) | 1.3 (0.051) | 0.5 (0.020) | 0.10 ±0.10 (0.004 ±0.004) | 1.7 (0.067) | 1.0 (0.039) | 0.13 (0.005) | 3.8 (0.150) | 494 |

*1 Height tolerance is ±0.2 for V case T521 only

*2 S1 and S2 is for T528 series only

*3 Height tolerance is ±0.2 for: T520B with M & N terminations

Dimensions – Millimeters cont.

T523

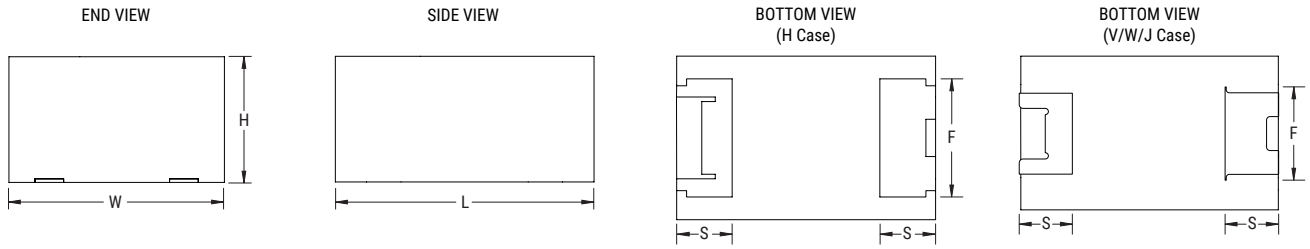

| KEMET | EIA | L | W | H | F ±0.1 (±0.004) | S ±0.3 (±0.012) | Typical Weight (mg) |
|-------|---------|--------------------------|--------------------------|--------------------------|--------------------|--------------------|------------------------|
| W | 7343-15 | 7.3±0.3 (0.287±0.012) | 4.3±0.3 (0.169±0.012) | 1.4±0.1 (0.055±0.004) | 2.4 (0.094) | 1.3 (0.051) | 223 |
| J | 7360-15 | 7.3±0.3 (0.287±0.012) | 6.0±0.3 (0.236±0.012) | 1.4±0.1 (0.055±0.004) | 4.45 (0.175) | 1.6 (0.063) | 263 |
| V | 7343-20 | 7.3±0.3 (0.287±0.012) | 4.3±0.3 (0.169±0.012) | 1.9±0.1 (0.075±0.004) | 2.4 (0.094) | 1.3 (0.051) | 274 |
| H | 7360-20 | 7.3±0.3 (0.287±0.012) | 6.0±0.3 (0.236±0.012) | 1.9±0.1 (0.075±0.004) | 4.45 (0.175) | 1.6 (0.063) | 385 |

T527/TF

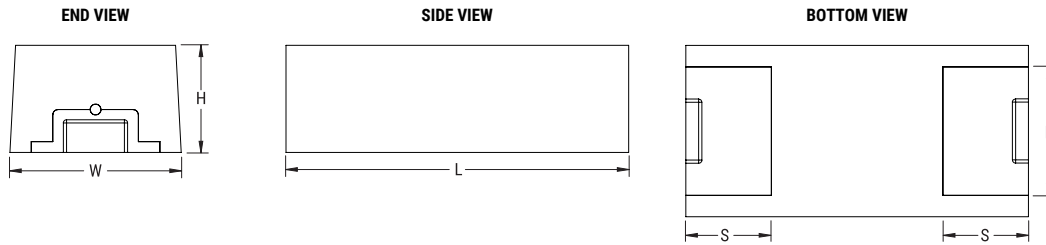

T527 B-Case/T-Case

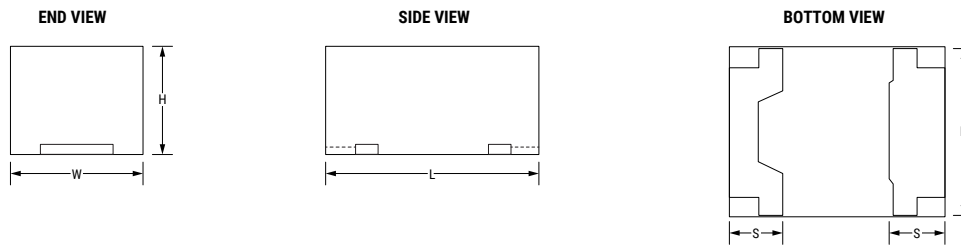

| Case Size | | Component Dimensions | | | | | Typical Weight |
|-----------|---------|----------------------|----------|-------------|----------|----------|----------------|
| KEMET | EIA | L | W | H | F | S | (mg) |
| I | 3216-10 | 3.2 ±0.2 | 1.6 ±0.2 | 0.9 ±0.1 | 1.2 ±0.1 | 0.8 ±0.2 | 70 |
| 08A | 3216-08 | 3.2 ±0.2 | 1.6 ±0.2 | 0.8 Maximum | 1.2 ±0.1 | 0.8 ±0.2 | - |
| K | 3528-10 | 3.5 ±0.2 | 2.8 ±0.2 | 1.0 Maximum | 2.2 ±0.1 | 0.7 ±0.2 | 70 |
| T | 3528-12 | 3.5 ±0.2 | 2.8 ±0.2 | 1.1 ±0.1 | 2.2 ±0.1 | 0.7 ±0.2 | 55 |
| S | 3216-12 | 3.2 ±0.2 | 1.6 ±0.2 | 1.1 ±0.1 | 1.2 ±0.1 | 0.8 ±0.2 | 26.2 |
| B | 3528-20 | 3.5 ±0.2 | 2.8 ±0.2 | 1.9 ±0.1 | 2.2 ±0.1 | 0.7 ±0.2 | 95 |

Dimensions – Millimeters cont.

T529

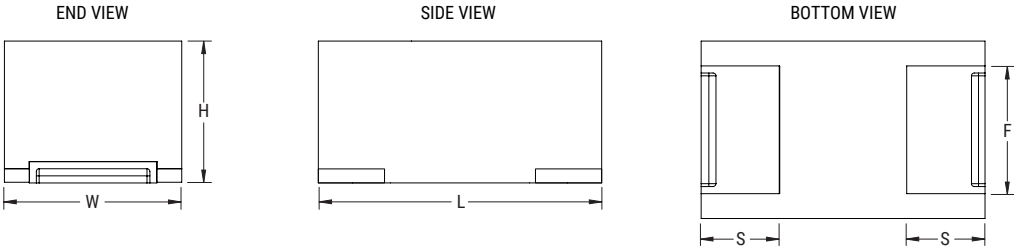

| Case Size | | Component Dimensions | | | | | Typical Weight |
|-----------|---------|----------------------|----------|-------------|---------|----------|----------------|
| KEMET | EIA | L | W | H | F | S | (mg) |
| P | 2012-10 | 2.0±0.1 | 1.25±0.1 | 1.0 maximum | 0.9±0.1 | 0.55±0.1 | 11.4 |
| I | 3216-10 | 3.2±0.2 | 1.6±0.2 | 1.0 maximum | 1.2±0.1 | 0.8±0.1 | 70 |

Table 1 – Ratings & Part Number Reference

| Rated Voltage VDC at 105°C | Rated Capacitance | Case Code/Case Size | KEMET Part Number | DC Leakage | DF | ESR | Maximum Allowable Ripple Current | Endurance | MSL | Maximum Operating Temperature | Derating Category |
|-------------------------------|-------------------|---------------------|------------------------------|-------------------------------|--------------------------|----------------------------|----------------------------------|-----------|---------------------|-------------------------------|-------------------|
| Not all parts are 105°C rated | µF | KEMET/EIA | (See below for part options) | µA at 25°C Maximum/ 5 Minutes | % at 25°C 120 Hz Maximum | mΩ at 25°C 100 kHz Maximum | (rms) mA at +45°C 100 kHz | (Hours) | Reflow Temp ≤ 260°C | °C | |
| 2 | 470 | V/7343-19 | T520V477M002A(3)E040 | 94 | 10 | 40 | 2,200 | 2,000 | 3 | 105 | 3 |
| 2.5 | 47 | A/3216-18 | T520A476M2R5ATE090 ^ | 11.75 | 8 * | 90 | 1,100 | 2,000 | 3 | 105 | 3 |
| 2.5 | 68 | A/3216-18 | T520A686M2R5ATE070 ^ | 17 | 8 * | 70 | 1,300 | 2,000 | 3 | 105 | 3 |
| 2.5 | 68 | A/3216-18 | T520A686M2R5ATE080 ^ | 17 | 8 * | 80 | 1,200 | 2,000 | 3 | 105 | 3 |
| 2.5 | 100 | T/3528-12 | T520T107M2R5A(3)E040 | 25 | 8 | 40 | 1,600 | 2,000 | 3 | 105 | 3 |
| 2.5 | 100 | T/3528-12 | T520T107M2R5A(3)E070 | 25 | 8 | 70 | 1,220 | 2,000 | 3 | 105 | 3 |
| 2.5 | 100 | T/3528-12 | T525T107M2R5A(3)E080 | 25 | 10 | 80 | 1,100 | 2,000 | 3 | 125 | 5 |
| 2.5 | 100 | B/3528-20 | T520B107M2R5A(3)E025 | 25 | 8 | 25 | 2,300 | 2,000 | 3 | 105 | 3 |
| 2.5 | 100 | B/3528-20 | T520B107M2R5A(3)E035 | 25 | 8 | 35 | 1,900 | 2,000 | 3 | 105 | 3 |
| 2.5 | 100 | B/3528-20 | T520B107M2R5A(3)E040 | 25 | 8 | 40 | 1,800 | 2,000 | 3 | 105 | 3 |
| 2.5 | 100 | B/3528-20 | T520B107M2R5A(3)E070 | 25 | 8 | 70 | 1,350 | 2,000 | 3 | 105 | 3 |
| 2.5 | 150 | U/6032-15 | T520U157M2R5A(3)E055 | 37.5 | 8 | 55 | 1,600 | 2,000 | 3 | 105 | 3 |
| 2.5 | 220 | A/3216-18 | T520A227M2R5ATE025 ^ | 55 | 8 * | 25 | 1,732 | 2,000 | 3 | 105 | 3 |
| 2.5 | 220 | A/3216-18 | T520A227M2R5ATE035 ^ | 55 | 8 * | 35 | 1,500 | 2,000 | 3 | 105 | 3 |
| 2.5 | 220 | B/3528-20 | T520B227M2R5A(3)E015 | 55 | 8 | 15 | 2,900 | 2,000 | 3 | 105 | 3 |
| 2.5 | 220 | B/3528-20 | T520B227M2R5A(3)E018 | 55 | 8 | 18 | 2,700 | 2,000 | 3 | 105 | 3 |
| 2.5 | 220 | B/3528-20 | T520B227M2R5A(3)E021 | 55 | 8 | 21 | 2,500 | 2,000 | 3 | 105 | 3 |
| 2.5 | 220 | B/3528-20 | T520B227M2R5A(3)E025 | 55 | 8 | 25 | 2,300 | 2,000 | 3 | 105 | 3 |
| 2.5 | 220 | B/3528-20 | T520B227M2R5A(3)E030 | 55 | 8 | 30 | 2,100 | 2,000 | 3 | 105 | 3 |
| 2.5 | 220 | B/3528-20 | T520B227M2R5A(3)E035 | 55 | 8 | 35 | 1,900 | 2,000 | 3 | 105 | 3 |
| 2.5 | 220 | B/3528-20 | T520B227M2R5A(3)E055 | 55 | 8 | 55 | 1,500 | 2,000 | 3 | 105 | 3 |
| 2.5 | 220 | B/3528-20 | T520B227M2R5A(3)E070 | 55 | 8 | 70 | 1,350 | 2,000 | 3 | 105 | 3 |
| 2.5 | 220 | T/3528-12 | T520T227M2R5ATE070 ^ | 55 | 10 * | 70 | 1,200 | 2,000 | 3 | 105 | 3 |
| 2.5 | 220 | T/3528-12 | T520T227M2R5ATE035 ^ | 55 | 8 * | 35 | 1,464 | 2,000 | 3 | 105 | 3 |
| 2.5 | 220 | T/3528-12 | T520T227M2R5ATE030 ^ | 55 | 10 * | 30 | 1,580 | 2,000 | 3 | 105 | 3 |
| 2.5 | 220 | U/6032-15 | T520U227M2R5A(3)E055 | 55 | 8 | 55 | 1,600 | 2,000 | 3 | 105 | 3 |
| 2.5 | 220 | C/6032-28 | T520C227M2R5A(3)E025 | 55 | 8 | 25 | 2,600 | 2,000 | 3 | 105 | 3 |
| 2.5 | 220 | C/6032-28 | T520C227M2R5A(3)E045 | 55 | 8 | 45 | 1,900 | 2,000 | 3 | 105 | 3 |
| 2.5 | 220 | W/7343-15 | T520W227M2R5A(3)E025 | 55 | 10 | 25 | 2,700 | 2,000 | 3 | 105 | 3 |
| 2.5 | 220 | V/7343-19 | T520V227M2R5A(3)E006 | 55 | 10 | 6 | 5,600 | 2,000 | 3 | 105 | 3 |
| 2.5 | 220 | V/7343-19 | T520V227M2R5A(3)E007 | 55 | 10 | 7 | 5,200 | 2,000 | 3 | 105 | 3 |
| 2.5 | 220 | V/7343-19 | T520V227M2R5A(3)E009 | 55 | 10 | 9 | 4,600 | 2,000 | 3 | 105 | 3 |
| 2.5 | 220 | V/7343-19 | T520V227M2R5A(3)E012 | 55 | 10 | 12 | 3,900 | 2,000 | 3 | 105 | 3 |
| 2.5 | 220 | V/7343-19 | T520V227M2R5A(3)E015 | 55 | 10 | 15 | 3,500 | 2,000 | 3 | 105 | 3 |
| 2.5 | 220 | V/7343-19 | T520V227M2R5A(3)E025 | 55 | 10 | 25 | 2,700 | 2,000 | 3 | 105 | 3 |
| 2.5 | 220 | V/7343-19 | T520V227M2R5A(3)E045 | 55 | 10 | 45 | 2,000 | 2,000 | 3 | 105 | 3 |
| 2.5 | 220 | D/7343-31 | T520D227M2R5A(3)E007 | 55 | 10 | 7 | 5,700 | 2,000 | 3 | 105 | 3 |
| 2.5 | 220 | D/7343-31 | T520D227M2R5A(3)E040 | 55 | 10 | 40 | 2,400 | 2,000 | 3 | 105 | 3 |
| 2.5 | 330 | T/3528-12 | T527T337M2R5APE020 ^ | 82.5 | 10 | 20 | 1,936 | 2,000 | 3 | 105 | 3 |
| 2.5 | 330 | T/3528-12 | T527T337M2R5APE025 ^ | 82.5 | 10 | 25 | 1,732 | 2,000 | 3 | 105 | 3 |
| 2.5 | 330 | T/3528-12 | T527T337M2R5APE030 ^ | 82.5 | 10 | 30 | 1,581 | 2,000 | 3 | 105 | 3 |
| VDC at 105°C | µF | KEMET/EIA | (See below for part options) | µA at 25°C Maximum/ 5 Minutes | % at 25°C 120 Hz Maximum | mΩ at 25°C 100 kHz Maximum | mA at +45°C 100 kHz | (Hours) | Reflow Temp ≤ 260°C | °C | |
| Rated Voltage | Rated Capacitance | Case Code/Case Size | KEMET Part Number | DC Leakage | DF | ESR | Maximum Allowable Ripple Current | Endurance | MSL | Maximum Operating Temp | Derating Category |

(2) To complete KEMET part number, insert M for ±20% or K for ±10%. Designates Capacitance tolerance.

(3) To complete KEMET part number, insert T = 100% Matte Tin (Sn)-plated or H = Standard Solder coated (SnPb 5% Pb minimum). Refer to Ordering Information for additional detail.

Higher voltage ratings and tighter ESR may be substituted within the same size at KEMET's option. Voltage substitutions will be marked with the higher voltage rating. Substitutions can include better than series.

Part numbers marked in blue font are not recommended for new designs. Please use the T521 series instead.

^ Denotes the large reel (13") is not available.

* DF measurement condition is 120 Hz/0.5 V_{rms}/1.5 V DC Bias

(1) ESR frequency condition is 300 - 500 kHz

Refer to Ordering Information for additional detail.

Table 1 – Ratings & Part Number Reference cont.

| Rated Voltage VDC at 105°C | Rated Capacitance | Case Code/Case Size | KEMET Part Number | DC Leakage | DF | ESR | Maximum Allowable Ripple Current | Endurance | MSL | Maximum Operating Temperature | Derating Category |
|-------------------------------|-------------------|---------------------|------------------------------|------------------------------|--------------------------|----------------------------|----------------------------------|-----------|---------------------|-------------------------------|-------------------|
| Not all parts are 105°C rated | µF | KEMET/EIA | (See below for part options) | µA at 25°C Maximum/5 Minutes | % at 25°C 120 Hz Maximum | mΩ at 25°C 100 kHz Maximum | (rms) mA at +45°C 100 kHz | (Hours) | Reflow Temp ≤ 260°C | °C | |
| 2.5 | 330 | B/3528-20 | T520B337M2R5ATE009 ^ | 82.5 | 8 * | 9 ⁽¹⁾ | 3,073 | 1,000 | 3 | 105 | 3 |
| 2.5 | 330 | B/3528-20 | T520B337M2R5NTE009 ^ | 82.5 | 8 * | 9 ⁽¹⁾ | 3,073 | 2,000 | 3 | 105 | 3 |
| 2.5 | 330 | B/3528-20 | T520B337M2R5ATE012 ^ | 83 | 8 * | 12 | 2,700 | 2,000 | 3 | 105 | 3 |
| 2.5 | 330 | B/3528-20 | T520B337M2R5A(3)E015 | 82.5 | 8 | 15 | 2,900 | 2,000 | 3 | 105 | 3 |
| 2.5 | 330 | B/3528-20 | T520B337M2R5A(3)E018 | 82.5 | 8 | 18 | 2,700 | 2,000 | 3 | 105 | 3 |
| 2.5 | 330 | B/3528-20 | T520B337M2R5A(3)E035 | 82.5 | 8 | 35 | 1,900 | 2,000 | 3 | 105 | 3 |
| 2.5 | 330 | B/3528-20 | T520B337M2R5A(3)E045 | 82.5 | 8 | 45 | 1,700 | 2,000 | 3 | 105 | 3 |
| 2.5 | 330 | B/3528-20 | T520B337M2R5A(3)E070 | 82.5 | 8 | 70 | 1,350 | 2,000 | 3 | 105 | 3 |
| 2.5 | 330 | C/6032-28 | T520C337M2R5A(3)E015 | 82.5 | 8 | 15 | 3,300 | 2,000 | 3 | 105 | 3 |
| 2.5 | 330 | C/6032-28 | T520C337M2R5A(3)E018 | 82.5 | 8 | 18 | 3,000 | 2,000 | 3 | 105 | 3 |
| 2.5 | 330 | C/6032-28 | T520C337M2R5A(3)E025 | 82.5 | 8 | 25 | 2,600 | 2,000 | 3 | 105 | 3 |
| 2.5 | 330 | C/6032-28 | T520C337M2R5A(3)E045 | 82.5 | 8 | 45 | 1,900 | 2,000 | 3 | 105 | 3 |
| 2.5 | 330 | L/6032-19 | T520L337M2R5A(3)E009 | 82.5 | 8 | 9 | 4,100 | 2,000 | 3 | 105 | 3 |
| 2.5 | 330 | L/6032-19 | T520L337M2R5A(3)E012 | 82.5 | 8 | 12 | 3,500 | 2,000 | 3 | 105 | 3 |
| 2.5 | 330 | L/6032-19 | T520L337M2R5A(3)E025 | 82.5 | 8 | 25 | 2,400 | 2,000 | 3 | 105 | 3 |
| 2.5 | 330 | W/7343-15 | T520W337M2R5A(3)E015 | 82.5 | 10 | 15 | 3,500 | 2,000 | 3 | 105 | 3 |
| 2.5 | 330 | W/7343-15 | T520W337M2R5A(3)E025 | 82.5 | 10 | 25 | 2,700 | 2,000 | 3 | 105 | 3 |
| 2.5 | 330 | W/7343-15 | T520W337M2R5A(3)E040 | 82.5 | 10 | 40 | 2,100 | 2,000 | 3 | 105 | 3 |
| 2.5 | 330 | V/7343-19 | T520V337M2R5A(3)E006 | 82.5 | 10 | 6 | 5,600 | 2,000 | 3 | 105 | 3 |
| 2.5 | 330 | V/7343-19 | T520V337M2R5A(3)E007 | 82.5 | 10 | 7 | 5,200 | 2,000 | 3 | 105 | 3 |
| 2.5 | 330 | V/7343-19 | T520V337M2R5A(3)E009 | 82.5 | 10 | 9 | 4,600 | 2,000 | 3 | 105 | 3 |
| 2.5 | 330 | V/7343-19 | T520V337M2R5A(3)E012 | 82.5 | 10 | 12 | 3,900 | 2,000 | 3 | 105 | 3 |
| 2.5 | 330 | V/7343-19 | T520V337M2R5A(3)E015 | 82.5 | 10 | 15 | 3,500 | 2,000 | 3 | 105 | 3 |
| 2.5 | 330 | V/7343-19 | T520V337M2R5A(3)E018 | 82.5 | 10 | 18 | 3,200 | 2,000 | 3 | 105 | 3 |
| 2.5 | 330 | V/7343-19 | T520V337M2R5A(3)E025 | 82.5 | 10 | 25 | 2,700 | 2,000 | 3 | 105 | 3 |
| 2.5 | 330 | V/7343-19 | T520V337M2R5A(3)E040 | 82.5 | 10 | 40 | 2,200 | 2,000 | 3 | 105 | 3 |
| 2.5 | 330 | D/7343-31 | T520D337M2R5A(3)E006 | 82.5 | 10 | 6 | 6,100 | 2,000 | 3 | 105 | 3 |
| 2.5 | 330 | D/7343-31 | T520D337M2R5A(3)E007 | 82.5 | 10 | 7 | 5,700 | 2,000 | 3 | 105 | 3 |
| 2.5 | 330 | D/7343-31 | T525D337M2R5A(3)E025 | 82.5 | 10 | 25 | 3,000 | 2,000 | 3 | 125 | 5 |
| 2.5 | 470 | B/3528-20 | T520B477M2R5ATE014 ^ | 188 | 8 * | 14 | 3,000 | 1,000 | 3 | 85 | 1 |
| 2.5 | 470 | V/7343-19 | T520V477M2R5A(3)E006 | 117.5 | 10 | 6 | 5,600 | 2,000 | 3 | 105 | 3 |
| 2.5 | 470 | V/7343-19 | T520V477M2R5A(3)E007 | 117.5 | 10 | 7 | 5,200 | 2,000 | 3 | 105 | 3 |
| 2.5 | 470 | V/7343-19 | T520V477M2R5A(3)E009 | 117.5 | 10 | 9 | 4,600 | 2,000 | 3 | 105 | 3 |
| 2.5 | 470 | V/7343-19 | T520V477M2R5A(3)E012 | 117.5 | 10 | 12 | 3,900 | 2,000 | 3 | 105 | 3 |
| 2.5 | 470 | V/7343-19 | T520V477M2R5A(3)E015 | 117.5 | 10 | 15 | 3,500 | 2,000 | 3 | 105 | 3 |
| 2.5 | 470 | V/7343-19 | T520V477M2R5A(3)E018 | 117.5 | 10 | 18 | 3,200 | 2,000 | 3 | 105 | 3 |
| 2.5 | 470 | C/6032-28 | T520C477M2R5A(3)E025 | 117.5 | 8 | 25 | 2,600 | 2,000 | 3 | 105 | 3 |
| 2.5 | 470 | C/6032-28 | T520C477M2R5A(3)E045 | 117.5 | 8 | 45 | 1,900 | 2,000 | 3 | 105 | 3 |
| 2.5 | 470 | D/7343-31 | T530D477M2R5A(3)E005 | 117.5 | 8 | 5 | 7,100 | 2,000 | 3 | 125 | 5 |
| 2.5 | 470 | D/7343-31 | T520D477M2R5A(3)E006 | 117.5 | 10 | 6 | 6,100 | 2,000 | 3 | 105 | 3 |
| 2.5 | 470 | D/7343-31 | T530D477M2R5A(3)E006 | 117.5 | 8 | 6 | 6,500 | 2,000 | 3 | 125 | 5 |
| VDC at 105°C | µF | KEMET/EIA | (See below for part options) | µA at 25°C Maximum/5 Minutes | % at 25°C 120 Hz Maximum | mΩ at 25°C 100 kHz Maximum | mA at +45°C 100 kHz | (Hours) | Reflow Temp ≤ 260°C | °C | |
| Rated Voltage | Rated Capacitance | Case Code/Case Size | KEMET Part Number | DC Leakage | DF | ESR | Maximum Allowable Ripple Current | Endurance | MSL | Maximum Operating Temp | Derating Category |

(2) To complete KEMET part number, insert M for ±20% or K for ±10%. Designates Capacitance tolerance.

(3) To complete KEMET part number, insert T = 100% Matte Tin (Sn)-plated or H = Standard Solder coated (SnPb 5% Pb minimum). Refer to Ordering Information for additional detail.

Higher voltage ratings and tighter ESR may be substituted within the same size at KEMET's option. Voltage substitutions will be marked with the higher voltage rating. Substitutions can include better than series.

Part numbers marked in blue font are not recommended for new designs. Please use the T521 series instead.

^ Denotes the large reel (13") is not available.

* DF measurement condition is 120 Hz/0.5 V_{rms}/1.5 V DC Bias

⁽¹⁾ ESR frequency condition is 300 - 500 kHz

Refer to Ordering Information for additional detail.

Table 1 – Ratings & Part Number Reference cont.

| Rated Voltage VDC at 105°C | Rated Capacitance | Case Code/Case Size | KEMET Part Number | DC Leakage | DF | ESR | Maximum Allowable Ripple Current | Endurance | MSL | Maximum Operating Temperature | Derating Category |
|-------------------------------|-------------------|---------------------|------------------------------|------------------------------|--------------------------|----------------------------|----------------------------------|-----------|---------------------|-------------------------------|-------------------|
| Not all parts are 105°C rated | µF | KEMET/EIA | (See below for part options) | µA at 25°C Maximum/5 Minutes | % at 25°C 120 Hz Maximum | mΩ at 25°C 100 kHz Maximum | (rms) mA at +45°C 100 kHz | (Hours) | Reflow Temp ≤ 260°C | °C | |
| 2.5 | 470 | D/7343-31 | T520D477M2R5A(3)E007 | 117.5 | 10 | 7 | 5,700 | 2,000 | 3 | 105 | 3 |
| 2.5 | 470 | D/7343-31 | T520D477M2R5A(3)E009 | 117.5 | 10 | 9 | 5,000 | 2,000 | 3 | 105 | 3 |
| 2.5 | 470 | D/7343-31 | T530D477M2R5A(3)E010 | 117.5 | 8 | 10 | 5,000 | 2,000 | 3 | 125 | 5 |
| 2.5 | 470 | D/7343-31 | T525D477M2R5A(3)E025 | 117.5 | 10 | 25 | 3,000 | 2,000 | 3 | 125 | 5 |
| 2.5 | 560 | D/7343-31 | T530D567M2R5A(3)E005 | 140 | 8 | 5 | 7,100 | 2,000 | 3 | 125 | 5 |
| 2.5 | 680 | D/7343-31 | T530D687M2R5A(3)E006 | 170 | 8 | 6 | 6,500 | 2,000 | 3 | 125 | 5 |
| 2.5 | 680 | D/7343-31 | T530D687M2R5A(3)E007 | 170 | 8 | 7 | 6,000 | 2,000 | 3 | 125 | 5 |
| 2.5 | 680 | D/7343-31 | T520D687M2R5A(3)E010 | 170 | 10 | 10 | 4,700 | 2,000 | 3 | 105 | 3 |
| 2.5 | 680 | D/7343-31 | T530D687M2R5A(3)E010 | 170 | 8 | 10 | 5,000 | 2,000 | 3 | 125 | 5 |
| 2.5 | 680 | D/7343-31 | T520D687M2R5A(3)E015 | 170 | 10 | 15 | 3,900 | 2,000 | 3 | 105 | 3 |
| 2.5 | 680 | D/7343-31 | T525D687M2R5A(3)E025 | 170 | 10 | 25 | 3,000 | 2,000 | 3 | 125 | 5 |
| 2.5 | 680 | D/7343-31 | T520D687M2R5A(3)E040 | 170 | 10 | 40 | 2,400 | 2,000 | 3 | 105 | 3 |
| 2.5 | 680 | Y/7343-40 | T530Y687M2R5A(3)E005 | 170 | 8 | 5 | 7,300 | 2,000 | 3 | 125 | 5 |
| 2.5 | 680 | Y/7343-40 | T530Y687M2R5A(3)E006 | 170 | 8 | 6 | 6,600 | 2,000 | 3 | 125 | 5 |
| 2.5 | 680 | Y/7343-40 | T530Y687M2R5A(3)E007 | 170 | 8 | 7 | 6,100 | 2,000 | 3 | 125 | 5 |
| 2.5 | 680 | Y/7343-40 | T520Y687M2R5A(3)E015 | 170 | 10 | 15 | 4,000 | 2,000 | 3 | 105 | 3 |
| 2.5 | 680 | Y/7343-40 | T520Y687M2R5A(3)E025 | 170 | 10 | 25 | 3,100 | 2,000 | 3 | 105 | 3 |
| 2.5 | 680 | X/7343-43 | T530X687M2R5A(3)E006 | 170 | 8 | 6 | 6,700 | 2,000 | 3 | 125 | 5 |
| 2.5 | 1000 | D/7343-31 | T520D108M2R5A(3)E006 | 250 | 10 | 6 | 6,100 | 2,000 | 3 | 105 | 3 |
| 2.5 | 1000 | D/7343-31 | T520D108M2R5A(3)E007 | 250 | 10 | 7 | 5,700 | 2,000 | 3 | 105 | 3 |
| 2.5 | 1000 | D/7343-31 | T520D108M2R5A(3)E009 | 250 | 10 | 9 | 5,000 | 2,000 | 3 | 105 | 3 |
| 2.5 | 1000 | D/7343-31 | T520D108M2R5A(3)E010 | 250 | 10 | 10 | 4,700 | 2,000 | 3 | 105 | 3 |
| 2.5 | 1000 | D/7343-31 | T520D108M2R5A(3)E015 | 250 | 10 | 15 | 3,900 | 2,000 | 3 | 105 | 3 |
| 2.5 | 1000 | D/7343-31 | T520D108M2R5A(3)E030 | 250 | 10 | 30 | 2,700 | 2,000 | 3 | 105 | 3 |
| 2.5 | 1000 | Y/7343-40 | T530Y108M2R5A(3)E005 | 250 | 8 | 5 | 7,300 | 2,000 | 3 | 125 | 5 |
| 2.5 | 1000 | Y/7343-40 | T530Y108M2R5A(3)E006 | 250 | 8 | 6 | 6,600 | 2,000 | 3 | 125 | 5 |
| 2.5 | 1000 | Y/7343-40 | T520Y108M2R5A(3)E010 | 250 | 10 | 10 | 4,900 | 2,000 | 3 | 105 | 3 |
| 2.5 | 1000 | Y/7343-40 | T520Y108M2R5A(3)E015 | 250 | 10 | 15 | 4,000 | 2,000 | 3 | 105 | 3 |
| 2.5 | 1000 | Y/7343-40 | T520Y108M2R5A(3)E025 | 250 | 10 | 25 | 3,100 | 2,000 | 3 | 105 | 3 |
| 2.5 | 1000 | X/7343-43 | T530X108M2R5A(3)E004 | 250 | 8 | 4 | 8,200 | 2,000 | 3 | 125 | 5 |
| 2.5 | 1000 | X/7343-43 | T530X108M2R5A(3)E005 | 250 | 8 | 5 | 7,300 | 2,000 | 3 | 125 | 5 |
| 2.5 | 1000 | X/7343-43 | T530X108M2R5A(3)E006 | 250 | 8 | 6 | 6,700 | 2,000 | 3 | 125 | 5 |
| 2.5 | 1000 | X/7343-43 | T520X108M2R5A(3)E010 | 250 | 10 | 10 | 5,000 | 2,000 | 3 | 105 | 3 |
| 2.5 | 1500 | Y/7343-40 | T520Y158M2R5A(3)E015 | 375 | 10 | 15 | 4,000 | 2,000 | 3 | 105 | 3 |
| 2.5 | 1500 | X/7343-43 | T530X158M2R5A(3)E005 | 375 | 8 | 5 | 7,300 | 2,000 | 3 | 125 | 5 |
| 2.5 | 1500 | X/7343-43 | T520X158M2R5A(3)E015 | 375 | 10 | 15 | 4,100 | 2,000 | 3 | 105 | 3 |
| 3 | 100 | B/3528-20 | T525B107M003A(3)E080 | 30 | 8 | 80 | 1,300 | 2,000 | 3 | 125 | 5 |
| 3 | 100 | B/3528-20 | T520B107M003A(3)E025 | 30 | 8 | 25 | 2,300 | 2,000 | 3 | 105 | 3 |
| 3 | 100 | B/3528-20 | T520B107M003A(3)E035 | 30 | 8 | 35 | 1,900 | 2,000 | 3 | 105 | 3 |
| 3 | 100 | B/3528-20 | T520B107M003A(3)E040 | 30 | 8 | 40 | 1,800 | 2,000 | 3 | 105 | 3 |
| 3 | 100 | B/3528-20 | T520B107M003A(3)E070 | 30 | 8 | 70 | 1,350 | 2,000 | 3 | 105 | 3 |
| VDC at 105°C | µF | KEMET/EIA | (See below for part options) | µA at 25°C Maximum/5 Minutes | % at 25°C 120 Hz Maximum | mΩ at 25°C 100 kHz Maximum | mA at +45°C 100 kHz | (Hours) | Reflow Temp ≤ 260°C | °C | |
| Rated Voltage | Rated Capacitance | Case Code/Case Size | KEMET Part Number | DC Leakage | DF | ESR | Maximum Allowable Ripple Current | Endurance | MSL | Maximum Operating Temp | Derating Category |

(2) To complete KEMET part number, insert M for ±20% or K for ±10%. Designates Capacitance tolerance.

(3) To complete KEMET part number, insert T = 100% Matte Tin (Sn)-plated or H = Standard Solder coated (SnPb 5% Pb minimum). Refer to Ordering Information for additional detail.

Higher voltage ratings and tighter ESR may be substituted within the same size at KEMET's option. Voltage substitutions will be marked with the higher voltage rating. Substitutions can include better than series.

Part numbers marked in blue font are not recommended for new designs. Please use the T521 series instead.

^ Denotes the large reel (13") is not available.

* DF measurement condition is 120 Hz/0.5 V_{rms}/1.5 V DC Bias

(1) ESR frequency condition is 300 - 500 kHz

Refer to Ordering Information for additional detail.

Table 1 – Ratings & Part Number Reference cont.

| Rated Voltage VDC at 105°C | Rated Capacitance | Case Code/Case Size | KEMET Part Number | DC Leakage | DF | ESR | Maximum Allowable Ripple Current | Endurance | MSL | Maximum Operating Temperature | Derating Category |
|-------------------------------|-------------------|---------------------|------------------------------|-------------------------------|--------------------------|----------------------------|----------------------------------|-----------|---------------------|-------------------------------|-------------------|
| Not all parts are 105°C rated | µF | KEMET/EIA | (See below for part options) | µA at 25°C Maximum/ 5 Minutes | % at 25°C 120 Hz Maximum | mΩ at 25°C 100 kHz Maximum | (rms) mA at +45°C 100 kHz | (Hours) | Reflow Temp ≤ 260°C | °C | |
| 3 | 150 | B/3528-20 | T520B157M003A(3)E025 | 45 | 8 | 25 | 2,300 | 2,000 | 3 | 105 | 3 |
| 3 | 150 | B/3528-20 | T520B157M003A(3)E035 | 45 | 8 | 35 | 1,900 | 2,000 | 3 | 105 | 3 |
| 3 | 150 | B/3528-20 | T520B157M003A(3)E040 | 45 | 8 | 40 | 1,800 | 2,000 | 3 | 105 | 3 |
| 3 | 150 | B/3528-20 | T520B157M003A(3)E070 | 45 | 8 | 70 | 1,350 | 2,000 | 3 | 105 | 3 |
| 3 | 150 | B/3528-20 | T525B157M003A(3)E080 | 45 | 8 | 80 | 1,300 | 2,000 | 3 | 125 | 5 |
| 3 | 330 | V/7343-19 | T520V337M003A(3)E009 | 99 | 10 | 9 | 4,600 | 2,000 | 3 | 105 | 3 |
| 3 | 330 | V/7343-19 | T520V337M003A(3)E012 | 99 | 10 | 12 | 3,900 | 2,000 | 3 | 105 | 3 |
| 3 | 330 | V/7343-19 | T520V337M003A(3)E015 | 99 | 10 | 15 | 3,500 | 2,000 | 3 | 105 | 3 |
| 3 | 330 | V/7343-19 | T520V337M003A(3)E025 | 99 | 10 | 25 | 2,700 | 2,000 | 3 | 105 | 3 |
| 3 | 330 | D/7343-31 | T525D337M003A(3)E025 | 99 | 10 | 25 | 3,000 | 2,000 | 3 | 125 | 5 |
| 3 | 470 | D/7343-31 | T530D477M003A(3)E010 | 141 | 8 | 10 | 5,000 | 2,000 | 3 | 125 | 5 |
| 3 | 470 | D/7343-31 | T525D477M003A(3)E025 | 141 | 10 | 25 | 3,000 | 2,000 | 3 | 125 | 5 |
| 3 | 680 | D/7343-31 | T530D687M003A(3)E010 | 204 | 8 | 10 | 5,000 | 2,000 | 3 | 125 | 5 |
| 3 | 680 | D/7343-31 | T520D687M003A(3)E015 | 204 | 10 | 15 | 3,900 | 2,000 | 3 | 105 | 3 |
| 3 | 680 | D/7343-31 | T525D687M003A(3)E025 | 204 | 10 | 25 | 3,000 | 2,000 | 3 | 125 | 5 |
| 3 | 680 | D/7343-31 | T520D687M003A(3)E040 | 204 | 10 | 40 | 2,400 | 2,000 | 3 | 105 | 3 |
| 3 | 1000 | X/7343-43 | T530X108M003A(3)E010 | 300 | 8 | 10 | 5,200 | 2,000 | 3 | 125 | 5 |
| 3 | 1000 | X/7343-43 | T520X108M003A(3)E015 | 300 | 10 | 15 | 4,100 | 2,000 | 3 | 105 | 3 |
| 3 | 1000 | X/7343-43 | T520X108M003A(3)E030 | 300 | 10 | 30 | 2,900 | 2,000 | 3 | 105 | 3 |
| 3 | 1500 | X/7343-43 | T530X158M003A(3)E008 | 450 | 8 | 8 | 5,800 | 2,000 | 3 | 125 | 5 |
| 4 | 15 | T/3528-12 | T520T156M004A(3)E100 | 6 | 8 | 100 | 1,000 | 2,000 | 3 | 105 | 3 |
| 4 | 33 | A/3216-18 | T520A336M004ATE070 ^ | 13.2 | 8* | 70 | 1,300 | 2,000 | 3 | 105 | 3 |
| 4 | 33 | A/3216-18 | T520A336M004ATE080 ^ | 13.2 | 8* | 80 | 1,200 | 2,000 | 3 | 105 | 3 |
| 4 | 47 | A/3216-18 | T520A476M004A(3)E070 ^ | 18.8 | 8* | 70 | 1,300 | 2,000 | 3 | 105 | 3 |
| 4 | 47 | A/3216-18 | T520A476M004ATE080 ^ | 18.8 | 8* | 80 | 1,200 | 2,000 | 3 | 105 | 3 |
| 4 | 47 | T/3528-12 | T520T476M004A(3)E070 | 18.8 | 8 | 70 | 1,220 | 2,000 | 3 | 105 | 3 |
| 4 | 68 | A/3216-18 | T520A686M004ATE180 ^ | 27 | 8* | 180 | 800 | 2,000 | 3 | 105 | 3 |
| 4 | 68 | T/3528-12 | T520T686M004A(3)E070 | 27.2 | 8 | 70 | 1,220 | 2,000 | 3 | 105 | 3 |
| 4 | 68 | B/3528-20 | T520B686M004A(3)E025 | 27.2 | 8 | 25 | 2,300 | 2,000 | 3 | 105 | 3 |
| 4 | 68 | B/3528-20 | T520B686M004A(3)E035 | 27.2 | 8 | 35 | 1,900 | 2,000 | 3 | 105 | 3 |
| 4 | 68 | B/3528-20 | T520B686M004A(3)E040 | 27.2 | 8 | 40 | 1,800 | 2,000 | 3 | 105 | 3 |
| 4 | 68 | B/3528-20 | T520B686M004A(3)E070 | 27.2 | 8 | 70 | 1,350 | 2,000 | 3 | 105 | 3 |
| 4 | 68 | B/3528-20 | T525B686M004A(3)E080 | 27.2 | 8 | 80 | 1,300 | 2,000 | 3 | 125 | 5 |
| 4 | 68 | U/6032-15 | T520U686M004A(3)E055 | 27.2 | 8 | 55 | 1,600 | 2,000 | 3 | 105 | 3 |
| 4 | 100 | I/3216-10 | T527I107M004ATE200 ^ | 40 | 8* | 200 | 775 | 1,000 | 3 | 105 | 3 |
| 4 | 100 | A/3216-18 | T520A107M004ATE150 ^ | 40 | 8* | 150 | 900 | 2,000 | 3 | 105 | 3 |
| 4 | 100 | A/3216-18 | T520A107M004ATE200 ^ | 40 | 8* | 200 | 700 | 2,000 | 3 | 105 | 3 |
| 4 | 100 | T/3528-12 | T520T107M004A(3)E070 | 40 | 8 | 70 | 1,220 | 2,000 | 3 | 105 | 3 |
| 4 | 100 | T/3528-12 | T520T107M004A(3)E150 | 40 | 8 | 150 | 800 | 2,000 | 3 | 105 | 3 |
| 4 | 100 | B/3528-20 | T520B107M004A(3)E025 | 40 | 8 | 25 | 2,300 | 2,000 | 3 | 105 | 3 |
| 4 | 100 | B/3528-20 | T520B107M004A(3)E035 | 40 | 8 | 35 | 1,900 | 2,000 | 3 | 105 | 3 |
| VDC at 105°C | µF | KEMET/EIA | (See below for part options) | µA at 25°C Maximum/ 5 Minutes | % at 25°C 120 Hz Maximum | mΩ at 25°C 100 kHz Maximum | mA at +45°C 100 kHz | (Hours) | Reflow Temp ≤ 260°C | °C | |
| Rated Voltage | Rated Capacitance | Case Code/Case Size | KEMET Part Number | DC Leakage | DF | ESR | Maximum Allowable Ripple Current | Endurance | MSL | Maximum Operating Temp | Derating Category |

(2) To complete KEMET part number, insert M for ±20% or K for ±10%. Designates Capacitance tolerance.

(3) To complete KEMET part number, insert T = 100% Matte Tin (Sn)-plated or H = Standard Solder coated (SnPb 5% Pb minimum). Refer to Ordering Information for additional detail.

Higher voltage ratings and tighter ESR may be substituted within the same size at KEMET's option. Voltage substitutions will be marked with the higher voltage rating. Substitutions can include better than series.

Part numbers marked in blue font are not recommended for new designs. Please use the T521 series instead.

^ Denotes the large reel (13") is not available.

* DF measurement condition is 120 Hz/0.5 V_{rms}/1.5 V DC Bias

(1) ESR frequency condition is 300 - 500 kHz

Refer to Ordering Information for additional detail.

T52X/T530 Polymer Electrolytic Capacitors
KEMET Organic Capacitor (KO-CAP®)

Table 1 – Ratings & Part Number Reference cont.

| Rated Voltage VDC at 105°C | Rated Capacitance | Case Code/Case Size | KEMET Part Number | DC Leakage | DF | ESR | Maximum Allowable Ripple Current | Endurance | MSL | Maximum Operating Temperature | Derating Category |
|-------------------------------|-------------------|---------------------|------------------------------|-------------------------------|--------------------------|----------------------------|----------------------------------|-----------|---------------------|-------------------------------|-------------------|
| Not all parts are 105°C rated | µF | KEMET/EIA | (See below for part options) | µA at 25°C Maximum/ 5 Minutes | % at 25°C 120 Hz Maximum | mΩ at 25°C 100 kHz Maximum | (rms) mA at +45°C 100 kHz | (Hours) | Reflow Temp ≤ 260°C | °C | |
| 4 | 100 | B/3528-20 | T520B107M004A(3)E040 | 40 | 8 | 40 | 1,800 | 2,000 | 3 | 105 | 3 |
| 4 | 100 | B/3528-20 | T520B107M004A(3)E070 | 40 | 8 | 70 | 1,350 | 2,000 | 3 | 105 | 3 |
| 4 | 100 | B/3528-20 | T525B107M004A(3)E080 | 40 | 8 | 80 | 1,300 | 2,000 | 3 | 125 | 5 |
| 4 | 100 | U/6032-15 | T520U107M004A(3)E055 | 40 | 8 | 55 | 1,600 | 2,000 | 3 | 105 | 3 |
| 4 | 150 | B/3528-20 | T520B157M004A(3)E015 | 60 | 8 | 15 | 2,900 | 2,000 | 3 | 105 | 3 |
| 4 | 150 | B/3528-20 | T520B157M004A(3)E018 | 60 | 8 | 18 | 2,700 | 2,000 | 3 | 105 | 3 |
| 4 | 150 | B/3528-20 | T520B157M004A(3)E025 | 60 | 8 | 25 | 2,300 | 2,000 | 3 | 105 | 3 |
| 4 | 150 | B/3528-20 | T520B157M004A(3)E030 | 60 | 8 | 30 | 2,100 | 2,000 | 3 | 105 | 3 |
| 4 | 150 | B/3528-20 | T520B157M004A(3)E035 | 60 | 8 | 35 | 1,900 | 2,000 | 3 | 105 | 3 |
| 4 | 150 | B/3528-20 | T520B157M004A(3)E040 | 60 | 8 | 40 | 1,800 | 2,000 | 3 | 105 | 3 |
| 4 | 150 | B/3528-20 | T520B157M004A(3)E070 | 60 | 8 | 70 | 1,350 | 2,000 | 3 | 105 | 3 |
| 4 | 150 | U/6032-15 | T520U157M004A(3)E055 | 60 | 8 | 55 | 1,600 | 2,000 | 3 | 105 | 3 |
| 4 | 150 | C/6032-28 | T520C157M004A(3)E015 | 60 | 8 | 15 | 3,300 | 2,000 | 3 | 105 | 3 |
| 4 | 150 | C/6032-28 | T520C157M004A(3)E025 | 60 | 8 | 25 | 2,600 | 2,000 | 3 | 105 | 3 |
| 4 | 150 | C/6032-28 | T520C157M004A(3)E045 | 60 | 8 | 45 | 1,900 | 2,000 | 3 | 105 | 3 |
| 4 | 150 | C/6032-28 | T520C157M004A(3)E100 | 60 | 8 | 100 | 1,300 | 2,000 | 3 | 105 | 3 |
| 4 | 150 | V/7343-19 | T520V157M004A(3)E007 | 60 | 10 | 7 | 5,200 | 2,000 | 3 | 105 | 3 |
| 4 | 150 | V/7343-19 | T520V157M004A(3)E009 | 60 | 10 | 9 | 4,600 | 2,000 | 3 | 105 | 3 |
| 4 | 150 | V/7343-19 | T520V157M004A(3)E012 | 60 | 10 | 12 | 3,900 | 2,000 | 3 | 105 | 3 |
| 4 | 150 | V/7343-19 | T520V157M004A(3)E015 | 60 | 10 | 15 | 3,500 | 2,000 | 3 | 105 | 3 |
| 4 | 150 | V/7343-19 | T520V157M004A(3)E025 | 60 | 10 | 25 | 2,700 | 2,000 | 3 | 105 | 3 |
| 4 | 150 | D/7343-31 | T520D157M004A(3)E007 | 60 | 10 | 7 | 5,700 | 2,000 | 3 | 105 | 3 |
| 4 | 220 | K/3528-10 | T527K227M004APE025 ^ | 88 | 10 * | 25 | 1,732 | 1,000 | 3 | 105 | 3 |
| 4 | 220 | K/3528-10 | T527K227M004APE030 ^ | 88 | 10 * | 30 | 1,581 | 1,000 | 3 | 105 | 3 |
| 4 | 220 | T/3528-12 | T520T227M004ATE025 ^ | 176 | 10 * | 25 | 2,050 | 2,000 | 3 | 105 | 3 |
| 4 | 220 | T/3528-12 | T520T227M004ATE030 ^ | 176 | 10 * | 30 | 1,870 | 2,000 | 3 | 105 | 3 |
| 4 | 220 | T/3528-12 | T520T227M004ATE035 ^ | 176 | 10 * | 35 | 1,463 | 2,000 | 3 | 105 | 3 |
| 4 | 220 | B/3528-20 | T520B227M004A(3)E035 | 88 | 8 | 35 | 1,900 | 2,000 | 3 | 105 | 3 |
| 4 | 220 | B/3528-20 | T520B227M004A(3)E045 | 88 | 8 | 45 | 1,700 | 2,000 | 3 | 105 | 3 |
| 4 | 220 | B/3528-20 | T520B227M004A(3)E070 | 88 | 8 | 70 | 1,350 | 2,000 | 3 | 105 | 3 |
| 4 | 220 | C/6032-28 | T520C227M004A(3)E015 | 88 | 8 | 15 | 3,300 | 2,000 | 3 | 105 | 3 |
| 4 | 220 | C/6032-28 | T520C227M004A(3)E018 | 88 | 8 | 18 | 3,000 | 2,000 | 3 | 105 | 3 |
| 4 | 220 | C/6032-28 | T520C227M004A(3)E025 | 88 | 8 | 25 | 2,600 | 2,000 | 3 | 105 | 3 |
| 4 | 220 | C/6032-28 | T520C227M004A(3)E045 | 88 | 8 | 45 | 1,900 | 2,000 | 3 | 105 | 3 |
| 4 | 220 | C/6032-28 | T520C227M004A(3)E055 | 88 | 8 | 55 | 1,700 | 2,000 | 3 | 105 | 3 |
| 4 | 220 | L/6032-19 | T520L227M004A(3)E012 | 88 | 8 | 12 | 3,500 | 2,000 | 3 | 105 | 3 |
| 4 | 220 | L/6032-19 | T520L227M004A(3)E025 | 88 | 8 | 25 | 2,400 | 2,000 | 3 | 105 | 3 |
| 4 | 220 | W/7343-15 | T520W227M004A(3)E025 | 88 | 10 | 25 | 2,700 | 2,000 | 3 | 105 | 3 |
| 4 | 220 | W/7343-15 | T520W227M004A(3)E040 | 88 | 10 | 40 | 2,100 | 2,000 | 3 | 105 | 3 |
| 4 | 220 | V/7343-19 | T520V227M004A(3)E006 | 88 | 10 | 6 | 5,600 | 2,000 | 3 | 105 | 3 |
| 4 | 220 | V/7343-19 | T520V227M004A(3)E007 | 88 | 10 | 7 | 5,200 | 2,000 | 3 | 105 | 3 |
| VDC at 105°C | µF | KEMET/EIA | (See below for part options) | µA at 25°C Maximum/ 5 Minutes | % at 25°C 120 Hz Maximum | mΩ at 25°C 100 kHz Maximum | mA at +45°C 100 kHz | (Hours) | Reflow Temp ≤ 260°C | °C | |
| Rated Voltage | Rated Capacitance | Case Code/Case Size | KEMET Part Number | DC Leakage | DF | ESR | Maximum Allowable Ripple Current | Endurance | MSL | Maximum Operating Temp | Derating Category |

(2) To complete KEMET part number, insert M for ±20% or K for ±10%. Designates Capacitance tolerance.

(3) To complete KEMET part number, insert T = 100% Matte Tin (Sn)-plated or H = Standard Solder coated (SnPb 5% Pb minimum). Refer to Ordering Information for additional detail.

Higher voltage ratings and tighter ESR may be substituted within the same size at KEMET's option. Voltage substitutions will be marked with the higher voltage rating. Substitutions can include better than series.

Part numbers marked in blue font are not recommended for new designs. Please use the T521 series instead.

^ Denotes the large reel (13") is not available.

* DF measurement condition is 120 Hz/0.5 V_{rms}/1.5 V DC Bias

(1) ESR frequency condition is 300 - 500 kHz

Refer to Ordering Information for additional detail.

Table 1 – Ratings & Part Number Reference cont.

| Rated Voltage VDC at 105°C | Rated Capacitance | Case Code/Case Size | KEMET Part Number | DC Leakage | DF | ESR | Maximum Allowable Ripple Current | Endurance | MSL | Maximum Operating Temperature | Derating Category |
|-------------------------------|-------------------|---------------------|------------------------------|------------------------------|--------------------------|----------------------------|----------------------------------|-----------|---------------------|-------------------------------|-------------------|
| Not all parts are 105°C rated | µF | KEMET/EIA | (See below for part options) | µA at 25°C Maximum/5 Minutes | % at 25°C 120 Hz Maximum | mΩ at 25°C 100 kHz Maximum | (rms) mA at +45°C 100 kHz | (Hours) | Reflow Temp ≤ 260°C | °C | |
| 4 | 220 | V/7343-19 | T520V227M004A(3)E009 | 88 | 10 | 9 | 4,600 | 2,000 | 3 | 105 | 3 |
| 4 | 220 | V/7343-19 | T520V227M004A(3)E012 | 88 | 10 | 12 | 3,900 | 2,000 | 3 | 105 | 3 |
| 4 | 220 | V/7343-19 | T520V227M004A(3)E015 | 88 | 10 | 15 | 3,500 | 2,000 | 3 | 105 | 3 |
| 4 | 220 | V/7343-19 | T520V227M004A(3)E018 | 88 | 10 | 18 | 3,200 | 2,000 | 3 | 105 | 3 |
| 4 | 220 | V/7343-19 | T520V227M004A(3)E025 | 88 | 10 | 25 | 2,700 | 2,000 | 3 | 105 | 3 |
| 4 | 220 | V/7343-19 | T520V227M004A(3)E040 | 88 | 10 | 40 | 2,200 | 2,000 | 3 | 105 | 3 |
| 4 | 220 | V/7343-19 | T520V227M004A(3)E045 | 88 | 10 | 45 | 2,000 | 2,000 | 3 | 105 | 3 |
| 4 | 220 | D/7343-31 | T520D227M004A(3)E006 | 88 | 10 | 6 | 6,100 | 2,000 | 3 | 105 | 3 |
| 4 | 220 | D/7343-31 | T520D227M004A(3)E007 | 88 | 10 | 7 | 5,700 | 2,000 | 3 | 105 | 3 |
| 4 | 220 | D/7343-31 | T520D227M004A(3)E012 | 88 | 10 | 12 | 4,300 | 2,000 | 3 | 105 | 3 |
| 4 | 220 | D/7343-31 | T525D227M004A(3)E025 | 88 | 10 | 25 | 3,000 | 2,000 | 3 | 125 | 5 |
| 4 | 220 | D/7343-31 | T520D227M004A(3)E065 | 88 | 10 | 65 | 1,900 | 2,000 | 3 | 105 | 3 |
| 4 | 330 | C/6032-28 | T520C337M004A(3)E025 | 132 | 8 | 25 | 2,600 | 2,000 | 3 | 105 | 3 |
| 4 | 330 | C/6032-28 | T520C337M004A(3)E045 | 132 | 8 | 45 | 1,900 | 2,000 | 3 | 105 | 3 |
| 4 | 330 | V/7343-19 | T520V337M004A(3)E007 | 132 | 10 | 7 | 5,200 | 2,000 | 3 | 105 | 3 |
| 4 | 330 | V/7343-19 | T520V337M004A(3)E009 | 132 | 10 | 9 | 4,600 | 2,000 | 3 | 105 | 3 |
| 4 | 330 | V/7343-19 | T520V337M004A(3)E012 | 132 | 10 | 12 | 3,900 | 2,000 | 3 | 105 | 3 |
| 4 | 330 | V/7343-19 | T520V337M004A(3)E018 | 132 | 10 | 18 | 3,200 | 2,000 | 3 | 105 | 3 |
| 4 | 330 | V/7343-19 | T520V337M004A(3)E025 | 132 | 10 | 25 | 2,700 | 2,000 | 3 | 105 | 3 |
| 4 | 330 | V/7343-19 | T520V337M004A(3)E040 | 132 | 10 | 40 | 2,200 | 2,000 | 3 | 105 | 3 |
| 4 | 330 | D/7343-31 | T530D337M004A(3)E005 | 132 | 8 | 5 | 7,100 | 2,000 | 3 | 125 | 5 |
| 4 | 330 | D/7343-31 | T520D337M004A(3)E006 | 132 | 10 | 6 | 6,100 | 2,000 | 3 | 105 | 3 |
| 4 | 330 | D/7343-31 | T530D337M004A(3)E006 | 132 | 8 | 6 | 6,500 | 2,000 | 3 | 125 | 5 |
| 4 | 330 | D/7343-31 | T520D337M004A(3)E007 | 132 | 10 | 7 | 5,700 | 2,000 | 3 | 105 | 3 |
| 4 | 330 | D/7343-31 | T520D337M004A(3)E009 | 132 | 10 | 9 | 5,000 | 2,000 | 3 | 105 | 3 |
| 4 | 330 | D/7343-31 | T520D337M004A(3)E012 | 132 | 10 | 12 | 4,300 | 2,000 | 3 | 105 | 3 |
| 4 | 330 | D/7343-31 | T520D337M004A(3)E015 | 132 | 10 | 15 | 3,900 | 2,000 | 3 | 105 | 3 |
| 4 | 330 | D/7343-31 | T525D337M004A(3)E025 | 132 | 10 | 25 | 3,000 | 2,000 | 3 | 125 | 5 |
| 4 | 330 | D/7343-31 | T520D337M004A(3)E040 | 132 | 10 | 40 | 2,400 | 2,000 | 3 | 105 | 3 |
| 4 | 330 | D/7343-31 | T520D337M004A(3)E045 | 132 | 10 | 45 | 2,200 | 2,000 | 3 | 105 | 3 |
| 4 | 470 | D/7343-31 | T530D477M004A(3)E006 | 188 | 8 | 6 | 6,500 | 2,000 | 3 | 125 | 5 |
| 4 | 470 | D/7343-31 | T520D477M004A(3)E010 | 188 | 10 | 10 | 4,700 | 2,000 | 3 | 105 | 3 |
| 4 | 470 | D/7343-31 | T530D477M004A(3)E010 | 188 | 8 | 10 | 5,000 | 2,000 | 3 | 125 | 5 |
| 4 | 470 | D/7343-31 | T520D477M004A(3)E012 | 188 | 10 | 12 | 4,300 | 2,000 | 3 | 105 | 3 |
| 4 | 470 | D/7343-31 | T520D477M004A(3)E015 | 188 | 10 | 15 | 3,900 | 2,000 | 3 | 105 | 3 |
| 4 | 470 | D/7343-31 | T520D477M004A(3)E018 | 188 | 10 | 18 | 3,500 | 2,000 | 3 | 105 | 3 |
| 4 | 470 | D/7343-31 | T520D477M004A(3)E025 | 188 | 10 | 25 | 3,000 | 2,000 | 3 | 105 | 3 |
| 4 | 470 | D/7343-31 | T525D477M004A(3)E025 | 188 | 10 | 25 | 3,000 | 2,000 | 3 | 125 | 5 |
| 4 | 470 | D/7343-31 | T520D477M004A(3)E040 | 188 | 10 | 40 | 2,400 | 2,000 | 3 | 105 | 3 |
| 4 | 470 | D/7343-31 | T525D477M004A(3)E040 | 188 | 10 | 40 | 2,400 | 2,000 | 3 | 125 | 5 |
| 4 | 470 | Y/7343-40 | T530Y477M004A(3)E005 | 188 | 8 | 5 | 7,300 | 2,000 | 3 | 125 | 5 |
| VDC at 105°C | µF | KEMET/EIA | (See below for part options) | µA at 25°C Maximum/5 Minutes | % at 25°C 120 Hz Maximum | mΩ at 25°C 100 kHz Maximum | mA at +45°C 100 kHz | (Hours) | Reflow Temp ≤ 260°C | °C | |
| Rated Voltage | Rated Capacitance | Case Code/Case Size | KEMET Part Number | DC Leakage | DF | ESR | Maximum Allowable Ripple Current | Endurance | MSL | Maximum Operating Temp | Derating Category |

(2) To complete KEMET part number, insert M for ±20% or K for ±10%. Designates Capacitance tolerance.

(3) To complete KEMET part number, insert T = 100% Matte Tin (Sn)-plated or H = Standard Solder coated (SnPb 5% Pb minimum). Refer to Ordering Information for additional detail.

Higher voltage ratings and tighter ESR may be substituted within the same size at KEMET's option. Voltage substitutions will be marked with the higher voltage rating. Substitutions can include better than series.

Part numbers marked in blue font are not recommended for new designs. Please use the T521 series instead.

^ Denotes the large reel (13") is not available.

* DF measurement condition is 120 Hz/0.5 V_{rms}/1.5 V DC Bias

(1) ESR frequency condition is 300 - 500 kHz

Refer to Ordering Information for additional detail.

Table 1 – Ratings & Part Number Reference cont.

| Rated Voltage VDC at 105°C | Rated Capacitance | Case Code/Case Size | KEMET Part Number | DC Leakage | DF | ESR | Maximum Allowable Ripple Current | Endurance | MSL | Maximum Operating Temperature | Derating Category |
|-------------------------------|-------------------|---------------------|------------------------------|------------------------------|--------------------------|----------------------------|----------------------------------|-----------|---------------------|-------------------------------|-------------------|
| Not all parts are 105°C rated | µF | KEMET/EIA | (See below for part options) | µA at 25°C Maximum/5 Minutes | % at 25°C 120 Hz Maximum | mΩ at 25°C 100 kHz Maximum | (rms) mA at +45°C 100 kHz | (Hours) | Reflow Temp ≤ 260°C | °C | |
| 4 | 470 | Y/7343-40 | T530Y477M004A(3)E006 | 188 | 8 | 6 | 6,600 | 2,000 | 3 | 125 | 5 |
| 4 | 680 | D/7343-31 | T520D687M004A(3)E012 | 272 | 10 | 12 | 4,300 | 2,000 | 3 | 105 | 3 |
| 4 | 680 | D/7343-31 | T520D687M004A(3)E015 | 272 | 10 | 15 | 3,900 | 2,000 | 3 | 105 | 3 |
| 4 | 680 | D/7343-31 | T520D687M004A(3)E025 | 272 | 10 | 25 | 3,000 | 2,000 | 3 | 105 | 3 |
| 4 | 680 | Y/7343-40 | T530Y687M004A(3)E005 | 272 | 8 | 5 | 7,300 | 2,000 | 3 | 125 | 5 |
| 4 | 680 | Y/7343-40 | T520Y687M004A(3)E010 | 272 | 10 | 10 | 4,900 | 2,000 | 3 | 105 | 3 |
| 4 | 680 | Y/7343-40 | T520Y687M004A(3)E015 | 272 | 10 | 15 | 4,000 | 2,000 | 3 | 105 | 3 |
| 4 | 680 | Y/7343-40 | T520Y687M004A(3)E025 | 272 | 10 | 25 | 3,100 | 2,000 | 3 | 105 | 3 |
| 4 | 680 | X/7343-43 | T530X687M004A(3)E004 | 272 | 8 | 4 | 8,200 | 2,000 | 3 | 125 | 5 |
| 4 | 680 | X/7343-43 | T530X687M004A(3)E005 | 272 | 8 | 5 | 7,300 | 2,000 | 3 | 125 | 5 |
| 4 | 680 | X/7343-43 | T530X687M004A(3)E006 | 272 | 8 | 6 | 6,700 | 2,000 | 3 | 125 | 5 |
| 4 | 680 | X/7343-43 | T520X687M004A(3)E010 | 272 | 10 | 10 | 5,000 | 2,000 | 3 | 105 | 3 |
| 4 | 680 | X/7343-43 | T530X687M004A(3)E010 | 272 | 8 | 10 | 5,200 | 2,000 | 3 | 125 | 5 |
| 4 | 680 | X/7343-43 | T520X687M004A(3)E015 | 272 | 10 | 15 | 4,100 | 2,000 | 3 | 105 | 3 |
| 4 | 680 | X/7343-43 | T520X687M004A(3)E035 | 272 | 10 | 35 | 2,700 | 2,000 | 3 | 105 | 3 |
| 4 | 1000 | X/7343-43 | T530X108M004A(3)E006 | 400 | 8 | 6 | 6,700 | 2,000 | 3 | 125 | 5 |
| 6.3 | 15 | T/3528-12 | T520T156M006A(3)E100 | 9.45 | 8 | 100 | 1,000 | 2,000 | 3 | 105 | 3 |
| 6.3 | 10 | P/2012-10 | T529P106M006AAE200 ^ | 18.9 | 6 * | 200 | 354 | 1,000 | 3 | 105 | 3 |
| 6.3 | 22 | P/2012-10 | T529P226M006AAE150 ^ | 22 | 6 * | 150 | 408 | 1,000 | 3 | 105 | 3 |
| 6.3 | 22 | P/2012-10 | T529P226M006AAE200 ^ | 22 | 6 * | 200 | 354 | 1,000 | 3 | 105 | 3 |
| 6.3 | 22 | A/3216-18 | T520A226M006ATE090 ^ | 13.86 | 8 * | 90 | 1,100 | 2,000 | 3 | 105 | 3 |
| 6.3 | 22 | A/3216-18 | T520A226M006ATE100 ^ | 13.86 | 8 * | 100 | 1,100 | 2,000 | 3 | 105 | 3 |
| 6.3 | 22 | T/3528-12 | T520T226M006A(3)E100 | 13.86 | 8 | 100 | 1,000 | 2,000 | 3 | 105 | 3 |
| 6.3 | 33 | A/3216-18 | T520A336M006A(3)E070 ^ | 20.79 | 8 * | 70 | 1,300 | 2,000 | 3 | 105 | 3 |
| 6.3 | 33 | A/3216-18 | T520A336M006A(3)E080 ^ | 20.79 | 8 * | 80 | 1,200 | 2,000 | 3 | 105 | 3 |
| 6.3 | 33 | A/3216-18 | T520A336M006A(3)E120 ^ | 20.79 | 8 * | 120 | 1,000 | 2,000 | 3 | 105 | 3 |
| 6.3 | 33 | T/3528-12 | T520T336M006A(3)E070 | 20.79 | 8 | 70 | 1,220 | 2,000 | 3 | 105 | 3 |
| 6.3 | 33 | B/3528-20 | T520B336M006A(3)E025 | 20.79 | 8 | 25 | 2,300 | 2,000 | 3 | 105 | 3 |
| 6.3 | 33 | B/3528-20 | T520B336M006A(3)E035 | 20.79 | 8 | 35 | 1,900 | 2,000 | 3 | 105 | 3 |
| 6.3 | 33 | B/3528-20 | T520B336M006A(3)E040 | 20.79 | 8 | 40 | 1,800 | 2,000 | 3 | 105 | 3 |
| 6.3 | 33 | B/3528-20 | T520B336M006A(3)E070 | 20.79 | 8 | 70 | 1,350 | 2,000 | 3 | 105 | 3 |
| 6.3 | 33 | B/3528-20 | T525B336M006A(3)E080 | 20.79 | 8 | 80 | 1,300 | 2,000 | 3 | 125 | 5 |
| 6.3 | 33 | C/6032-28 | T520C336M006A(3)E100 | 20.79 | 8 | 100 | 1,300 | 2,000 | 3 | 105 | 3 |
| 6.3 | 47 | P/2012-10 | T529P476M006AAE200 ^ | 29.61 | 6 * | 200 | 354 | 1,000 | 3 | 105 | 4 |
| 6.3 | 47 | P/2012-10 | T529P476M006AAE150 ^ | 29.6 | 6 * | 150 | 408 | 1,000 | 3 | 105 | 4 |
| 6.3 | 47 | 3216-08 | TF08A476M006APE150 ^ | 29.6 | 10 * | 150 | 632 | 1,000 | 3 | 105 | 3 |
| 6.3 | 47 | I/3216-10 | T527I476M006ATE200 ^ | 29.6 | 6 * | 200 | 548 | 1,000 | 3 | 105 | 3 |
| 6.3 | 47 | A/3216-18 | T520A476M006ATE150 ^ | 29.61 | 8 * | 150 | 900 | 2,000 | 3 | 105 | 3 |
| 6.3 | 47 | T/3528-12 | T520T476M006A(3)E040 | 29.61 | 8 | 40 | 1,600 | 2,000 | 3 | 105 | 3 |
| 6.3 | 47 | T/3528-12 | T520T476M006A(3)E070 | 29.61 | 8 | 70 | 1,220 | 2,000 | 3 | 105 | 3 |
| 6.3 | 47 | T/3528-12 | T525T476M006A(3)E080 | 29.61 | 8 | 80 | 1,100 | 2,000 | 3 | 125 | 5 |
| VDC at 105°C | µF | KEMET/EIA | (See below for part options) | µA at 25°C Maximum/5 Minutes | % at 25°C 120 Hz Maximum | mΩ at 25°C 100 kHz Maximum | mA at +45°C 100 kHz | (Hours) | Reflow Temp ≤ 260°C | °C | |
| Rated Voltage | Rated Capacitance | Case Code/Case Size | KEMET Part Number | DC Leakage | DF | ESR | Maximum Allowable Ripple Current | Endurance | MSL | Maximum Operating Temp | Derating Category |

(2) To complete KEMET part number, insert M for ±20% or K for ±10%. Designates Capacitance tolerance.

(3) To complete KEMET part number, insert T = 100% Matte Tin (Sn)-plated or H = Standard Solder coated (SnPb 5% Pb minimum). Refer to Ordering Information for additional detail.

Higher voltage ratings and tighter ESR may be substituted within the same size at KEMET's option. Voltage substitutions will be marked with the higher voltage rating. Substitutions can include better than series.

Part numbers marked in blue font are not recommended for new designs. Please use the T521 series instead.

^ Denotes the large reel (13") is not available.

* DF measurement condition is 120 Hz/0.5 V_{rms}/1.5 V DC Bias

(1) ESR frequency condition is 300 - 500 kHz

Refer to Ordering Information for additional detail.

T52X/T530 Polymer Electrolytic Capacitors
KEMET Organic Capacitor (KO-CAP®)

Table 1 – Ratings & Part Number Reference cont.

| Rated Voltage VDC at 105°C | Rated Capacitance | Case Code/Case Size | KEMET Part Number | DC Leakage | DF | ESR | Maximum Allowable Ripple Current | Endurance | MSL | Maximum Operating Temperature | Derating Category |
|-------------------------------|-------------------|---------------------|------------------------------|-------------------------------|--------------------------|----------------------------|----------------------------------|-----------|---------------------|-------------------------------|-------------------|
| Not all parts are 105°C rated | µF | KEMET/EIA | (See below for part options) | µA at 25°C Maximum/ 5 Minutes | % at 25°C 120 Hz Maximum | mΩ at 25°C 100 kHz Maximum | (rms) mA at +45°C 100 kHz | (Hours) | Reflow Temp ≤ 260°C | °C | |
| 6.3 | 47 | B/3528-20 | T520B476M006A(3)E025 | 29.61 | 8 | 25 | 2,300 | 2,000 | 3 | 105 | 3 |
| 6.3 | 47 | B/3528-20 | T520B476M006A(3)E035 | 29.61 | 8 | 35 | 1,900 | 2,000 | 3 | 105 | 3 |
| 6.3 | 47 | B/3528-20 | T520B476M006A(3)E040 | 29.61 | 8 | 40 | 1,800 | 2,000 | 3 | 105 | 3 |
| 6.3 | 47 | B/3528-20 | T520B476M006A(3)E070 | 29.61 | 8 | 70 | 1,350 | 2,000 | 3 | 105 | 3 |
| 6.3 | 47 | B/3528-20 | T525B476M006A(3)E070 | 29.61 | 8 | 70 | 1,350 | 2,000 | 3 | 125 | 5 |
| 6.3 | 47 | B/3528-20 | T525B476M006A(3)E080 | 29.61 | 8 | 80 | 1,300 | 2,000 | 3 | 125 | 5 |
| 6.3 | 68 | A/3216-18 | T520A686M006ATE150 ^ | 42.84 | 8 * | 150 | 900 | 2,000 | 3 | 105 | 3 |
| 6.3 | 68 | T/3528-12 | T520T686M006A(3)E070 | 42.84 | 8 | 70 | 1,220 | 2,000 | 3 | 105 | 3 |
| 6.3 | 68 | T/3528-12 | T520T686M006A(3)E150 | 42.84 | 8 | 150 | 800 | 2,000 | 3 | 105 | 3 |
| 6.3 | 68 | B/3528-20 | T520B686M006A(3)E025 | 42.84 | 8 | 25 | 2,300 | 2,000 | 3 | 105 | 3 |
| 6.3 | 68 | B/3528-20 | T520B686M006A(3)E035 | 42.84 | 8 | 35 | 1,900 | 2,000 | 3 | 105 | 3 |
| 6.3 | 68 | B/3528-20 | T520B686M006A(3)E040 | 42.84 | 8 | 40 | 1,800 | 2,000 | 3 | 105 | 3 |
| 6.3 | 68 | B/3528-20 | T520B686M006A(3)E070 | 42.84 | 8 | 70 | 1,350 | 2,000 | 3 | 105 | 3 |
| 6.3 | 68 | B/3528-20 | T525B686M006A(3)E080 | 42.84 | 8 | 80 | 1,300 | 2,000 | 3 | 125 | 5 |
| 6.3 | 68 | U/6032-15 | T520U686M006A(3)E055 | 42.84 | 8 | 55 | 1,600 | 2,000 | 3 | 105 | 3 |
| 6.3 | 68 | U/6032-15 | T520U686M006A(3)E070 | 42.84 | 8 | 70 | 1,400 | 2,000 | 3 | 105 | 3 |
| 6.3 | 68 | C/6032-28 | T520C686M006A(3)E100 | 42.84 | 8 | 100 | 1,300 | 2,000 | 3 | 105 | 3 |
| 6.3 | 100 | I/3216-10 | T527I107M006ATE200 ^ | 63.0 | 8 * | 200 | 775 | 1,000 | 3 | 105 | 3 |
| 6.3 | 100 | I/3216-10 | T527I107M006ATE100 ^ | 63.0 | 8 * | 100 | 775 | 1,000 | 3 | 105 | 3 |
| 6.3 | 100 | I/3216-10 | T527I107M006ATE070 ^ | 63.0 | 8 * | 70 | 1,134 | 1,000 | 3 | 105 | 3 |
| 6.3 | 100 | I/3216-10 | T527I107M006ATE055 ^ | 63.0 | 8 * | 55 | 1,044 | 1,000 | 3 | 105 | 3 |
| 6.3 | 100 | A/3216-18 | T520A107M006ATE070 ^ | 63.0 | 8 * | 70 | 1,035 | 2,000 | 3 | 105 | 3 |
| 6.3 | 100 | A/3216-18 | T520A107M006ATE045 ^ | 63.0 | 8 * | 45 | 1,600 | 2,000 | 3 | 105 | 3 |
| 6.3 | 100 | A/3216-18 | T520A107M006ATE035 ^ | 63.0 | 8 * | 35 | 1,500 | 2,000 | 3 | 105 | 3 |
| 6.3 | 100 | A/3216-18 | T520A107M006ATE025 ^ | 63.0 | 8 * | 25 | 1,732 | 2,000 | 3 | 105 | 3 |
| 6.3 | 100 | T/3528-12 | T520T107M006APE070 | 63.0 | 8 | 70 | 1,220 | 2,000 | 3 | 105 | 3 |
| 6.3 | 100 | T/3528-12 | T520T107M006APE055 | 63.0 | 8 | 55 | 1,380 | 2,000 | 3 | 105 | 3 |
| 6.3 | 100 | B/3528-20 | T520B107M006A(3)E015 | 63.0 | 8 | 15 | 2,900 | 2,000 | 3 | 105 | 3 |
| 6.3 | 100 | B/3528-20 | T520B107M006A(3)E018 | 63.0 | 8 | 18 | 2,700 | 2,000 | 3 | 105 | 3 |
| 6.3 | 100 | B/3528-20 | T520B107M006A(3)E025 | 63.0 | 8 | 25 | 2,300 | 2,000 | 3 | 105 | 3 |
| 6.3 | 100 | B/3528-20 | T520B107M006A(3)E035 | 63.0 | 8 | 35 | 1,900 | 2,000 | 3 | 105 | 3 |
| 6.3 | 100 | B/3528-20 | T520B107M006A(3)E040 | 63.0 | 8 | 40 | 1,800 | 2,000 | 3 | 105 | 3 |
| 6.3 | 100 | B/3528-20 | T520B107M006A(3)E045 | 63.0 | 8 | 45 | 1,700 | 2,000 | 3 | 105 | 3 |
| 6.3 | 100 | B/3528-20 | T520B107M006A(3)E070 | 63.0 | 8 | 70 | 1,350 | 2,000 | 3 | 105 | 3 |
| 6.3 | 100 | U/6032-15 | T520U107M006A(3)E055 | 63.0 | 8 | 55 | 1,600 | 2,000 | 3 | 105 | 3 |
| 6.3 | 100 | W/7343-15 | T520W107M006A(3)E040 | 63.0 | 10 | 40 | 2,100 | 2,000 | 3 | 105 | 3 |
| 6.3 | 100 | V/7343-19 | T520V107M006A(3)E007 | 63.0 | 10 | 7 | 5,170 | 2,000 | 3 | 105 | 3 |
| 6.3 | 100 | V/7343-19 | T520V107M006A(3)E009 | 63.0 | 10 | 9 | 4,600 | 2,000 | 3 | 105 | 3 |
| 6.3 | 100 | V/7343-19 | T520V107M006A(3)E012 | 63.0 | 10 | 12 | 3,900 | 2,000 | 3 | 105 | 3 |
| 6.3 | 100 | V/7343-19 | T520V107M006A(3)E015 | 63.0 | 10 | 15 | 3,500 | 2,000 | 3 | 105 | 3 |
| 6.3 | 100 | V/7343-19 | T520V107M006A(3)E045 | 63.0 | 10 | 45 | 2,000 | 2,000 | 3 | 105 | 3 |
| VDC at 105°C | µF | KEMET/EIA | (See below for part options) | µA at 25°C Maximum/ 5 Minutes | % at 25°C 120 Hz Maximum | mΩ at 25°C 100 kHz Maximum | mA at +45°C 100 kHz | (Hours) | Reflow Temp ≤ 260°C | °C | |
| Rated Voltage | Rated Capacitance | Case Code/Case Size | KEMET Part Number | DC Leakage | DF | ESR | Maximum Allowable Ripple Current | Endurance | MSL | Maximum Operating Temp | Derating Category |

(2) To complete KEMET part number, insert M for ±20% or K for ±10%. Designates Capacitance tolerance.

(3) To complete KEMET part number, insert T = 100% Matte Tin (Sn)-plated or H = Standard Solder coated (SnPb 5% Pb minimum). Refer to Ordering Information for additional detail.

Higher voltage ratings and tighter ESR may be substituted within the same size at KEMET's option. Voltage substitutions will be marked with the higher voltage rating. Substitutions can include better than series.

Part numbers marked in blue font are not recommended for new designs. Please use the T521 series instead.

^ Denotes the large reel (13") is not available.

* DF measurement condition is 120 Hz/0.5 V_{rms}/1.5 V DC Bias

(1) ESR frequency condition is 300 - 500 kHz

Refer to Ordering Information for additional detail.

Table 1 – Ratings & Part Number Reference cont.

| Rated Voltage VDC at 105°C | Rated Capacitance | Case Code/Case Size | KEMET Part Number | DC Leakage | DF | ESR | Maximum Allowable Ripple Current | Endurance | MSL | Maximum Operating Temperature | Derating Category |
|-------------------------------|-------------------|---------------------|------------------------------|------------------------------|--------------------------|----------------------------|----------------------------------|-----------|---------------------|-------------------------------|-------------------|
| Not all parts are 105°C rated | µF | KEMET/EIA | (See below for part options) | µA at 25°C Maximum/5 Minutes | % at 25°C 120 Hz Maximum | mΩ at 25°C 100 kHz Maximum | (rms) mA at +45°C 100 kHz | (Hours) | Reflow Temp ≤ 260°C | °C | |
| 6.3 | 100 | C/6032-28 | T520C107M006A(3)E025 | 63.0 | 8 | 25 | 2,600 | 2,000 | 3 | 105 | 3 |
| 6.3 | 100 | C/6032-28 | T520C107M006A(3)E045 | 63.0 | 8 | 45 | 1,900 | 2,000 | 3 | 105 | 3 |
| 6.3 | 120 | B/3528-20 | T520B127M006A(3)E035 | 75.6 | 8 | 35 | 1,900 | 2,000 | 3 | 105 | 3 |
| 6.3 | 150 | M/3528-15 | T520M157M006A(3)E035 | 94.5 | 8 | 35 | 1,850 | 2,000 | 3 | 105 | 3 |
| 6.3 | 150 | M/3528-15 | T520M157M006A(3)E070 | 94.5 | 8 | 70 | 1,310 | 2,000 | 3 | 105 | 3 |
| 6.3 | 150 | M/3528-15 | T520M157M006A(3)E150 | 94.5 | 8 | 150 | 900 | 2,000 | 3 | 105 | 3 |
| 6.3 | 150 | M/3528-15 | T520M157M006A(3)E200 | 94.5 | 8 | 200 | 800 | 2,000 | 3 | 105 | 3 |
| 6.3 | 150 | B/3528-20 | T520B157M006A(3)E018 | 94.5 | 9 | 18 | 2,700 | 2,000 | 3 | 105 | 3 |
| 6.3 | 150 | B/3528-20 | T520B157M006A(3)E025 | 94.5 | 8 | 25 | 2,300 | 2,000 | 3 | 105 | 3 |
| 6.3 | 150 | B/3528-20 | T520B157M006A(3)E035 | 94.5 | 8 | 35 | 1,900 | 2,000 | 3 | 105 | 3 |
| 6.3 | 150 | B/3528-20 | T520B157M006A(3)E045 | 94.5 | 8 | 45 | 1,700 | 2,000 | 3 | 105 | 3 |
| 6.3 | 150 | B/3528-20 | T520B157M006A(3)E070 | 94.5 | 8 | 70 | 1,300 | 2,000 | 3 | 105 | 3 |
| 6.3 | 150 | T/3528-12 | T523T157M006APE030 | 94.5 | 8 | 30 | 1,870 | 2,000 | 3 | 105 | 3 |
| 6.3 | 150 | T/3528-12 | T520T157M006ATE035 ^ | 94.5 | 8 * | 35 | 1,700 | 2,000 | 3 | 105 | 3 |
| 6.3 | 150 | C/6032-28 | T520C157M006A(3)E015 | 94.5 | 8 | 15 | 3,300 | 2,000 | 3 | 105 | 3 |
| 6.3 | 150 | C/6032-28 | T520C157M006A(3)E025 | 94.5 | 8 | 25 | 2,600 | 2,000 | 3 | 105 | 3 |
| 6.3 | 150 | C/6032-28 | T520C157M006A(3)E045 | 94.5 | 8 | 45 | 1,900 | 2,000 | 3 | 105 | 3 |
| 6.3 | 150 | C/6032-28 | T520C157M006A(3)E055 | 94.5 | 8 | 55 | 1,700 | 2,000 | 3 | 105 | 3 |
| 6.3 | 150 | U/6032-15 | T520U157M006A(3)E045 | 94.5 | 8 | 45 | 1,700 | 2,000 | 3 | 105 | 3 |
| 6.3 | 150 | U/6032-15 | T520U157M006A(3)E055 | 94.5 | 8 | 55 | 1,600 | 2,000 | 3 | 105 | 3 |
| 6.3 | 150 | L/6032-19 | T520L157M006A(3)E012 | 94.5 | 8 | 12 | 3,500 | 2,000 | 3 | 105 | 3 |
| 6.3 | 150 | L/6032-19 | T520L157M006A(3)E025 | 94.5 | 8 | 25 | 2,400 | 2,000 | 3 | 105 | 3 |
| 6.3 | 150 | W/7343-15 | T520W157M006A(3)E025 | 94.5 | 10 | 25 | 2,700 | 2,000 | 3 | 105 | 3 |
| 6.3 | 150 | W/7343-15 | T520W157M006A(3)E040 | 94.5 | 10 | 40 | 2,100 | 2,000 | 3 | 105 | 3 |
| 6.3 | 150 | V/7343-19 | T520V157M006A(3)E006 | 94.5 | 10 | 6 | 5,600 | 2,000 | 3 | 105 | 3 |
| 6.3 | 150 | V/7343-19 | T520V157M006A(3)E007 | 94.5 | 10 | 7 | 5,200 | 2,000 | 3 | 105 | 3 |
| 6.3 | 150 | V/7343-19 | T520V157M006A(3)E009 | 94.5 | 10 | 9 | 4,600 | 2,000 | 3 | 105 | 3 |
| 6.3 | 150 | V/7343-19 | T520V157M006A(3)E012 | 94.5 | 10 | 12 | 3,900 | 2,000 | 3 | 105 | 3 |
| 6.3 | 150 | V/7343-19 | T520V157M006A(3)E015 | 94.5 | 10 | 15 | 3,500 | 2,000 | 3 | 105 | 3 |
| 6.3 | 150 | V/7343-19 | T520V157M006A(3)E018 | 94.5 | 10 | 18 | 3,200 | 2,000 | 3 | 105 | 3 |
| 6.3 | 150 | V/7343-19 | T520V157M006A(3)E025 | 94.5 | 10 | 25 | 2,700 | 2,000 | 3 | 105 | 3 |
| 6.3 | 150 | V/7343-19 | T520V157M006A(3)E040 | 94.5 | 10 | 40 | 2,200 | 2,000 | 3 | 105 | 3 |
| 6.3 | 150 | V/7343-19 | T520V157M006A(3)E045 | 94.5 | 10 | 45 | 2,000 | 2,000 | 3 | 105 | 3 |
| 6.3 | 150 | D/7343-31 | T520D157M006A(3)E006 | 94.5 | 10 | 6 | 6,100 | 2,000 | 3 | 105 | 3 |
| 6.3 | 150 | D/7343-31 | T520D157M006A(3)E007 | 94.5 | 10 | 7 | 5,700 | 2,000 | 3 | 105 | 3 |
| 6.3 | 150 | D/7343-31 | T520D157M006A(3)E015 | 94.5 | 10 | 15 | 3,900 | 2,000 | 3 | 105 | 3 |
| 6.3 | 150 | D/7343-31 | T520D157M006A(3)E025 | 94.5 | 10 | 25 | 3,000 | 2,000 | 3 | 105 | 3 |
| 6.3 | 150 | D/7343-31 | T525D157M006A(3)E025 | 94.5 | 10 | 25 | 3,000 | 2,000 | 3 | 125 | 5 |
| 6.3 | 150 | D/7343-31 | T520D157M006A(3)E055 | 94.5 | 10 | 55 | 2,000 | 2,000 | 3 | 105 | 3 |
| 6.3 | 220 | M/3528-15 | T520M227M006ATE035 ^ | 138.6 | 10 * | 35 | 1,512 | 2,000 | 3 | 105 | 3 |
| 6.3 | 220 | B/3528-20 | T520B227M006A(3)E025 | 138.6 | 8 | 25 | 2,300 | 2,000 | 3 | 105 | 3 |
| VDC at 105°C | µF | KEMET/EIA | (See below for part options) | µA at 25°C Maximum/5 Minutes | % at 25°C 120 Hz Maximum | mΩ at 25°C 100 kHz Maximum | mA at +45°C 100 kHz | (Hours) | Reflow Temp ≤ 260°C | °C | |
| Rated Voltage | Rated Capacitance | Case Code/Case Size | KEMET Part Number | DC Leakage | DF | ESR | Maximum Allowable Ripple Current | Endurance | MSL | Maximum Operating Temp | Derating Category |

(2) To complete KEMET part number, insert M for ±20% or K for ±10%. Designates Capacitance tolerance.

(3) To complete KEMET part number, insert T = 100% Matte Tin (Sn)-plated or H = Standard Solder coated (SnPb 5% Pb minimum). Refer to Ordering Information for additional detail.

Higher voltage ratings and tighter ESR may be substituted within the same size at KEMET's option. Voltage substitutions will be marked with the higher voltage rating. Substitutions can include better than series.

Part numbers marked in blue font are not recommended for new designs. Please use the T521 series instead.

^ Denotes the large reel (13") is not available.

* DF measurement condition is 120 Hz/0.5 V_{rms}/1.5 V DC Bias

(1) ESR frequency condition is 300 - 500 kHz

Refer to Ordering Information for additional detail.

Table 1 – Ratings & Part Number Reference cont.

| Rated Voltage VDC at 105°C | Rated Capacitance | Case Code/Case Size | KEMET Part Number | DC Leakage | DF | ESR | Maximum Allowable Ripple Current | Endurance | MSL | Maximum Operating Temperature | Derating Category |
|-------------------------------|-------------------|---------------------|---------------------------------|------------------------------|--------------------------|----------------------------|----------------------------------|-----------|---------------------|-------------------------------|-------------------|
| Not all parts are 105°C rated | µF | KEMET/EIA | (See below for part options) | µA at 25°C Maximum/5 Minutes | % at 25°C 120 Hz Maximum | mΩ at 25°C 100 kHz Maximum | (rms) mA at +45°C 100 kHz | (Hours) | Reflow Temp ≤ 260°C | °C | |
| 6.3 | 220 | B/3528-20 | T520B227M006A(3)E035 | 138.6 | 8 | 35 | 1,900 | 2,000 | 3 | 105 | 3 |
| 6.3 | 220 | B/3528-20 | T520B227M006A(3)E045 | 138.6 | 8 | 45 | 1,700 | 2,000 | 3 | 105 | 3 |
| 6.3 | 220 | B/3528-20 | T520B227M006A(3)E070 | 138.6 | 8 | 70 | 1,300 | 2,000 | 3 | 105 | 3 |
| 6.3 | 220 | C/6032-28 | T520C227M006A(3)E015 | 138.6 | 8 | 15 | 3,300 | 2,000 | 3 | 105 | 3 |
| 6.3 | 220 | C/6032-28 | T520C227M006A(3)E018 | 138.6 | 8 | 18 | 3,000 | 2,000 | 3 | 105 | 3 |
| 6.3 | 220 | C/6032-28 | T520C227M006A(3)E025 | 138.6 | 8 | 25 | 2,600 | 2,000 | 3 | 105 | 3 |
| 6.3 | 220 | C/6032-28 | T520C227M006A(3)E045 | 138.6 | 8 | 45 | 1,900 | 2,000 | 3 | 105 | 3 |
| 6.3 | 220 | V/7343-19 | T520V227M006A(3)E007 | 138.6 | 10 | 7 | 5,200 | 2,000 | 3 | 105 | 3 |
| 6.3 | 220 | V/7343-19 | T520V227M006A(3)E009 | 138.6 | 10 | 9 | 4,600 | 2,000 | 3 | 105 | 3 |
| 6.3 | 220 | V/7343-19 | T520V227M006A(3)E012 | 138.6 | 10 | 12 | 3,900 | 2,000 | 3 | 105 | 3 |
| 6.3 | 220 | V/7343-19 | T520V227M006A(3)E015 | 138.6 | 10 | 15 | 3,500 | 2,000 | 3 | 105 | 3 |
| 6.3 | 220 | V/7343-19 | T520V227M006A(3)E018 | 138.6 | 10 | 18 | 3,200 | 2,000 | 3 | 105 | 3 |
| 6.3 | 220 | V/7343-19 | T520V227M006A(3)E025 | 138.6 | 10 | 25 | 2,700 | 2,000 | 3 | 105 | 3 |
| 6.3 | 220 | V/7343-19 | T520V227M006A(3)E040 | 138.6 | 10 | 40 | 2,200 | 2,000 | 3 | 105 | 3 |
| 6.3 | 220 | D/7343-31 | T530D227M006A(3)E005 | 138.6 | 8 | 5 | 7,100 | 2,000 | 3 | 125 | 5 |
| 6.3 | 220 | D/7343-31 | T520D227M006A(3)E006 | 138.6 | 10 | 6 | 6,100 | 2,000 | 3 | 105 | 3 |
| 6.3 | 220 | D/7343-31 | T530D227M006A(3)E006 | 138.6 | 8 | 6 | 6,500 | 2,000 | 3 | 125 | 5 |
| 6.3 | 220 | D/7343-31 | T520D227M006A(3)E007 | 138.6 | 10 | 7 | 5,700 | 2,000 | 3 | 105 | 3 |
| 6.3 | 220 | D/7343-31 | T520D227M006A(3)E009 | 138.6 | 10 | 9 | 5,000 | 2,000 | 3 | 105 | 3 |
| 6.3 | 220 | D/7343-31 | T520D227M006A(3)E015 | 138.6 | 10 | 15 | 3,900 | 2,000 | 3 | 105 | 3 |
| 6.3 | 220 | D/7343-31 | T520D227M006A(3)E018 | 138.6 | 10 | 18 | 3,500 | 2,000 | 3 | 105 | 3 |
| 6.3 | 220 | D/7343-31 | T520D227M006A(3)E025 | 138.6 | 10 | 25 | 3,000 | 2,000 | 3 | 105 | 3 |
| 6.3 | 220 | D/7343-31 | T525D227M006A(3)E025 | 138.6 | 10 | 25 | 3,000 | 2,000 | 3 | 125 | 5 |
| 6.3 | 220 | D/7343-31 | T520D227M006A(3)E040 | 138.6 | 10 | 40 | 2,400 | 2,000 | 3 | 105 | 3 |
| 6.3 | 220 | D/7343-31 | T520D227M006A(3)E050 | 138.6 | 10 | 50 | 2,100 | 2,000 | 3 | 105 | 3 |
| 6.3 | 330 | B/3528-20 | T520B337M006A(3)E040 | 207.9 | 8 | 40 | 1,800 | 2,000 | 3 | 105 | 3 |
| 6.3 | 330 | B/3528-20 | T520B337M006ATE045 ^A | 415.8 | 10 [*] | 45 | 1,374 | 2,000 | 3 | 85 | 1 |
| 6.3 | 330 | B/3528-20 | T520B337M006A(3)E070 | 207.9 | 8 | 70 | 1,350 | 2,000 | 3 | 105 | 3 |
| 6.3 | 330 | V/7343-19 | T520V337M006A(3)E015 | 207.9 | 10 | 15 | 3,500 | 2,000 | 3 | 105 | 3 |
| 6.3 | 330 | V/7343-19 | T520V337M006A(3)E018 | 207.9 | 10 | 18 | 3,200 | 2,000 | 3 | 105 | 3 |
| 6.3 | 330 | V/7343-19 | T520V337M006A(3)E025 | 207.9 | 10 | 25 | 2,700 | 2,000 | 3 | 105 | 3 |
| 6.3 | 330 | V/7343-19 | T520V337M006A(3)E040 | 207.9 | 10 | 40 | 2,200 | 2,000 | 3 | 105 | 3 |
| 6.3 | 330 | V/7343-19 | T520V337M006A(3)E045 | 207.9 | 10 | 45 | 2,000 | 2,000 | 3 | 105 | 3 |
| 6.3 | 330 | D/7343-31 | T530D337M006A(3)E006 | 207.9 | 8 | 6 | 6,500 | 2,000 | 3 | 125 | 5 |
| 6.3 | 330 | D/7343-31 | T520D337M006A(3)E009 | 207.9 | 10 | 9 | 5,000 | 2,000 | 3 | 105 | 3 |
| 6.3 | 330 | D/7343-31 | T520D337M006A(3)E010 | 207.9 | 10 | 10 | 4,700 | 2,000 | 3 | 105 | 3 |
| 6.3 | 330 | D/7343-31 | T530D337M006A(3)E010 | 207.9 | 8 | 10 | 5,000 | 2,000 | 3 | 125 | 5 |
| 6.3 | 330 | D/7343-31 | T520D337M006A(3)E015 | 207.9 | 10 | 15 | 3,900 | 2,000 | 3 | 105 | 3 |
| 6.3 | 330 | D/7343-31 | T520D337M006A(3)E018 | 207.9 | 10 | 18 | 3,500 | 2,000 | 3 | 105 | 3 |
| 6.3 | 330 | D/7343-31 | T520D337M006A(3)E025 | 207.9 | 10 | 25 | 3,000 | 2,000 | 3 | 105 | 3 |
| 6.3 | 330 | D/7343-31 | T525D337M006A(3)E025 | 207.9 | 10 | 25 | 3,000 | 2,000 | 3 | 125 | 5 |
| VDC at 105°C | µF | KEMET/EIA | (See below for part options) | µA at 25°C Maximum/5 Minutes | % at 25°C 120 Hz Maximum | mΩ at 25°C 100 kHz Maximum | mA at +45°C 100 kHz | (Hours) | Reflow Temp ≤ 260°C | °C | |
| Rated Voltage | Rated Capacitance | Case Code/Case Size | KEMET Part Number | DC Leakage | DF | ESR | Maximum Allowable Ripple Current | Endurance | MSL | Maximum Operating Temp | Derating Category |

(2) To complete KEMET part number, insert M for ±20% or K for ±10%. Designates Capacitance tolerance.

(3) To complete KEMET part number, insert T = 100% Matte Tin (Sn)-plated or H = Standard Solder coated (SnPb 5% Pb minimum). Refer to Ordering Information for additional detail.

Higher voltage ratings and tighter ESR may be substituted within the same size at KEMET's option. Voltage substitutions will be marked with the higher voltage rating. Substitutions can include better than series.

Part numbers marked in blue font are not recommended for new designs. Please use the T521 series instead.

^A Denotes the large reel (13") is not available.

^{*} DF measurement condition is 120 Hz/0.5 V_{rms}/1.5 V DC Bias

⁽¹⁾ ESR frequency condition is 300 - 500 kHz

Refer to Ordering Information for additional detail.

T52X/T530 Polymer Electrolytic Capacitors
KEMET Organic Capacitor (KO-CAP®)

Table 1 – Ratings & Part Number Reference cont.

| Rated Voltage VDC at 105°C | Rated Capacitance | Case Code/ Case Size | KEMET Part Number | DC Leakage | DF | ESR | Maximum Allowable Ripple Current | Endurance | MSL | Maximum Operating Temperature | Derating Category |
|-------------------------------|-------------------|----------------------|------------------------------|-------------------------------|--------------------------|----------------------------|----------------------------------|-----------|---------------------|-------------------------------|-------------------|
| Not all parts are 105°C rated | µF | KEMET/EIA | (See below for part options) | µA at 25°C Maximum/ 5 Minutes | % at 25°C 120 Hz Maximum | mΩ at 25°C 100 kHz Maximum | (rms) mA at +45°C 100 kHz | (Hours) | Reflow Temp ≤ 260°C | °C | |
| 6.3 | 330 | D/7343-31 | T520D337M006A(3)E040 | 207.9 | 10 | 40 | 2,400 | 2,000 | 3 | 105 | 3 |
| 6.3 | 330 | D/7343-31 | T525D337M006A(3)E040 | 207.9 | 10 | 40 | 2,400 | 2,000 | 3 | 125 | 5 |
| 6.3 | 330 | D/7343-31 | T520D337M006A(3)E045 | 207.9 | 10 | 45 | 2,200 | 2,000 | 3 | 105 | 3 |
| 6.3 | 330 | Y/7343-40 | T530Y337M006A(3)E005 | 207.9 | 8 | 5 | 7,300 | 2,000 | 3 | 125 | 5 |
| 6.3 | 330 | Y/7343-40 | T530Y337M006A(3)E006 | 207.9 | 8 | 6 | 6,600 | 2,000 | 3 | 125 | 5 |
| 6.3 | 330 | Y/7343-40 | T520Y337M006A(3)E010 | 207.9 | 10 | 10 | 4,900 | 2,000 | 3 | 105 | 3 |
| 6.3 | 330 | Y/7343-40 | T530Y337M006A(3)E010 | 207.9 | 8 | 10 | 5,100 | 2,000 | 3 | 125 | 5 |
| 6.3 | 330 | Y/7343-40 | T520Y337M006A(3)E015 | 207.9 | 10 | 15 | 4,000 | 2,000 | 3 | 105 | 3 |
| 6.3 | 330 | Y/7343-40 | T520Y337M006A(3)E025 | 207.9 | 10 | 25 | 3,100 | 2,000 | 3 | 105 | 3 |
| 6.3 | 330 | Y/7343-40 | T520Y337M006A(3)E040 | 207.9 | 10 | 40 | 2,500 | 2,000 | 3 | 105 | 3 |
| 6.3 | 470 | W/7343-15 | T520W477M006A(3)E055 | 296.1 | 10 | 55 | 1,800 | 2,000 | 3 | 85 | 1 |
| 6.3 | 470 | W/7343-15 | T520W477M006A(3)E035 | 296.1 | 9 | 35 | 2,300 | 2,000 | 3 | 85 | 1 |
| 6.3 | 470 | V/7343-19 | T520V477M006A(3)E055 | 296.1 | 10 | 55 | 1,800 | 2,000 | 3 | 105 | 3 |
| 6.3 | 470 | V/7343-19 | T520V477M006A(3)E035 | 296.1 | 10 | 35 | 2,300 | 2,000 | 3 | 105 | 3 |
| 6.3 | 470 | Y/7343-40 | T530Y477M006A(3)E005 | 296.1 | 8 | 5 | 7,300 | 2,000 | 3 | 125 | 5 |
| 6.3 | 470 | Y/7343-40 | T520Y477M006A(3)E010 | 296.1 | 10 | 10 | 4,900 | 2,000 | 3 | 105 | 3 |
| 6.3 | 470 | Y/7343-40 | T520Y477M006A(3)E015 | 296.1 | 10 | 15 | 4,000 | 2,000 | 3 | 105 | 3 |
| 6.3 | 470 | Y/7343-40 | T520Y477M006A(3)E018 | 296.1 | 10 | 18 | 3,700 | 2,000 | 3 | 105 | 3 |
| 6.3 | 470 | Y/7343-40 | T520Y477M006A(3)E025 | 296.1 | 10 | 25 | 3,100 | 2,000 | 3 | 105 | 3 |
| 6.3 | 470 | Y/7343-40 | T520Y477M006A(3)E035 | 296.1 | 10 | 35 | 2,600 | 2,000 | 3 | 105 | 3 |
| 6.3 | 470 | Y/7343-40 | T525Y477M006A(3)E035 | 296.1 | 10 | 35 | 2,600 | 2,000 | 3 | 125 | 5 |
| 6.3 | 470 | D/7343-31 | T520D477M006A(3)E015 | 296.1 | 10 | 15 | 3,900 | 2,000 | 3 | 105 | 3 |
| 6.3 | 470 | D/7343-31 | T520D477(2)006A(3)E025 | 296.1 | 10 | 25 | 3,000 | 2,000 | 3 | 105 | 3 |
| 6.3 | 470 | D/7343-31 | T520D477M006A(3)E030 | 296.1 | 10 | 30 | 2,700 | 2,000 | 3 | 105 | 3 |
| 6.3 | 470 | X/7343-43 | T530X477M006A(3)E004 | 296.1 | 8 | 4 | 8,200 | 2,000 | 3 | 125 | 5 |
| 6.3 | 470 | X/7343-43 | T530X477M006A(3)E005 | 296.1 | 8 | 5 | 7,300 | 2,000 | 3 | 125 | 5 |
| 6.3 | 470 | X/7343-43 | T530X477M006A(3)E006 | 296.1 | 8 | 6 | 6,700 | 2,000 | 3 | 125 | 5 |
| 6.3 | 470 | X/7343-43 | T520X477M006A(3)E010 | 296.1 | 10 | 10 | 5,000 | 2,000 | 3 | 105 | 3 |
| 6.3 | 470 | X/7343-43 | T530X477M006A(3)E010 | 296.1 | 8 | 10 | 5,200 | 2,000 | 3 | 125 | 5 |
| 6.3 | 470 | X/7343-43 | T520X477M006A(3)E018 | 296.1 | 10 | 18 | 3,700 | 2,000 | 3 | 105 | 3 |
| 6.3 | 470 | X/7343-43 | T520X477M006A(3)E035 | 296.1 | 10 | 35 | 2,700 | 2,000 | 3 | 105 | 3 |
| 6.3 | 470 | X/7343-43 | T520X477M006A(3)E040 | 296.1 | 10 | 40 | 2,500 | 2,000 | 3 | 105 | 3 |
| 6.3 | 680 | V/7343-19 | T520V687M006A(3)E025 | 428.4 | 10 | 25 | 2,730 | 2,000 | 3 | 105 | 3 |
| 6.3 | 680 | V/7343-19 | T520V687M006A(3)E035 | 428.4 | 10 | 35 | 2,300 | 2,000 | 3 | 105 | 3 |
| 6.3 | 680 | Y/7343-40 | T520Y687M006A(3)E018 | 428.4 | 10 | 18 | 3,700 | 2,000 | 3 | 105 | 3 |
| 6.3 | 680 | Y/7343-40 | T520Y687M006A(3)E025 | 428.4 | 10 | 25 | 3,100 | 2,000 | 3 | 105 | 3 |
| 6.3 | 680 | X/7343-43 | T530X687M006A(3)E010 | 428.4 | 8 | 10 | 5,200 | 2,000 | 3 | 125 | 5 |
| 6.3 | 680 | X/7343-43 | T530X687M006A(3)E018 | 428.4 | 8 | 18 | 3,900 | 2,000 | 3 | 125 | 5 |
| 6.3 | 680 | X/7343-43 | T520X687M006A(3)E025 | 428.4 | 10 | 25 | 3,100 | 2,000 | 3 | 105 | 3 |
| 6.3 | 680 | X/7343-43 | T520X687M006A(3)E018 | 428.0 | 10 | 18 | 3,700 | 2,000 | 3 | 105 | 3 |
| 6.3 | 680 | J/7360-15 | T523J687M006APE070 | 428.0 | 10 | 70 | 2,510 | 2,000 | 3 | 85 | 1 |
| VDC at 105°C | µF | KEMET/EIA | (See below for part options) | µA at 25°C Maximum/ 5 Minutes | % at 25°C 120 Hz Maximum | mΩ at 25°C 100 kHz Maximum | mA at +45°C 100 kHz | (Hours) | Reflow Temp ≤ 260°C | °C | |
| Rated Voltage | Rated Capacitance | Case Code/ Case Size | KEMET Part Number | DC Leakage | DF | ESR | Maximum Allowable Ripple Current | Endurance | MSL | Maximum Operating Temp | Derating Category |

(2) To complete KEMET part number, insert M for ±20% or K for ±10%. Designates Capacitance tolerance.

(3) To complete KEMET part number, insert T = 100% Matte Tin (Sn)-plated or H = Standard Solder coated (SnPb 5% Pb minimum). Refer to Ordering Information for additional detail.

Higher voltage ratings and tighter ESR may be substituted within the same size at KEMET's option. Voltage substitutions will be marked with the higher voltage rating. Substitutions can include better than series.

Part numbers marked in blue font are not recommended for new designs. Please use the T521 series instead.

^ Denotes the large reel (13") is not available.

* DF measurement condition is 120 Hz/0.5 V_{rms}/1.5 V DC Bias

(1) ESR frequency condition is 300 - 500 kHz

Refer to Ordering Information for additional detail.

T52X/T530 Polymer Electrolytic Capacitors
KEMET Organic Capacitor (KO-CAP®)

Table 1 – Ratings & Part Number Reference cont.

| Rated Voltage VDC at 105°C | Rated Capacitance | Case Code/Case Size | KEMET Part Number | DC Leakage | DF | ESR | Maximum Allowable Ripple Current | Endurance | MSL | Maximum Operating Temperature | Derating Category |
|-------------------------------|-------------------|---------------------|------------------------------|------------------------------|--------------------------|----------------------------|----------------------------------|-----------|---------------------|-------------------------------|-------------------|
| Not all parts are 105°C rated | µF | KEMET/EIA | (See below for part options) | µA at 25°C Maximum/5 Minutes | % at 25°C 120 Hz Maximum | mΩ at 25°C 100 kHz Maximum | (rms) mA at +45°C 100 kHz | (Hours) | Reflow Temp ≤ 260°C | °C | |
| 6.3 | 1000 | H/7360-20 | T520H108M006A(3)E055 | 630.0 | 20 | 55 | 1,800 | 2,000 | 3 | 85 | 1 |
| 6.3 | 1200 | H/7360-20 | T520H128M006A(3)E070 | 756.0 | 20 | 70 | 1,630 | 2,000 | 3 | 85 | 1 |
| 6.3 | 1500 | H/7360-20 | T520H158M006A(3)E055 | 945.0 | 20 | 55 | 1,800 | 2,000 | 3 | 85 | 1 |
| 8 | 22 | T/3528-12 | T520T226M008A(3)E070 | 17.6 | 8 | 70 | 1,220 | 2,000 | 3 | 105 | 3 |
| 8 | 33 | T/3528-12 | T520T336M008A(3)E070 | 26.4 | 8 | 70 | 1,220 | 2,000 | 3 | 105 | 3 |
| 8 | 33 | T/3528-12 | T520T336M008A(3)E080 | 26.4 | 8 | 80 | 1,100 | 2,000 | 3 | 105 | 3 |
| 8 | 33 | T/3528-12 | T525T336M008A(3)E080 | 26.4 | 8 | 80 | 1,100 | 2,000 | 3 | 125 | 5 |
| 8 | 33 | B/3528-20 | T520B336M008A(3)E025 | 26.4 | 8 | 25 | 2,300 | 2,000 | 3 | 105 | 3 |
| 8 | 33 | B/3528-20 | T520B336M008A(3)E035 | 26.4 | 8 | 35 | 1,900 | 2,000 | 3 | 105 | 3 |
| 8 | 33 | B/3528-20 | T520B336M008A(3)E040 | 26.4 | 8 | 40 | 1,800 | 2,000 | 3 | 105 | 3 |
| 8 | 33 | B/3528-20 | T520B336M008A(3)E070 | 26.4 | 8 | 70 | 1,350 | 2,000 | 3 | 105 | 3 |
| 8 | 33 | U/6032-15 | T520U336M008A(3)E070 | 26.4 | 8 | 70 | 1,400 | 2,000 | 3 | 105 | 3 |
| 8 | 47 | B/3528-20 | T520B476M008A(3)E035 | 37.6 | 8 | 35 | 1,900 | 2,000 | 3 | 105 | 3 |
| 8 | 47 | B/3528-20 | T520B476M008A(3)E070 | 37.6 | 8 | 70 | 1,350 | 2,000 | 3 | 105 | 3 |
| 8 | 82 | C/6032-28 | T520C826M008A(3)E025 | 65.6 | 8 | 25 | 2,600 | 2,000 | 3 | 105 | 3 |
| 8 | 82 | C/6032-28 | T520C826M008A(3)E045 | 65.6 | 8 | 45 | 1,900 | 2,000 | 3 | 105 | 3 |
| 8 | 150 | D/7343-31 | T520D157M008A(3)E025 | 120 | 10 | 25 | 3,000 | 2,000 | 3 | 105 | 3 |
| 8 | 150 | D/7343-31 | T520D157M008A(3)E040 | 120 | 10 | 40 | 2,400 | 2,000 | 3 | 105 | 3 |
| 8 | 150 | D/7343-31 | T520D157M008A(3)E055 | 120 | 10 | 55 | 2,000 | 2,000 | 3 | 105 | 3 |
| 8 | 150 | V/7343-19 | T520V157M008A(3)E040 | 120 | 10 | 40 | 2,200 | 2,000 | 3 | 105 | 3 |
| 10 | 10 | P/2012-10 | T529P106M010AAE200 ^ | 30 | 6 * | 200 | 354 | 1,000 | 3 | 105 | 3 |
| 10 | 10 | A/3216-18 | T520A106M010A(3)E080 ^ | 10 | 8 * | 80 | 1,200 | 2,000 | 3 | 105 | 3 |
| 10 | 10 | A/3216-18 | T525A106M010A(3)E080 | 10 | 8 | 80 | 1,200 | 2,000 | 3 | 125 | 5 |
| 10 | 15 | A/3216-18 | T520A156M010ATE080 ^ | 15 | 8 * | 80 | 1,200 | 2,000 | 3 | 105 | 3 |
| 10 | 22 | P/2012-10 | T529P226M010AAE150 ^ | 66 | 6 * | 150 | 408 | 1,000 | 3 | 105 | 3 |
| 10 | 22 | P/2012-10 | T529P226M010AAE200 ^ | 66 | 6 * | 200 | 354 | 1,000 | 3 | 105 | 3 |
| 10 | 22 | I/3216-10 | T527I226M010ATE200 ^ | 22 | 8 * | 200 | 548 | 1,000 | 3 | 105 | 3 |
| 10 | 22 | A/3216-18 | T520A226M010A(3)E080 ^ | 22 | 8 * | 80 | 1,200 | 2,000 | 3 | 105 | 3 |
| 10 | 22 | B/3528-20 | T525B226M010A(3)E080 | 22 | 8 | 80 | 1,300 | 2,000 | 3 | 125 | 5 |
| 10 | 33 | I/3216-10 | T527I336M010ATE200 ^ | 33 | 6 * | 200 | 548 | 1,000 | 3 | 105 | 3 |
| 10 | 33 | T/3528-12 | T520T336M010A(3)E040 | 33 | 8 | 40 | 1,600 | 2,000 | 3 | 105 | 3 |
| 10 | 33 | T/3528-12 | T520T336M010A(3)E070 | 33 | 8 | 70 | 1,220 | 2,000 | 3 | 105 | 3 |
| 10 | 33 | T/3528-12 | T520T336M010A(3)E080 | 33 | 8 | 80 | 1,100 | 2,000 | 3 | 105 | 3 |
| 10 | 33 | T/3528-12 | T525T336M010A(3)E080 | 33 | 8 | 80 | 1,100 | 2,000 | 3 | 125 | 5 |
| 10 | 33 | B/3528-20 | T520B336M010A(3)E025 | 33 | 8 | 25 | 2,300 | 2,000 | 3 | 105 | 3 |
| 10 | 33 | B/3528-20 | T520B336M010A(3)E035 | 33 | 8 | 35 | 1,900 | 2,000 | 3 | 105 | 3 |
| 10 | 33 | B/3528-20 | T520B336M010A(3)E040 | 33 | 8 | 40 | 1,800 | 2,000 | 3 | 105 | 3 |
| 10 | 33 | B/3528-20 | T520B336M010A(3)E070 | 33 | 8 | 70 | 1,350 | 2,000 | 3 | 105 | 3 |
| 10 | 33 | B/3528-20 | T525B336M010A(3)E080 | 33 | 8 | 80 | 1,300 | 2,000 | 3 | 125 | 5 |
| 10 | 33 | U/6032-15 | T520U336M010A(3)E070 | 33 | 8 | 70 | 1,400 | 2,000 | 3 | 105 | 3 |
| 10 | 47 | I/3216-10 | T527I476M010ATE200 ^ | 47 | 6 * | 200 | 548 | 1,000 | 3 | 105 | 3 |
| VDC at 105°C | µF | KEMET/EIA | (See below for part options) | µA at 25°C Maximum/5 Minutes | % at 25°C 120 Hz Maximum | mΩ at 25°C 100 kHz Maximum | mA at +45°C 100 kHz | (Hours) | Reflow Temp ≤ 260°C | °C | |
| Rated Voltage | Rated Capacitance | Case Code/Case Size | KEMET Part Number | DC Leakage | DF | ESR | Maximum Allowable Ripple Current | Endurance | MSL | Maximum Operating Temp | Derating Category |

(2) To complete KEMET part number, insert M for ±20% or K for ±10%. Designates Capacitance tolerance.

(3) To complete KEMET part number, insert T = 100% Matte Tin (Sn)-plated or H = Standard Solder coated (SnPb 5% Pb minimum). Refer to Ordering Information for additional detail.

Higher voltage ratings and tighter ESR may be substituted within the same size at KEMET's option. Voltage substitutions will be marked with the higher voltage rating. Substitutions can include better than series.

Part numbers marked in blue font are not recommended for new designs. Please use the T521 series instead.

^ Denotes the large reel (13") is not available.

* DF measurement condition is 120 Hz/0.5 V_{rms}/1.5 V DC Bias

(1) ESR frequency condition is 300 - 500 kHz

Refer to Ordering Information for additional detail.

Table 1 – Ratings & Part Number Reference cont.

| Rated Voltage VDC at 105°C | Rated Capacitance | Case Code/ Case Size | KEMET Part Number | DC Leakage | DF | ESR | Maximum Allowable Ripple Current | Endurance | MSL | Maximum Operating Temperature | Derating Category |
|-------------------------------|-------------------|----------------------|------------------------------|-------------------------------|--------------------------|----------------------------|----------------------------------|-----------|---------------------|-------------------------------|-------------------|
| Not all parts are 105°C rated | µF | KEMET/EIA | (See below for part options) | µA at 25°C Maximum/ 5 Minutes | % at 25°C 120 Hz Maximum | mΩ at 25°C 100 kHz Maximum | (rms) mA at +45°C 100 kHz | (Hours) | Reflow Temp ≤ 260°C | °C | |
| 10 | 47 | A/3216-18 | T520A476M010ATE045 ^ | 47 | 8 * | 45 | 1,291 | 2,000 | 3 | 105 | 3 |
| 10 | 47 | B/3528-20 | T520B476M010A(3)E035 | 47 | 8 | 35 | 1,900 | 2,000 | 3 | 105 | 3 |
| 10 | 47 | B/3528-20 | T520B476M010A(3)E070 | 47 | 8 | 70 | 1,350 | 2,000 | 3 | 105 | 3 |
| 10 | 47 | U/6032-15 | T520U476M010A(3)E055 | 47 | 8 | 55 | 1,600 | 2,000 | 3 | 105 | 3 |
| 10 | 47 | C/6032-28 | T520C476M010A(3)E100 | 47 | 8 | 100 | 1,300 | 2,000 | 3 | 105 | 3 |
| 10 | 68 | U/6032-15 | T520U686M010A(3)E055 | 68 | 8 | 55 | 1,600 | 2,000 | 3 | 105 | 3 |
| 10 | 68 | W/7343-15 | T520W686M010A(3)E025 | 68 | 10 | 25 | 2,700 | 2,000 | 3 | 105 | 3 |
| 10 | 68 | W/7343-15 | T520W686M010A(3)E040 | 68 | 10 | 40 | 2,100 | 2,000 | 3 | 105 | 3 |
| 10 | 68 | C/6032-28 | T520C686M010A(3)E045 | 68 | 8 | 45 | 1,900 | 2,000 | 3 | 105 | 3 |
| 10 | 68 | V/7343-19 | T520V686M010A(3)E025 | 68 | 10 | 25 | 2,700 | 2,000 | 3 | 105 | 3 |
| 10 | 68 | V/7343-19 | T520V686M010A(3)E040 | 68 | 10 | 40 | 2,200 | 2,000 | 3 | 105 | 3 |
| 10 | 68 | V/7343-19 | T520V686M010A(3)E045 | 68 | 10 | 45 | 2,000 | 2,000 | 3 | 105 | 3 |
| 10 | 68 | V/7343-19 | T520V686M010A(3)E060 | 68 | 10 | 60 | 1,800 | 2,000 | 3 | 105 | 3 |
| 10 | 68 | V/7343-19 | T520V686M010A(3)E100 | 68 | 10 | 100 | 1,400 | 2,000 | 3 | 105 | 3 |
| 10 | 68 | D/7343-31 | T520D686M010A(3)E100 | 68 | 10 | 100 | 1,500 | 2,000 | 3 | 105 | 3 |
| 10 | 100 | B/3528-20 | T520B107M010ATE070 ^ | 100 | 8 * | 70 | 1,300 | 2,000 | 3 | 105 | 3 |
| 10 | 100 | C/6032-28 | T520C107M010A(3)E025 | 100 | 8 | 25 | 2,600 | 2,000 | 3 | 105 | 3 |
| 10 | 100 | C/6032-28 | T520C107M010A(3)E045 | 100 | 8 | 45 | 1,900 | 2,000 | 3 | 105 | 3 |
| 10 | 100 | L/6032-19 | T520L107M010A(3)E025 | 100 | 8 | 25 | 2,400 | 2,000 | 3 | 105 | 3 |
| 10 | 100 | W/7343-15 | T520W107M010A(3)E040 | 100 | 10 | 40 | 2,100 | 2,000 | 3 | 105 | 3 |
| 10 | 100 | V/7343-19 | T520V107M010A(3)E018 | 100 | 10 | 18 | 3,200 | 2,000 | 3 | 105 | 3 |
| 10 | 100 | V/7343-19 | T520V107M010A(3)E025 | 100 | 10 | 25 | 2,700 | 2,000 | 3 | 105 | 3 |
| 10 | 100 | V/7343-19 | T520V107M010A(3)E045 | 100 | 10 | 45 | 2,000 | 2,000 | 3 | 105 | 3 |
| 10 | 100 | V/7343-19 | T520V107M010A(3)E050 | 100 | 10 | 50 | 1,900 | 2,000 | 3 | 105 | 3 |
| 10 | 100 | V/7343-19 | T520V107M010A(3)E055 | 100 | 10 | 55 | 1,800 | 2,000 | 3 | 105 | 3 |
| 10 | 100 | D/7343-31 | T520D107M010A(3)E018 | 100 | 10 | 18 | 3,500 | 2,000 | 3 | 105 | 3 |
| 10 | 100 | D/7343-31 | T525D107M010A(3)E025 | 100 | 10 | 25 | 3,000 | 2,000 | 3 | 125 | 5 |
| 10 | 100 | D/7343-31 | T520D107M010A(3)E055 | 100 | 10 | 55 | 2,000 | 2,000 | 3 | 105 | 3 |
| 10 | 100 | D/7343-31 | T520D107M010A(3)E080 | 100 | 10 | 80 | 1,700 | 2,000 | 3 | 105 | 3 |
| 10 | 150 | C/6032-28 | T520C157M010A(3)E055 | 150 | 8 | 55 | 1,700 | 2,000 | 3 | 105 | 3 |
| 10 | 150 | V/7343-19 | T520V157M010A(3)E018 | 150 | 10 | 18 | 3,200 | 2,000 | 3 | 105 | 3 |
| 10 | 150 | V/7343-19 | T520V157M010A(3)E025 | 150 | 10 | 25 | 2,700 | 2,000 | 3 | 105 | 3 |
| 10 | 150 | V/7343-19 | T520V157M010A(3)E040 | 150 | 10 | 40 | 2,200 | 2,000 | 3 | 105 | 3 |
| 10 | 150 | D/7343-31 | T530D157M010A(3)E005 | 150 | 8 | 5 | 7,100 | 2,000 | 3 | 125 | 5 |
| 10 | 150 | D/7343-31 | T530D157M010A(3)E006 | 150 | 8 | 6 | 6,500 | 2,000 | 3 | 125 | 5 |
| 10 | 150 | D/7343-31 | T530D157M010A(3)E010 | 150 | 8 | 10 | 5,000 | 2,000 | 3 | 125 | 5 |
| 10 | 150 | D/7343-31 | T520D157M010A(3)E015 | 150 | 10 | 15 | 3,900 | 2,000 | 3 | 105 | 3 |
| 10 | 150 | D/7343-31 | T520D157M010A(3)E018 | 150 | 10 | 18 | 3,500 | 2,000 | 3 | 105 | 3 |
| 10 | 150 | D/7343-31 | T520D157M010A(3)E025 | 150 | 10 | 25 | 3,000 | 2,000 | 3 | 105 | 3 |
| 10 | 150 | D/7343-31 | T525D157M010A(3)E025 | 150 | 10 | 25 | 3,000 | 2,000 | 3 | 125 | 5 |
| VDC at 105°C | µF | KEMET/EIA | (See below for part options) | µA at 25°C Maximum/ 5 Minutes | % at 25°C 120 Hz Maximum | mΩ at 25°C 100 kHz Maximum | mA at +45°C 100 kHz | (Hours) | Reflow Temp ≤ 260°C | °C | |
| Rated Voltage | Rated Capacitance | Case Code/ Case Size | KEMET Part Number | DC Leakage | DF | ESR | Maximum Allowable Ripple Current | Endurance | MSL | Maximum Operating Temp | Derating Category |

(2) To complete KEMET part number, insert M for ±20% or K for ±10%. Designates Capacitance tolerance.

(3) To complete KEMET part number, insert T = 100% Matte Tin (Sn)-plated or H = Standard Solder coated (SnPb 5% Pb minimum). Refer to Ordering Information for additional detail.

Higher voltage ratings and tighter ESR may be substituted within the same size at KEMET's option. Voltage substitutions will be marked with the higher voltage rating. Substitutions can include better than series.

Part numbers marked in blue font are not recommended for new designs. Please use the T521 series instead.

^ Denotes the large reel (13") is not available.

* DF measurement condition is 120 Hz/0.5 V_{rms}/1.5 V DC Bias

(1) ESR frequency condition is 300 - 500 kHz

Refer to Ordering Information for additional detail.

T52X/T530 Polymer Electrolytic Capacitors
KEMET Organic Capacitor (KO-CAP®)

Table 1 – Ratings & Part Number Reference cont.

| Rated Voltage VDC at 105°C | Rated Capacitance | Case Code/Case Size | KEMET Part Number | DC Leakage | DF | ESR | Maximum Allowable Ripple Current | Endurance | MSL | Maximum Operating Temperature | Derating Category |
|-------------------------------|-------------------|---------------------|------------------------------|-------------------------------|--------------------------|----------------------------|----------------------------------|-----------|---------------------|-------------------------------|-------------------|
| Not all parts are 105°C rated | µF | KEMET/EIA | (See below for part options) | µA at 25°C Maximum/ 5 Minutes | % at 25°C 120 Hz Maximum | mΩ at 25°C 100 kHz Maximum | (rms) mA at +45°C 100 kHz | (Hours) | Reflow Temp ≤ 260°C | °C | |
| 10 | 150 | D/7343-31 | T520D157M010A(3)E040 | 150 | 10 | 40 | 2,400 | 2,000 | 3 | 105 | 3 |
| 10 | 150 | D/7343-31 | T520D157M010A(3)E055 | 150 | 10 | 55 | 2,000 | 2,000 | 3 | 105 | 3 |
| 10 | 150 | D/7343-31 | T525D157M010A(3)E055 | 150 | 10 | 55 | 2,000 | 2,000 | 3 | 125 | 5 |
| 10 | 150 | Y/7343-40 | T520Y157M010A(3)E015 | 150 | 10 | 15 | 4,000 | 2,000 | 3 | 105 | 3 |
| 10 | 150 | Y/7343-40 | T520Y157M010A(3)E018 | 150 | 10 | 18 | 3,700 | 2,000 | 3 | 105 | 3 |
| 10 | 150 | Y/7343-40 | T520Y157M010A(3)E025 | 150 | 10 | 25 | 3,100 | 2,000 | 3 | 105 | 3 |
| 10 | 220 | V/7343-19 | T520V227M010A(3)E040 | 220 | 10 | 40 | 2,200 | 2,000 | 3 | 105 | 3 |
| 10 | 220 | V/7343-19 | T520V227M010A(3)E045 | 220 | 10 | 45 | 2,000 | 2,000 | 3 | 105 | 3 |
| 10 | 220 | V/7343-19 | T520V227M010A(3)E025 | 220 | 10 | 25 | 2,700 | 2,000 | 3 | 105 | 3 |
| 10 | 220 | D/7343-31 | T530D227M010A(3)E006 | 220 | 8 | 6 | 6,500 | 2,000 | 3 | 125 | 5 |
| 10 | 220 | D/7343-31 | T530D227M010A(3)E010 | 220 | 8 | 10 | 5,000 | 2,000 | 3 | 125 | 5 |
| 10 | 220 | D/7343-31 | T520D227M010A(3)E018 | 220 | 10 | 18 | 3,500 | 2,000 | 3 | 105 | 3 |
| 10 | 220 | D/7343-31 | T520D227M010A(3)E025 | 220 | 10 | 25 | 3,000 | 2,000 | 3 | 105 | 3 |
| 10 | 220 | D/7343-31 | T525D227M010A(3)E025 | 220 | 10 | 25 | 3,000 | 2,000 | 3 | 125 | 5 |
| 10 | 220 | D/7343-31 | T520D227M010A(3)E040 | 220 | 10 | 40 | 2,400 | 2,000 | 3 | 105 | 3 |
| 10 | 220 | Y/7343-40 | T530Y227M010A(3)E006 | 220 | 8 | 6 | 6,600 | 2,000 | 3 | 125 | 5 |
| 10 | 220 | Y/7343-40 | T520Y227M010A(3)E040 | 220 | 10 | 40 | 2,500 | 2,000 | 3 | 105 | 3 |
| 10 | 330 | Y/7343-40 | T520Y337M010A(3)E015 | 330 | 10 | 15 | 4,000 | 2,000 | 3 | 105 | 3 |
| 10 | 330 | Y/7343-40 | T520Y337M010A(3)E025 | 330 | 10 | 25 | 3,100 | 2,000 | 3 | 105 | 3 |
| 10 | 330 | Y/7343-40 | T520Y337M010A(3)E035 | 330 | 10 | 35 | 2,600 | 2,000 | 3 | 105 | 3 |
| 10 | 330 | Y/7343-40 | T525Y337M010A(3)E025 | 330 | 10 | 25 | 3,100 | 2,000 | 3 | 125 | 5 |
| 10 | 330 | Y/7343-40 | T525Y337M010A(3)E035 | 330 | 10 | 35 | 2,600 | 2,000 | 3 | 125 | 5 |
| 10 | 330 | X/7343-43 | T530X337M010A(3)E004 | 330 | 8 | 4 | 8,200 | 2,000 | 3 | 125 | 5 |
| 10 | 330 | X/7343-43 | T530X337M010A(3)E005 | 330 | 8 | 5 | 7,300 | 2,000 | 3 | 125 | 5 |
| 10 | 330 | X/7343-43 | T530X337M010A(3)E006 | 330 | 8 | 6 | 6,700 | 2,000 | 3 | 125 | 5 |
| 10 | 330 | X/7343-43 | T520X337M010A(3)E010 | 330 | 10 | 10 | 5,000 | 2,000 | 3 | 105 | 3 |
| 10 | 330 | X/7343-43 | T530X337M010A(3)E010 | 330 | 8 | 10 | 5,200 | 2,000 | 3 | 125 | 5 |
| 10 | 330 | X/7343-43 | T520X337M010A(3)E025 | 330 | 10 | 25 | 3,100 | 2,000 | 3 | 105 | 3 |
| 10 | 330 | X/7343-43 | T520X337M010A(3)E035 | 330 | 10 | 35 | 2,700 | 2,000 | 3 | 105 | 3 |
| 10 | 330 | J/7360-15 | T523J337M010APE070 | 330 | 10 | 70 | 2,510 | 2,000 | 3 | 85 | 1 |
| 10 | 470 | X/7343-43 | T530X477M010A(3)E020 | 470 | 10 | 20 | 3,670 | 2,000 | 3 | 125 | 5 |
| 10 | 470 | J/7360-15 | T523J477M010APE070 | 470 | 10 | 70 | 2,510 | 2,000 | 3 | 85 | 1 |
| 10 | 820 | H/7360-20 | T520H827M010A(3)E070 | 820 | 20 | 70 | 1,630 | 2,000 | 3 | 85 | 1 |
| 10 | 330 | X/7343-43 | T520X337M010A(3)E040 | 330 | 10 | 40 | 2,500 | 2,000 | 3 | 105 | 3 |
| 11 | 47 | Q/7343-12 | T520Q476M011A(3)E040 | 52 | 10 | 40 | 2,060 | 2,000 | 3 | 105 | 4 |
| 12.5 | 10 | T/3528-12 | T520T106M12RA(3)E080 | 12.5 | 8 | 80 | 1,100 | 2,000 | 3 | 105 | 4 |
| 12.5 | 10 | T/3528-12 | T520T106M12RA(3)E150 | 12.5 | 8 | 150 | 800 | 2,000 | 3 | 105 | 4 |
| 12.5 | 15 | T/3528-12 | T520T156M12RA(3)E080 | 18.75 | 8 | 80 | 1,100 | 2,000 | 3 | 105 | 4 |
| 12.5 | 47 | T/3528-12 | T521T476M12RA(3)E090 | 58.8 | 8 | 90 | 1,330 | 2,000 | 3 | 105 | 4 |
| 16 | 10 | P/2012-10 | T529P106M016AAE150 ^ | 80 | 6 * | 150 | 408 | 1,000 | 3 | 105 | 4 |
| 16 | 10 | A/3216-18 | T521A106M016ATE200 ^ | 16 | 8 * | 200 | 612 | 2,000 | 3 | 105 | 4 |
| VDC at 105°C | µF | KEMET/EIA | (See below for part options) | µA at 25°C Maximum/ 5 Minutes | % at 25°C 120 Hz Maximum | mΩ at 25°C 100 kHz Maximum | mA at +45°C 100 kHz | (Hours) | Reflow Temp ≤ 260°C | °C | |
| Rated Voltage | Rated Capacitance | Case Code/Case Size | KEMET Part Number | DC Leakage | DF | ESR | Maximum Allowable Ripple Current | Endurance | MSL | Maximum Operating Temp | Derating Category |

(2) To complete KEMET part number, insert M for ±20% or K for ±10%. Designates Capacitance tolerance.

(3) To complete KEMET part number, insert T = 100% Matte Tin (Sn)-plated or H = Standard Solder coated (SnPb 5% Pb minimum). Refer to Ordering Information for additional detail.

Higher voltage ratings and tighter ESR may be substituted within the same size at KEMET's option. Voltage substitutions will be marked with the higher voltage rating. Substitutions can include better than series.

Part numbers marked in blue font are not recommended for new designs. Please use the T521 series instead.

^ Denotes the large reel (13") is not available.

* DF measurement condition is 120 Hz/0.5 V_{rms}/1.5 V DC Bias

(1) ESR frequency condition is 300 - 500 kHz

Refer to Ordering Information for additional detail.

Table 1 – Ratings & Part Number Reference cont.

| Rated Voltage VDC at 105°C | Rated Capacitance | Case Code/Case Size | KEMET Part Number | DC Leakage | DF | ESR | Maximum Allowable Ripple Current | Endurance | MSL | Maximum Operating Temperature | Derating Category |
|-------------------------------|-------------------|---------------------|------------------------------|-------------------------------|--------------------------|----------------------------|----------------------------------|-----------|---------------------|-------------------------------|-------------------|
| Not all parts are 105°C rated | µF | KEMET/EIA | (See below for part options) | µA at 25°C Maximum/ 5 Minutes | % at 25°C 120 Hz Maximum | mΩ at 25°C 100 kHz Maximum | (rms) mA at +45°C 100 kHz | (Hours) | Reflow Temp ≤ 260°C | °C | |
| 16 | 10 | B/3528-20 | T520B106M016A(3)E100 | 16 | 8 | 100 | 1,100 | 2,000 | 3 | 105 | 4 |
| 16 | 10 | B/3528-20 | T521B106M016A(3)E100 | 16 | 8 | 100 | 1,410 | 2,000 | 3 | 125 | 5 |
| 16 | 15 | B/3528-20 | T521B156M016A(3)E090 | 24 | 8 | 90 | 1,490 | 2,000 | 3 | 105 | 4 |
| 16 | 22 | 3216-08 | TF08A226M016APE200 ^ | 70.4 | 10 * | 200 | 548 | 1,000 | 4 | 105 | 4 |
| 16 | 22 | B/3528-20 | T521B226M016A(3)E090 | 35.2 | 8 | 90 | 1,490 | 2,000 | 3 | 105 | 4 |
| 16 | 22 | C/6032-28 | T520C226M016A(3)E080 | 35.2 | 8 | 80 | 1,400 | 2,000 | 3 | 105 | 4 |
| 16 | 33 | S/3216-12 | T527S336M016ATE200 ^ | 54 | 10 * | 200 | 548 | 1,000 | 4 | 105 | 4 |
| 16 | 33 | T/3528-12 | T521T336M016A(3)E045 | 52.8 | 8 | 45 | 1,890 | 2,000 | 3 | 105 | 4 |
| 16 | 33 | T/3528-12 | T521T336M016A(3)E050 | 52.8 | 10 | 50 | 1,790 | 2,000 | 3 | 105 | 4 |
| 16 | 33 | B/3528-20 | T521B336M016A(3)E070 | 52.8 | 8 | 70 | 1,690 | 2,000 | 3 | 125 | 8 |
| 16 | 33 | B/3528-20 | T521B336M016A(3)E090 | 52.8 | 8 | 90 | 1,490 | 2,000 | 3 | 125 | 8 |
| 16 | 33 | B/3528-20 | T525B336M016A(3)E070 | 52.8 | 8 | 70 | 1,300 | 2,000 | 3 | 125 | 6 |
| 16 | 33 | B/3528-20 | T525B336M016A(3)E090 | 52.8 | 8 | 90 | 1,200 | 2,000 | 3 | 125 | 6 |
| 16 | 33 | Q/7343-12 | T521Q336M016A(3)E040 | 52.8 | 10 | 40 | 2,500 | 2,000 | 3 | 105 | 4 |
| 16 | 33 | W/7343-15 | T520W336M016A(3)E045 | 52.8 | 10 | 45 | 2,000 | 2,000 | 3 | 105 | 4 |
| 16 | 33 | V/7343-19 | T520V336M016A(3)E045 | 52.8 | 10 | 45 | 2,000 | 2,000 | 3 | 105 | 4 |
| 16 | 33 | V/7343-19 | T520V336M016A(3)E060 | 52.8 | 10 | 60 | 1,800 | 2,000 | 3 | 105 | 4 |
| 16 | 33 | V/7343-19 | T520V336M016A(3)E070 | 52.8 | 10 | 70 | 1,600 | 2,000 | 3 | 105 | 4 |
| 16 | 47 | T/3528-12 | T523T476M016APE090 | 75.2 | 10 | 90 | 1,080 | 2,000 | 4 | 85 | 2 |
| 16 | 47 | B/3528-20 | T521B476M016A(3)E055 | 75.2 | 10 | 55 | 1,900 | 2,000 | 3 | 125 | 5 |
| 16 | 47 | B/3528-20 | T521B476M016A(3)E090 | 75.2 | 10 | 90 | 1,490 | 2,000 | 3 | 125 | 5 |
| 16 | 47 | W/7343-15 | T521W476M016A(3)E040 | 75.2 | 10 | 40 | 2,530 | 2,000 | 3 | 105 | 4 |
| 16 | 47 | W/7343-15 | T520W476M016A(3)E045 | 75.2 | 10 | 45 | 2,000 | 2,000 | 3 | 105 | 4 |
| 16 | 47 | W/7343-15 | T521W476M016A(3)E045 | 75.2 | 10 | 45 | 2,380 | 2,000 | 3 | 105 | 4 |
| 16 | 47 | V/7343-19 | T521V476M016A(3)E040 | 75.2 | 10 | 40 | 2,560 | 2,000 | 3 | 125 | 8 |
| 16 | 47 | V/7343-19 | T520V476M016A(3)E045 | 75.2 | 10 | 45 | 2,000 | 2,000 | 3 | 105 | 4 |
| 16 | 47 | V/7343-19 | T521V476M016A(3)E055 | 75.2 | 10 | 55 | 2,220 | 2,000 | 3 | 125 | 8 |
| 16 | 47 | V/7343-19 | T520V476M016A(3)E070 | 75.2 | 10 | 70 | 1,600 | 2,000 | 3 | 105 | 4 |
| 16 | 47 | V/7343-19 | T521V476M016A(3)E070 | 75.2 | 10 | 70 | 1,960 | 2,000 | 3 | 125 | 8 |
| 16 | 47 | V/7343-19 | T521V476M016A(3)E080 | 75.2 | 10 | 80 | 1,840 | 2,000 | 3 | 125 | 8 |
| 16 | 47 | D/7343-31 | T520D476M016A(3)E035 | 75.2 | 10 | 35 | 2,500 | 2,000 | 3 | 105 | 4 |
| 16 | 47 | D/7343-31 | T525D476M016A(3)E035 | 75.2 | 10 | 35 | 2,500 | 2,000 | 3 | 125 | 8 |
| 16 | 47 | D/7343-31 | T521D476M016A(3)E040 | 75.2 | 10 | 40 | 2,810 | 2,000 | 3 | 125 | 8 |
| 16 | 47 | D/7343-31 | T521D476M016A(3)E045 | 75.2 | 10 | 45 | 2,650 | 2,000 | 3 | 125 | 8 |
| 16 | 47 | D/7343-31 | T521D476M016A(3)E055 | 75.2 | 10 | 55 | 2,390 | 2,000 | 3 | 125 | 5 |
| 16 | 47 | D/7343-31 | T525D476M016A(3)E065 | 75.2 | 10 | 65 | 1,900 | 2,000 | 3 | 125 | 7 |
| 16 | 47 | D/7343-31 | T520D476M016A(3)E070 | 75.2 | 10 | 70 | 1,800 | 2,000 | 3 | 105 | 4 |
| 16 | 47 | D/7343-31 | T521D476M016A(3)E070 | 75.2 | 10 | 70 | 2,120 | 2,000 | 3 | 125 | 8 |
| 16 | 47 | D/7343-31 | T521D476M016A(3)E090 | 75.2 | 10 | 90 | 1,870 | 2,000 | 3 | 125 | 8 |
| 16 | 68 | W/7343-15 | T523W686M016APE050 | 108.8 | 10 | 50 | 2,820 | 2,000 | 3 | 105 | 4 |
| 16 | 68 | W/7343-15 | T523W686M016APE070 | 108.8 | 10 | 70 | 2,376 | 2,000 | 3 | 105 | 4 |
| VDC at 105°C | µF | KEMET/EIA | (See below for part options) | µA at 25°C Maximum/ 5 Minutes | % at 25°C 120 Hz Maximum | mΩ at 25°C 100 kHz Maximum | mA at +45°C 100 kHz | (Hours) | Reflow Temp ≤ 260°C | °C | |
| Rated Voltage | Rated Capacitance | Case Code/Case Size | KEMET Part Number | DC Leakage | DF | ESR | Maximum Allowable Ripple Current | Endurance | MSL | Maximum Operating Temp | Derating Category |

(2) To complete KEMET part number, insert M for ±20% or K for ±10%. Designates Capacitance tolerance.

(3) To complete KEMET part number, insert T = 100% Matte Tin (Sn)-plated or H = Standard Solder coated (SnPb 5% Pb minimum). Refer to Ordering Information for additional detail.

Higher voltage ratings and tighter ESR may be substituted within the same size at KEMET's option. Voltage substitutions will be marked with the higher voltage rating. Substitutions can include better than series.

Part numbers marked in blue font are not recommended for new designs. Please use the T521 series instead.

^ Denotes the large reel (13") is not available.

* DF measurement condition is 120 Hz/0.5 V_{rms}/1.5 V DC Bias

(1) ESR frequency condition is 300 - 500 kHz

Refer to Ordering Information for additional detail.

T52X/T530 Polymer Electrolytic Capacitors
KEMET Organic Capacitor (KO-CAP®)

Table 1 – Ratings & Part Number Reference cont.

| Rated Voltage VDC at 105°C | Rated Capacitance | Case Code/Case Size | KEMET Part Number | DC Leakage | DF | ESR | Maximum Allowable Ripple Current | Endurance | MSL | Maximum Operating Temperature | Derating Category |
|-------------------------------|-------------------|---------------------|------------------------------|------------------------------|--------------------------|----------------------------|----------------------------------|-----------|---------------------|-------------------------------|-------------------|
| Not all parts are 105°C rated | µF | KEMET/EIA | (See below for part options) | µA at 25°C Maximum/5 Minutes | % at 25°C 120 Hz Maximum | mΩ at 25°C 100 kHz Maximum | (rms) mA at +45°C 100 kHz | (Hours) | Reflow Temp ≤ 260°C | °C | |
| 16 | 68 | W/7343-15 | T523W686M016APE100 | 108.8 | 10 | 100 | 1,988 | 2,000 | 3 | 105 | 4 |
| 16 | 68 | V/7343-19 | T521V686M016A(3)E040 | 108.8 | 10 | 40 | 2,600 | 2,000 | 3 | 125 | 8 |
| 16 | 68 | V/7343-19 | T521V686M016A(3)E050 | 108.8 | 10 | 50 | 2,320 | 2,000 | 3 | 125 | 8 |
| 16 | 68 | V/7343-19 | T521V686M016A(3)E090 | 108.8 | 10 | 90 | 1,730 | 2,000 | 3 | 125 | 8 |
| 16 | 68 | D/7343-31 | T520D686M016A(3)E050 | 108.8 | 10 | 50 | 2,100 | 2,000 | 3 | 105 | 4 |
| 16 | 100 | W/7343-15 | T523W107M016APE050 | 160 | 10 | 50 | 2,820 | 2,000 | 3 | 105 | 4 |
| 16 | 100 | W/7343-15 | T523W107M016APE070 | 160 | 10 | 70 | 2,376 | 2,000 | 3 | 105 | 4 |
| 16 | 100 | W/7343-15 | T523W107M016APE100 | 160 | 10 | 100 | 1,988 | 2,000 | 3 | 105 | 4 |
| 16 | 100 | V/7343-19 | T521V107M016A(3)E040 | 160 | 10 | 40 | 2,600 | 2,000 | 3 | 125 | 8 |
| 16 | 100 | V/7343-19 | T521V107M016A(3)E050 | 160 | 10 | 50 | 2,320 | 2,000 | 3 | 125 | 8 |
| 16 | 100 | V/7343-20 | T521V107M016ATK050 | 80 | 10 | 50 | 2,320 | 2,000 | 3 | 125 | 5 |
| 16 | 100 | V/7343-20 | T521V107M016ATI050 | 48 | 10 | 50 | 2,320 | 2,000 | 3 | 125 | 5 |
| 16 | 100 | D/7343-31 | T521D107M016A(3)E050 | 160 | 10 | 50 | 2,510 | 2,000 | 3 | 105 | 4 |
| 16 | 150 | W/7343-15 | T523W157M016APE050 | 240 | 10 | 50 | 2,820 | 2,000 | 3 | 105 | 4 |
| 16 | 150 | W/7343-15 | T523W157M016APE070 | 240 | 10 | 70 | 2,376 | 2,000 | 3 | 105 | 4 |
| 16 | 150 | W/7343-15 | T523W157M016APE100 | 240 | 10 | 100 | 1,988 | 2,000 | 3 | 105 | 4 |
| 16 | 150 | V/7343-20 | T521V157M016ATE040 | 240 | 10 | 40 | 2,600 | 2,000 | 3 | 105 | 4 |
| 16 | 150 | V/7343-20 | T521V157M016ATE050 | 240 | 10 | 50 | 2,320 | 2,000 | 3 | 105 | 4 |
| 16 | 150 | V/7343-20 | T521V157M016ATK050 | 120 | 10 | 50 | 2,320 | 2,000 | 3 | 105 | 4 |
| 16 | 150 | V/7343-20 | T521V157M016ATE070 | 240 | 10 | 70 | 1,960 | 2,000 | 3 | 105 | 4 |
| 16 | 150 | V/7343-20 | T521V157M016ATK070 | 120 | 10 | 70 | 1,960 | 2,000 | 3 | 105 | 4 |
| 16 | 150 | V/7343-20 | T521V157M016ATE100 | 240 | 10 | 100 | 1,640 | 2,000 | 3 | 105 | 4 |
| 16 | 150 | V/7343-20 | T521V157M016ATK100 | 120 | 10 | 100 | 1,640 | 2,000 | 3 | 105 | 4 |
| 16 | 150 | D/7343-31 | T521D157M016A(3)E050 | 240 | 10 | 50 | 2,510 | 2,000 | 3 | 105 | 4 |
| 16 | 150 | D/7343-31 | T521D157M016A(3)E040 | 240 | 10 | 40 | 2,810 | 2,000 | 3 | 105 | 4 |
| 16 | 150 | X/7343-43 | T530X157M016A(3)E015 | 240 | 8 | 15 | 4,200 | 2,000 | 3 | 125 | 6 |
| 16 | 150 | X/7343-43 | T530X157M016A(3)E025 | 240 | 8 | 25 | 3,300 | 2,000 | 3 | 125 | 6 |
| 16 | 150 | X/7343-43 | T520X157M016A(3)E040 | 240 | 10 | 40 | 2,500 | 2,000 | 3 | 105 | 4 |
| 16 | 150 | X/7343-43 | T530X157M016A(3)E040 | 240 | 8 | 40 | 2,600 | 2,000 | 3 | 125 | 6 |
| 16 | 150 | X/7343-43 | T521X157M016A(3)E080 | 240 | 10 | 80 | 2,240 | 2,000 | 3 | 105 | 4 |
| 16 | 220 | D/7343-31 | T521D227M016A(3)E025 | 352 | 10 | 25 | 3,550 | 2,000 | 3 | 125 | 8 |
| 16 | 220 | D/7343-31 | T521D227M016A(3)E035 | 352 | 10 | 35 | 3,000 | 2,000 | 3 | 125 | 8 |
| 16 | 220 | D/7343-31 | T521D227M016A(3)E050 | 352 | 10 | 50 | 2,510 | 2,000 | 3 | 125 | 8 |
| 16 | 220 | X/7343-43 | T521X227M016A(3)E035 | 352 | 10 | 35 | 3,380 | 2,000 | 3 | 125 | 5 |
| 16 | 220 | X/7343-43 | T521X227M016A(3)E050 | 352 | 10 | 50 | 2,830 | 2,000 | 3 | 125 | 5 |
| 16 | 220 | H/7360-20 | T523H227M016APE070 | 352 | 10 | 70 | 2,510 | 2,000 | 3 | 85 | 2 |
| 16 | 220 | J/7360-15 | T523J227M016APE070 | 352 | 10 | 70 | 2,510 | 2,000 | 3 | 85 | 2 |
| 16 | 330 | X/7343-43 | T521X337M016A(3)E015 | 528 | 10 | 15 | 5,160 | 2,000 | 3 | 125 | 5 |
| 16 | 330 | X/7343-43 | T521X337M016A(3)E025 | 528 | 10 | 25 | 4,000 | 2,000 | 3 | 125 | 5 |
| 16 | 330 | X/7343-43 | T521X337M016A(3)K025 | 264 | 10 | 25 | 4,000 | 2,000 | 3 | 125 | 5 |
| 16 | 330 | X/7343-43 | T521X337M016A(3)E050 | 528 | 10 | 50 | 2,830 | 2,000 | 3 | 125 | 5 |
| VDC at 105°C | µF | KEMET/EIA | (See below for part options) | µA at 25°C Maximum/5 Minutes | % at 25°C 120 Hz Maximum | mΩ at 25°C 100 kHz Maximum | mA at +45°C 100 kHz | (Hours) | Reflow Temp ≤ 260°C | °C | |
| Rated Voltage | Rated Capacitance | Case Code/Case Size | KEMET Part Number | DC Leakage | DF | ESR | Maximum Allowable Ripple Current | Endurance | MSL | Maximum Operating Temp | Derating Category |

(2) To complete KEMET part number, insert M for ±20% or K for ±10%. Designates Capacitance tolerance.

(3) To complete KEMET part number, insert T = 100% Matte Tin (Sn)-plated or H = Standard Solder coated (SnPb 5% Pb minimum). Refer to Ordering Information for additional detail.

Higher voltage ratings and tighter ESR may be substituted within the same size at KEMET's option. Voltage substitutions will be marked with the higher voltage rating. Substitutions can include better than series.

Part numbers marked in blue font are not recommended for new designs. Please use the T521 series instead.

^ Denotes the large reel (13") is not available.

* DF measurement condition is 120 Hz/0.5 V_{rms}/1.5 V DC Bias

(1) ESR frequency condition is 300 - 500 kHz

Refer to Ordering Information for additional detail.

Table 1 – Ratings & Part Number Reference cont.

| Rated Voltage VDC at 105°C | Rated Capacitance | Case Code/Case Size | KEMET Part Number | DC Leakage | DF | ESR | Maximum Allowable Ripple Current | Endurance | MSL | Maximum Operating Temperature | Derating Category |
|-------------------------------|-------------------|---------------------|------------------------------|------------------------------|--------------------------|----------------------------|----------------------------------|-----------|---------------------|-------------------------------|-------------------|
| Not all parts are 105°C rated | µF | KEMET/EIA | (See below for part options) | µA at 25°C Maximum/5 Minutes | % at 25°C 120 Hz Maximum | mΩ at 25°C 100 kHz Maximum | (rms) mA at +45°C 100 kHz | (Hours) | Reflow Temp ≤ 260°C | °C | |
| 16 | 330 | X/7343-43 | T521X337M016A(3)K050 | 264 | 10 | 50 | 2,830 | 2,000 | 3 | 125 | 5 |
| 16 | 330 | H/7360-20 | T523H337M016APE070 | 528 | 10 | 70 | 2,510 | 2,000 | 3 | 85 | 2 |
| 16 | 470 | X/7343-43 | T521X477M016A(3)E020 | 752 | 10 | 20 | 4,470 | 2,000 | 3 | 125 | 5 |
| 16 | 470 | X/7343-43 | T521X477M016A(3)K020 | 376 | 10 | 20 | 4,470 | 2,000 | 3 | 125 | 5 |
| 16 | 470 | X/7343-43 | T521X477M016A(3)I020 | 226 | 10 | 20 | 4,470 | 2,000 | 3 | 125 | 5 |
| 18 | 27 | T/3528-12 | T521T276M018ATE055 | 48.6 | 8 | 55 | 1,706 | 2,000 | 3 | 105 | 4 |
| 20 | 10 | B/3528-20 | T521B106M020A(3)E100 | 20 | 8 | 100 | 1,410 | 2,000 | 3 | 125 | 5 |
| 20 | 15 | B/3528-20 | T521B156M020A(3)E090 | 30 | 10 | 90 | 1,490 | 2,000 | 3 | 105 | 4 |
| 20 | 22 | B/3528-20 | T521B226M020A(3)E090 | 44 | 8 | 90 | 1,490 | 2,000 | 3 | 105 | 4 |
| 20 | 22 | W/7343-15 | T521W226(2)020A(3)E040 | 44 | 10 | 40 | 2,530 | 2,000 | 3 | 105 | 4 |
| 20 | 22 | W/7343-15 | T521W226(2)020A(3)E055 | 44 | 10 | 55 | 2,150 | 2,000 | 3 | 105 | 4 |
| 20 | 22 | W/7343-15 | T521W226(2)020A(3)E070 | 44 | 10 | 70 | 1,910 | 2,000 | 3 | 105 | 4 |
| 20 | 22 | V/7343-19 | T520V226M020A(3)E040 | 44 | 10 | 40 | 2,200 | 2,000 | 3 | 105 | 4 |
| 20 | 22 | V/7343-19 | T520V226M020A(3)E045 | 44 | 10 | 45 | 2,000 | 2,000 | 3 | 105 | 4 |
| 20 | 22 | V/7343-19 | T520V226M020A(3)E090 | 44 | 10 | 90 | 1,400 | 2,000 | 3 | 105 | 4 |
| 20 | 22 | V/7343-19 | T521V226M020A(3)E090 | 44 | 10 | 90 | 1,730 | 2,000 | 3 | 125 | 8 |
| 20 | 33 | B/3528-20 | T521B336M020A(3)E070 | 66 | 8 | 70 | 1,690 | 2,000 | 3 | 125 | 8 |
| 20 | 33 | B/3528-20 | T521B336M020ATE090 ^ | 132 | 10 * | 90 | 972 | 2,000 | 3 | 105 | 4 |
| 20 | 33 | B/3528-20 | T521B336M020A(3)E100 | 66 | 8 | 100 | 1,410 | 2,000 | 3 | 125 | 8 |
| 20 | 47 | W/7343-15 | T521W476M020A(3)E040 | 94 | 9 | 40 | 2,530 | 2,000 | 3 | 105 | 4 |
| 20 | 47 | W/7343-15 | T521W476M020A(3)E045 | 94 | 9 | 45 | 2,380 | 2,000 | 3 | 105 | 4 |
| 20 | 47 | V/7343-19 | T521V476M020A(3)E090 | 94 | 10 | 90 | 1,730 | 2,000 | 3 | 125 | 5 |
| 20 | 47 | V/7343-19 | T521V476M020A(3)E080 | 94 | 10 | 80 | 1,840 | 2,000 | 3 | 125 | 5 |
| 20 | 47 | V/7343-19 | T521V476M020A(3)E055 | 94 | 10 | 55 | 2,220 | 2,000 | 3 | 125 | 5 |
| 20 | 47 | D/7343-31 | T521D476M020A(3)E055 | 94 | 10 | 55 | 2,390 | 2,000 | 3 | 125 | 5 |
| 20 | 47 | D/7343-31 | T521D476M020A(3)E040 | 94 | 10 | 40 | 2,810 | 2,000 | 3 | 125 | 5 |
| 20 | 68 | V/7343-19 | T521V686M020A(3)E050 | 136 | 10 | 50 | 2,320 | 2,000 | 3 | 105 | 4 |
| 20 | 68 | V/7343-20 | T523V686M020APE100 | 136 | 10 | 100 | 2,060 | 2,000 | 3 | 105 | 4 |
| 20 | 100 | W/7343-15 | T523W107M020APE050 | 200 | 10 | 50 | 2,820 | 2,000 | 3 | 105 | 4 |
| 20 | 100 | W/7343-15 | T523W107M020APE070 | 200 | 10 | 70 | 2,376 | 2,000 | 3 | 105 | 4 |
| 20 | 100 | W/7343-15 | T523W107M020APE100 | 200 | 10 | 100 | 1,988 | 2,000 | 3 | 105 | 4 |
| 20 | 100 | V/7343-19 | T521V107M020A(3)E055 | 200 | 10 | 55 | 2,220 | 2,000 | 3 | 125 | 5 |
| 20 | 100 | D/7343-31 | T521D107(2)020A(3)E055 | 200 | 10 | 55 | 2,390 | 2,000 | 3 | 125 | 7 |
| 20 | 150 | V/7343-20 | T523V157M020APE050 | 300 | 10 | 50 | 2,870 | 2,000 | 3 | 105 | 4 |
| 20 | 150 | V/7343-20 | T523V157M020APE070 | 300 | 10 | 70 | 2,420 | 2,000 | 3 | 105 | 4 |
| 20 | 150 | V/7343-20 | T523V157M020APE100 | 300 | 10 | 100 | 2,030 | 2,000 | 3 | 105 | 4 |
| 20 | 150 | D/7343-31 | T521D157M020A(3)E065 | 300 | 10 | 65 | 2,200 | 2,000 | 3 | 105 | 4 |
| 20 | 150 | D/7343-31 | T521D157M020A(3)E050 | 300 | 10 | 50 | 2,510 | 2,000 | 3 | 105 | 4 |
| 25 | 4.7 | P/2012-10 | T529P475M025AAE300 ^ | 35.3 | 10 * | 300 | 289 | 1,000 | 3 | 105 | 4 |
| 25 | 6.8 | T/3528-12 | T521T685M025ATE100 ^ | 34 | 8 * | 100 | 866 | 2,000 | 3 | 105 | 4 |
| 25 | 10 | S/3216-12 | T527S106M025ATE150 ^ | 50 | 10 * | 150 | 632 | 1,000 | 3 | 105 | 4 |
| VDC at 105°C | µF | KEMET/EIA | (See below for part options) | µA at 25°C Maximum/5 Minutes | % at 25°C 120 Hz Maximum | mΩ at 25°C 100 kHz Maximum | mA at +45°C 100 kHz | (Hours) | Reflow Temp ≤ 260°C | °C | |
| Rated Voltage | Rated Capacitance | Case Code/Case Size | KEMET Part Number | DC Leakage | DF | ESR | Maximum Allowable Ripple Current | Endurance | MSL | Maximum Operating Temp | Derating Category |

(2) To complete KEMET part number, insert M for ±20% or K for ±10%. Designates Capacitance tolerance.

(3) To complete KEMET part number, insert T = 100% Matte Tin (Sn)-plated or H = Standard Solder coated (SnPb 5% Pb minimum). Refer to Ordering Information for additional detail.

Higher voltage ratings and tighter ESR may be substituted within the same size at KEMET's option. Voltage substitutions will be marked with the higher voltage rating. Substitutions can include better than series.

Part numbers marked in blue font are not recommended for new designs. Please use the T521 series instead.

^ Denotes the large reel (13") is not available.

* DF measurement condition is 120 Hz/0.5 V_{rms}/1.5 V DC Bias

(1) ESR frequency condition is 300 - 500 kHz

Refer to Ordering Information for additional detail.

Table 1 – Ratings & Part Number Reference cont.

| Rated Voltage VDC at 105°C | Rated Capacitance | Case Code/ Case Size | KEMET Part Number | DC Leakage | DF | ESR | Maximum Allowable Ripple Current | Endurance | MSL | Maximum Operating Temperature | Derating Category |
|-------------------------------|-------------------|----------------------|------------------------------|-------------------------------|--------------------------|----------------------------|----------------------------------|-----------|---------------------|-------------------------------|-------------------|
| Not all parts are 105°C rated | µF | KEMET/EIA | (See below for part options) | µA at 25°C Maximum/ 5 Minutes | % at 25°C 120 Hz Maximum | mΩ at 25°C 100 kHz Maximum | (rms) mA at +45°C 100 kHz | (Hours) | Reflow Temp ≤ 260°C | °C | |
| 25 | 10 | A/3216-18 | T521A106M025ATE150 ^ | 25 | 6 * | 150 | 707 | 2,000 | 3 | 105 | 4a |
| 25 | 10 | M/3528-15 | T521M106M025ATE100 ^ | 50 | 10 * | 100 | 922 | 2,000 | 3 | 105 | 4 |
| 25 | 10 | B/3528-20 | T521B106M025A(3)E100 | 25 | 8 | 100 | 1,410 | 2,000 | 3 | 125 | 5 |
| 25 | 10 | T/3528-12 | T521T106M025A(3)E100 | 25 | 8 | 100 | 1,270 | 2,000 | 3 | 125 | 5 |
| 25 | 10 | T/3528-12 | T521T106M025A(3)E060 | 25 | 8 | 60 | 1,630 | 2,000 | 3 | 125 | 5 |
| 25 | 15 | B/3528-20 | T521B156M025ATE090 ^ | 112.5 | 10 * | 90 | 972 | 2,000 | 3 | 125 | 6 |
| 25 | 15 | B/3528-20 | T521B156M025A(3)E100 | 37.5 | 8 | 100 | 1,410 | 2,000 | 3 | 125 | 7 |
| 25 | 15 | T/3528-12 | T521T156M025ATE100 ^ | 112.5 | 10 * | 100 | 866 | 2,000 | 3 | 105 | 4 |
| 25 | 15 | K/3528-10 | T527K156M025ATE150 ^ | 75.0 | 10 * | 150 | 633 | 1,000 | 3 | 105 | 4 |
| 25 | 15 | V/7343-19 | T520V156M025A(3)E090** | 37.5 | 10 | 90 | 1,400 | 2,000 | 3 | 105 | 4 |
| 25 | 15 | V/7343-19 | T521V156M025A(3)E090 | 37.5 | 10 | 90 | 1,730 | 2,000 | 3 | 105 | 4 |
| 25 | 15 | V/7343-19 | T521V156M025A(3)E040 | 37.5 | 10 | 40 | 2,560 | 2,000 | 3 | 105 | 4 |
| 25 | 15 | D/7343-31 | T520D156M025A(3)E060 | 37.5 | 10 | 60 | 1,900 | 2,000 | 3 | 105 | 4 |
| 25 | 15 | D/7343-31 | T520D156M025A(3)E080 | 37.5 | 10 | 80 | 1,700 | 2,000 | 3 | 105 | 4 |
| 25 | 22 | T/3528-12 | T527T226M025ATE090 ^ | 110 | 10 * | 90 | 913 | 2,000 | 3 | 125 | 6 |
| 25 | 22 | T/3528-12 | T527T226M025ATE100 ^ | 165 | 10 * | 100 | 886 | 2,000 | 3 | 105 | 4 |
| 25 | 22 | B/3528-20 | T521B226M025A(3)E100 | 55 | 8 | 100 | 1,410 | 2,000 | 3 | 125 | 8 |
| 25 | 22 | W/7343-15 | T521W226M025A(3)E040 | 55 | 10 | 40 | 2,530 | 2,000 | 3 | 105 | 4 |
| 25 | 22 | W/7343-15 | T521W226M025A(3)E070 | 55 | 10 | 70 | 1,910 | 2,000 | 3 | 105 | 4 |
| 25 | 22 | V/7343-19 | T521V226M025A(3)E040 | 55 | 10 | 40 | 2,560 | 2,000 | 3 | 125 | 7 |
| 25 | 22 | V/7343-19 | T521V226M025A(3)E045 | 55 | 10 | 45 | 2,450 | 2,000 | 3 | 125 | 7 |
| 25 | 22 | V/7343-19 | T521V226M025A(3)E060 | 55 | 10 | 60 | 2,120 | 2,000 | 3 | 125 | 7 |
| 25 | 22 | V/7343-19 | T521V226M025A(3)E090 | 55 | 10 | 90 | 1,730 | 2,000 | 3 | 125 | 7 |
| 25 | 33 | B/3528-20 | T527B336M025ATE100^ | 82.5 | 10* | 100 | 922 | 2,000 | 3 | 105 | 4 |
| 25 | 33 | W/7343-15 | T523W336M025APE100 | 82.5 | 10 | 100 | 1,988 | 2,000 | 4 | 105 | 4 |
| 25 | 33 | V/7343-19 | T521V336M025A(3)E025 | 82.5 | 10 | 25 | 3,290 | 2,000 | 3 | 125 | 7 |
| 25 | 33 | V/7343-19 | T521V336M025A(3)E060 | 82.5 | 10 | 60 | 2,120 | 2,000 | 3 | 125 | 7 |
| 25 | 33 | V/7343-19 | T521V336M025A(3)E040 | 82.5 | 10 | 40 | 2,560 | 2,000 | 3 | 125 | 7 |
| 25 | 33 | D/7343-31 | T521D336M025A(3)E040 | 82.5 | 10 | 40 | 2,810 | 2,000 | 3 | 125 | 8 |
| 25 | 33 | D/7343-31 | T521D336M025A(3)E060 | 82.5 | 10 | 60 | 2,290 | 2,000 | 3 | 125 | 8 |
| 25 | 47 | V/7343-20 | T523V476M025APE100 | 117.5 | 10 | 100 | 2,060 | 2,000 | 3 | 105 | 4 |
| 25 | 47 | V/7343-20 | T521V476M025ATE040 | 117.5 | 10 | 40 | 2,560 | 2,000 | 3 | 125 | 6 |
| 25 | 47 | V/7343-20 | T521V476M025ATE060 | 117.5 | 10 | 60 | 2,120 | 2,000 | 3 | 125 | 6 |
| 25 | 47 | D/7343-31 | T521D476M025A(3)E065 | 117.5 | 10 | 65 | 2,200 | 2,000 | 3 | 125 | 8 |
| 25 | 47 | W/7343-15 | T523W476M025APE050 | 117.5 | 10 | 50 | 2,820 | 2,000 | 3 | 105 | 4 |
| 25 | 47 | W/7343-15 | T523W476M025APE070 | 117.5 | 10 | 70 | 2,376 | 2,000 | 3 | 105 | 4 |
| 25 | 47 | W/7343-15 | T523W476M025APE100 | 117.5 | 10 | 100 | 1,988 | 2,000 | 3 | 105 | 4 |
| 25 | 68 | W/7343-15 | T523W686M025APE050 | 170 | 10 | 50 | 2,820 | 2,000 | 3 | 105 | 4 |
| 25 | 68 | W/7343-15 | T523W686M025APE070 | 170 | 10 | 70 | 2,376 | 2,000 | 3 | 105 | 4 |
| 25 | 68 | W/7343-15 | T523W686M025APE100 | 170 | 10 | 100 | 1,988 | 2,000 | 3 | 105 | 4 |
| 25 | 68 | V/7343-20 | T521V686M025ATE050 | 170 | 10 | 50 | 2,320 | 2,000 | 3 | 125 | 7 |
| 25 | 68 | V/7343-20 | T521V686M025ATE100 | 170 | 10 | 100 | 1,270 | 2,000 | 3 | 125 | 7 |
| 25 | 68 | D/7343-31 | T521D686M025A(3)E070 | 170 | 10 | 70 | 2,120 | 2,000 | 3 | 125 | 8 |
| VDC at 105°C | µF | KEMET/EIA | (See below for part options) | µA at 25°C Maximum/ 5 Minutes | % at 25°C 120 Hz Maximum | mΩ at 25°C 100 kHz Maximum | mA at +45°C 100 kHz | (Hours) | Reflow Temp ≤ 260°C | °C | |
| Rated Voltage | Rated Capacitance | Case Code/ Case Size | KEMET Part Number | DC Leakage | DF | ESR | Maximum Allowable Ripple Current | Endurance | MSL | Maximum Operating Temp | Derating Category |

(2) To complete KEMET part number, insert M for ±20% or K for ±10%. Designates Capacitance tolerance.

(3) To complete KEMET part number, insert T = 100% Matte Tin (Sn)-plated or H = Standard Solder coated (SnPb 5% Pb minimum). Refer to Ordering Information for additional detail.

Higher voltage ratings and tighter ESR may be substituted within the same size at KEMET's option. Voltage substitutions will be marked with the higher voltage rating. Substitutions can include better than series.

Part numbers marked in blue font are not recommended for new designs. Please use the T521 series instead.

^ Denotes the large reel (13") is not available.

* DF measurement condition is 120 Hz/0.5 V_{rms}/1.5 V DC Bias

(1) ESR frequency condition is 300 - 500 kHz

Refer to Ordering Information for additional detail.

T52X/T530 Polymer Electrolytic Capacitors
KEMET Organic Capacitor (KO-CAP®)

Table 1 – Ratings & Part Number Reference cont.

| Rated Voltage VDC at 105°C | Rated Capacitance | Case Code/Case Size | KEMET Part Number | DC Leakage | DF | ESR | Maximum Allowable Ripple Current | Endurance | MSL | Maximum Operating Temperature | Derating Category |
|-------------------------------|-------------------|---------------------|------------------------------|------------------------------|--------------------------|----------------------------|----------------------------------|-----------|---------------------|-------------------------------|-------------------|
| Not all parts are 105°C rated | µF | KEMET/EIA | (See below for part options) | µA at 25°C Maximum/5 Minutes | % at 25°C 120 Hz Maximum | mΩ at 25°C 100 kHz Maximum | (rms) mA at +45°C 100 kHz | (Hours) | Reflow Temp ≤ 260°C | °C | |
| 25 | 100 | D/7343-31 | T521D107M025A(3)E040 | 250 | 10 | 40 | 2,810 | 2,000 | 3 | 125 | 8 |
| 25 | 100 | D/7343-31 | T521D107M025A(3)E050 | 250 | 10 | 50 | 2,510 | 2,000 | 3 | 125 | 8 |
| 25 | 100 | D/7343-31 | T521D107M025A(3)E060 | 250 | 10 | 60 | 2,290 | 2,000 | 3 | 125 | 8 |
| 25 | 100 | X/7343-43 | T521X107M025A(3)E030 | 250 | 10 | 30 | 3,650 | 2,000 | 3 | 125 | 7 |
| 25 | 100 | X/7343-43 | T521X107M025A(3)E060 | 250 | 10 | 60 | 2,580 | 2,000 | 3 | 125 | 7 |
| 25 | 150 | D/7343-31 | T521D157M025ATE040 | 375 | 10 | 40 | 2,810 | 2,000 | 3 | 125 | 7 |
| 25 | 150 | D/7343-31 | T521D157M025ATE050 | 375 | 10 | 50 | 2,510 | 2,000 | 3 | 125 | 7 |
| 35 | 3.3 | B/3528-20 | T521B335M035A(3)E150 | 11.6 | 8 | 150 | 1,160 | 2,000 | 3 | 105 | 4 |
| 35 | 3.3 | B/3528-20 | T521B335M035A(3)E200 | 11.6 | 8 | 200 | 1,000 | 2,000 | 3 | 105 | 4 |
| 35 | 4.7 | B/3528-20 | T521B475M035A(3)E150 | 16.5 | 8 | 150 | 1,160 | 2,000 | 3 | 105 | 4 |
| 35 | 4.7 | B/3528-20 | T521B475M035A(3)E200 | 16.5 | 8 | 200 | 1,000 | 2,000 | 3 | 105 | 4 |
| 35 | 6.8 | T/3528-12 | T521T685M035APE090 | 23.8 | 10 | 90 | 1,330 | 2,000 | 3 | 125 | 5 |
| 35 | 6.8 | B/3528-20 | T521B685M035A(3)E150 | 23.8 | 8 | 150 | 1,160 | 2,000 | 3 | 105 | 4 |
| 35 | 6.8 | B/3528-20 | T521B685M035A(3)E200 | 23.8 | 8 | 200 | 1,000 | 2,000 | 3 | 105 | 4 |
| 35 | 10 | T/3528-12 | T521T106M035APE100 | 35 | 8 | 100 | 1,270 | 2,000 | 4 | 105 | 4 |
| 35 | 10 | B/3528-20 | T521B106M035ATE100 | 35 | 8 | 100 | 1,410 | 1,000 | 3 | 125 | 6 |
| 35 | 10 | B/3528-20 | T521B106M035A(3)E150 | 35 | 8 | 150 | 1,160 | 2,000 | 3 | 105 | 4 |
| 35 | 10 | B/3528-20 | T521B106M035A(3)E200 | 35 | 8 | 200 | 1,000 | 2,000 | 3 | 105 | 4 |
| 35 | 10 | V/7343-19 | T521V106M035A(3)E120 | 35 | 10 | 120 | 1,500 | 2,000 | 3 | 125 | 5 |
| 35 | 15 | B/3528-20 | T521B156M035ATE100 | 52.5 | 8 | 100 | 1,410 | 2,000 | 3 | 125 | 6 |
| 35 | 15 | B/3528-20 | T521B156M035ATE150 | 52.5 | 8 | 150 | 1,160 | 2,000 | 3 | 125 | 6 |
| 35 | 15 | B/3528-20 | T521B156M035ATE200 | 52.5 | 8 | 200 | 1,000 | 2,000 | 3 | 125 | 6 |
| 35 | 15 | V/7343-19 | T521V156M035A(3)E100 | 52.5 | 10 | 100 | 1,640 | 2,000 | 3 | 125 | 5 |
| 35 | 15 | V/7343-19 | T521V156M035A(3)E125 | 52.5 | 10 | 125 | 1,470 | 2,000 | 3 | 125 | 5 |
| 35 | 22 | W/7343-15 | T523W226M035APE100 | 77 | 10 | 100 | 1,988 | 2,000 | 3 | 105 | 4 |
| 35 | 22 | V/7343-20 | T521V226M035ATE065 | 77 | 10 | 65 | 2,040 | 2,000 | 3 | 105 | 4 |
| 35 | 22 | V/7343-20 | T521V226M035ATE100 | 77 | 10 | 100 | 1,640 | 2,000 | 3 | 105 | 4 |
| 35 | 22 | D/7343-31 | T521D226M035A(3)E040 | 77 | 10 | 40 | 2,810 | 2,000 | 3 | 125 | 5 |
| 35 | 22 | D/7343-31 | T521D226M035A(3)E060 | 77 | 10 | 60 | 2,290 | 2,000 | 3 | 125 | 5 |
| 35 | 33 | V/7343-20 | T521V336M035ATE100 | 115.5 | 10 | 100 | 1,640 | 2,000 | 3 | 105 | 4 |
| 35 | 33 | V/7343-20 | T523V336M035APE100 | 115.5 | 10 | 100 | 2,060 | 2,000 | 3 | 105 | 4 |
| 35 | 33 | D/7343-31 | T521D336M035A(3)E065 | 115.5 | 10 | 65 | 2,200 | 2,000 | 3 | 125 | 5 |
| 35 | 47 | V/7343-20 | T521V476M035ATE100 | 164.5 | 10 | 100 | 1,640 | 2,000 | 3 | 105 | 4 |
| 35 | 47 | V/7343-20 | T523V476M035APE100 | 164.5 | 10 | 100 | 2,060 | 2,000 | 3 | 105 | 4 |
| 35 | 47 | D/7343-31 | T521D476M035ATE060 | 164.5 | 10 | 60 | 2,290 | 2,000 | 3 | 125 | 5 |
| 35 | 47 | D/7343-31 | T521D476M035ATE070 | 164.5 | 10 | 70 | 2,120 | 2,000 | 3 | 125 | 5 |
| 35 | 47 | X/7343-43 | T521X476M035A(3)E030 | 164.5 | 10 | 30 | 3,650 | 2,000 | 3 | 125 | 5 |
| 35 | 47 | X/7343-43 | T521X476M035A(3)E070 | 164.5 | 10 | 70 | 2,390 | 2,000 | 3 | 125 | 5 |
| 35 | 47 | W/7343-15 | T523W476M035APE090 | 164.5 | 10 | 90 | 2,100 | 2,000 | 3 | 105 | 4 |
| 35 | 47 | W/7343-15 | T523W476M035APE100 | 164.5 | 10 | 100 | 1,988 | 2,000 | 3 | 105 | 4 |
| 35 | 56 | W/7343-15 | T523W566M035APE070 | 196 | 10 | 70 | 2,376 | 2,000 | 3 | 105 | 4 |
| 35 | 56 | W/7343-15 | T523W566M035APE100 | 196 | 10 | 100 | 1,988 | 2,000 | 3 | 105 | 4 |
| 35 | 68 | X/7343-43 | T521X686M035A(3)E050 | 238 | 10 | 50 | 2,830 | 2,000 | 3 | 125 | 5 |
| VDC at 105°C | µF | KEMET/EIA | (See below for part options) | µA at 25°C Maximum/5 Minutes | % at 25°C 120 Hz Maximum | mΩ at 25°C 100 kHz Maximum | mA at +45°C 100 kHz | (Hours) | Reflow Temp ≤ 260°C | °C | |
| Rated Voltage | Rated Capacitance | Case Code/Case Size | KEMET Part Number | DC Leakage | DF | ESR | Maximum Allowable Ripple Current | Endurance | MSL | Maximum Operating Temp | Derating Category |

(2) To complete KEMET part number, insert M for ±20% or K for ±10%. Designates Capacitance tolerance.

(3) To complete KEMET part number, insert T = 100% Matte Tin (Sn)-plated or H = Standard Solder coated (SnPb 5% Pb minimum). Refer to Ordering Information for additional detail.

Higher voltage ratings and tighter ESR may be substituted within the same size at KEMET's option. Voltage substitutions will be marked with the higher voltage rating. Substitutions can include better than series.

Part numbers marked in blue font are not recommended for new designs. Please use the T521 series instead.

^ Denotes the large reel (13") is not available.

* DF measurement condition is 120 Hz/0.5 V_{rms}/1.5 V DC Bias

(1) ESR frequency condition is 300 - 500 kHz

Refer to Ordering Information for additional detail.

Table 1 – Ratings & Part Number Reference cont.

| Rated Voltage VDC at 105°C | Rated Capacitance | Case Code/ Case Size | KEMET Part Number | DC Leakage | DF | ESR | Maximum Allowable Ripple Current | Endurance | MSL | Maximum Operating Temperature | Derating Category |
|-------------------------------|-------------------|----------------------|------------------------------|-------------------------------|--------------------------|----------------------------|----------------------------------|-----------|---------------------|-------------------------------|-------------------|
| Not all parts are 105°C rated | µF | KEMET/EIA | (See below for part options) | µA at 25°C Maximum/ 5 Minutes | % at 25°C 120 Hz Maximum | mΩ at 25°C 100 kHz Maximum | (rms) mA at +45°C 100 kHz | (Hours) | Reflow Temp ≤ 260°C | °C | |
| 50 | 0.68 | B/3528-20 | T521B684M050A(3)E200 | 3.4 | 8 | 200 | 1,000 | 2,000 | 3 | 105 | 4 |
| 50 | 1 | B/3528-20 | T521B105M050A(3)E200 | 5 | 8 | 200 | 1,000 | 2,000 | 3 | 105 | 4 |
| 50 | 1.5 | B/3528-20 | T521B155M050A(3)E200 | 7.5 | 8 | 200 | 1,000 | 2,000 | 3 | 105 | 4 |
| 50 | 2.2 | B/3528-20 | T521B225M050A(3)E200 | 11 | 8 | 200 | 1,000 | 2,000 | 3 | 105 | 4 |
| 50 | 3.3 | B/3528-20 | T521B335M050A(3)E200 | 16.5 | 8 | 200 | 1,000 | 2,000 | 3 | 105 | 4 |
| 50 | 5.6 | D/7343-31 | T521D565M050A(3)E070 | 28 | 10 | 70 | 2,120 | 2,000 | 3 | 125 | 5 |
| 50 | 5.6 | D/7343-31 | T521D565M050A(3)E090 | 28 | 10 | 90 | 1,870 | 2,000 | 3 | 125 | 5 |
| 50 | 5.6 | V/7343-19 | T521V565M050A(3)E070 | 28 | 10 | 70 | 1,960 | 2,000 | 3 | 125 | 5 |
| 50 | 5.6 | V/7343-19 | T521V565M050A(3)E090 | 28 | 10 | 90 | 1,730 | 2,000 | 3 | 125 | 5 |
| 50 | 6.8 | D/7343-31 | T521D685M050A(3)E070 | 34 | 10 | 70 | 2,120 | 2,000 | 3 | 125 | 5 |
| 50 | 6.8 | D/7343-31 | T521D685M050A(3)E090 | 34 | 10 | 90 | 1,870 | 2,000 | 3 | 125 | 5 |
| 50 | 6.8 | V/7343-19 | T521V685M050A(3)E070 | 34 | 10 | 70 | 1,960 | 2,000 | 3 | 125 | 5 |
| 50 | 6.8 | V/7343-19 | T521V685M050A(3)E090 | 34 | 10 | 90 | 1,730 | 2,000 | 3 | 125 | 5 |
| 50 | 10 | D/7343-31 | T521D106M050A(3)E090 | 50 | 10 | 90 | 1,870 | 2,000 | 3 | 125 | 5 |
| 50 | 10 | D/7343-31 | T521D106M050A(3)E120 | 50 | 10 | 120 | 1,620 | 2,000 | 3 | 125 | 5 |
| 50 | 10 | V/7343-19 | T521V106M050A(3)E090 | 50 | 10 | 90 | 1,730 | 2,000 | 3 | 125 | 5 |
| 50 | 18 | D/7343-31 | T521D186M050A(3)E090 | 90 | 10 | 90 | 1,870 | 2,000 | 3 | 125 | 5 |
| 50 | 18 | X/7343-43 | T521X186M050A(3)E070 | 90 | 10 | 70 | 2,390 | 2,000 | 3 | 125 | 5 |
| 50 | 18 | X/7343-43 | T521X186M050A(3)E050 | 90 | 10 | 50 | 2,830 | 2,000 | 3 | 125 | 5 |
| 50 | 18 | X/7343-43 | T521X186M050A(3)E035 | 90 | 10 | 35 | 3,380 | 2,000 | 3 | 125 | 5 |
| 50 | 22 | D/7343-31 | T521D226M050A(3)E090 | 110 | 10 | 90 | 1,870 | 2,000 | 3 | 125 | 5 |
| 50 | 22 | X/7343-43 | T521X226M050A(3)E075 | 110 | 10 | 75 | 2,310 | 2,000 | 3 | 125 | 5 |
| 50 | 22 | X/7343-43 | T521X226M050A(3)E050 | 110 | 10 | 50 | 2,830 | 2,000 | 3 | 125 | 5 |
| 50 | 33 | X/7343-43 | T521X336M050A(3)E075 | 165 | 10 | 75 | 2,310 | 2,000 | 3 | 125 | 5 |
| 50 | 33 | X/7343-43 | T521X336M050A(3)E050 | 165 | 10 | 50 | 2,830 | 2,000 | 3 | 125 | 5 |
| 63 | 0.68 | B/3528-20 | T521B684M063A(3)E200 | 4.3 | 8 | 200 | 1,000 | 2,000 | 3 | 105 | 4 |
| 63 | 1 | B/3528-20 | T521B105M063A(3)E200 | 6.3 | 8 | 200 | 1,000 | 2,000 | 3 | 105 | 4 |
| 63 | 1.5 | B/3528-20 | T521B155M063A(3)E200 | 9.5 | 8 | 200 | 1,000 | 2,000 | 3 | 105 | 4 |
| 63 | 4.7 | C/6032-28 | T521C475M063A(3)E200 | 29.6 | 6 | 200 | 1,050 | 2,000 | 3 | 105 | 4 |
| 63 | 4.7 | D/7343-31 | T521D475M063A(3)E300 | 29.6 | 10 | 300 | 1,030 | 2,000 | 3 | 125 | 5 |
| 63 | 4.7 | D/7343-31 | T521D475M063A(3)E075 | 29.6 | 10 | 75 | 2,050 | 2,000 | 3 | 125 | 5 |
| 63 | 6.8 | D/7343-31 | T521D685M063A(3)E075 | 42.8 | 10 | 75 | 2,050 | 2,000 | 3 | 125 | 5 |
| 63 | 10 | X/7343-43 | T521X106M063A(3)E050 | 63 | 10 | 50 | 2,830 | 2,000 | 3 | 125 | 5 |
| 63 | 15 | X/7343-43 | T521X156M063A(3)E035 | 94.5 | 10 | 35 | 3,380 | 2,000 | 3 | 125 | 5 |
| 63 | 15 | X/7343-43 | T521X156M063A(3)E150 | 94.5 | 10 | 150 | 1,630 | 2,000 | 3 | 125 | 5 |
| 63 | 18 | X/7343-43 | T521X186M063A(3)E100 | 113.4 | 10 | 100 | 2,000 | 2,000 | 3 | 125 | 6 |
| 63 | 22 | X/7343-43 | T521X226M063A(3)E075 | 138.6 | 10 | 75 | 2,310 | 2,000 | 3 | 125 | 5 |
| 75 | 4.7 | D/7343-31 | T521D475M075A(3)E075 | 35.3 | 10 | 75 | 2,050 | 2,000 | 3 | 125 | 5 |
| 75 | 10 | X/7343-43 | T521X106M075A(3)E050 | 75 | 10 | 50 | 2,830 | 2,000 | 3 | 125 | 5 |
| 75 | 15 | X/7343-43 | T521X156M075A(3)E035 | 112.5 | 10 | 35 | 3,380 | 2,000 | 3 | 125 | 5 |
| 75 | 18 | X/7343-43 | T521X186M075A(3)E100 | 135.0 | 10 | 100 | 2,000 | 2,000 | 3 | 125 | 6 |
| 75 | 22 | X/7343-43 | T521X226M075A(3)E100 | 163.0 | 10 | 100 | 2,000 | 2,000 | 3 | 125 | 6 |
| VDC at 105°C | µF | KEMET/EIA | (See below for part options) | µA at 25°C Maximum/ 5 Minutes | % at 25°C 120 Hz Maximum | mΩ at 25°C 100 kHz Maximum | mA at +45°C 100 kHz | (Hours) | Reflow Temp ≤ 260°C | °C | |
| Rated Voltage | Rated Capacitance | Case Code/ Case Size | KEMET Part Number | DC Leakage | DF | ESR | Maximum Allowable Ripple Current | Endurance | MSL | Maximum Operating Temp | Derating Category |

(2) To complete KEMET part number, insert M for ±20% or K for ±10%. Designates Capacitance tolerance.

(3) To complete KEMET part number, insert T = 100% Matte Tin (Sn)-plated or H = Standard Solder coated (SnPb 5% Pb minimum). Refer to Ordering Information for additional detail.

Higher voltage ratings and tighter ESR may be substituted within the same size at KEMET's option. Voltage substitutions will be marked with the higher voltage rating. Substitutions can include better than series.

Part numbers marked in blue font are not recommended for new designs. Please use the T521 series instead.

^ Denotes the large reel (13") is not available.

* DF measurement condition is 120 Hz/0.5 V_{rms}/1.5 V DC Bias

(1) ESR frequency condition is 300 - 500 kHz

Refer to Ordering Information for additional detail.

Derating Guidelines

Recommended Application Voltage

KO-CAPs are solid state capacitors that demonstrate no wearout mechanism when operated within their recommended guidelines. While the KO-CAP can be operated at full rated voltage, most circuit designers seek a minimum level of assurance in long term reliability, which should be demonstrated with data. A voltage derating can provide the desired level of demonstrated reliability based on industry accepted acceleration models. Since most applications do require long term reliability, KEMET recommends that designers consider a voltage derating, according to the graphic above, for the maximum steady state voltage.

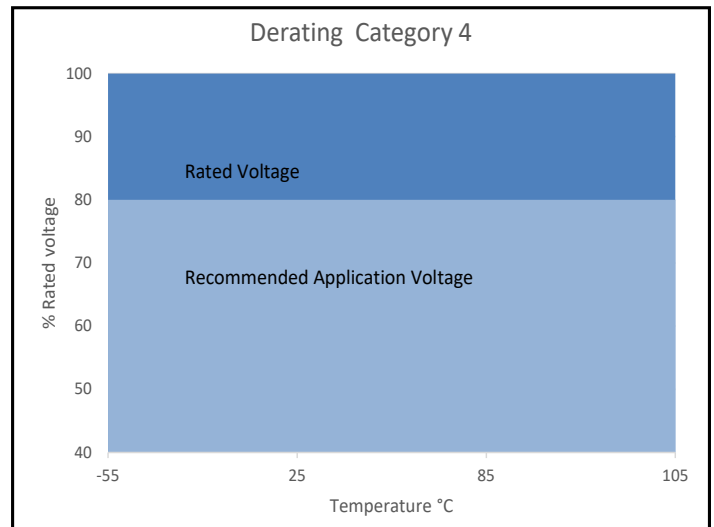
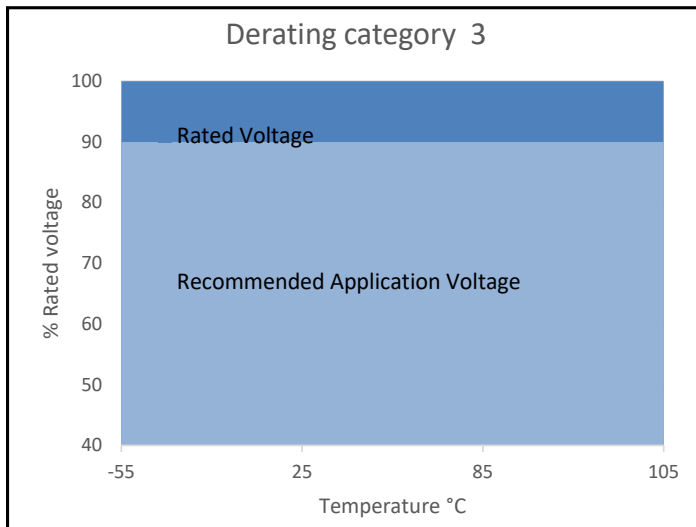
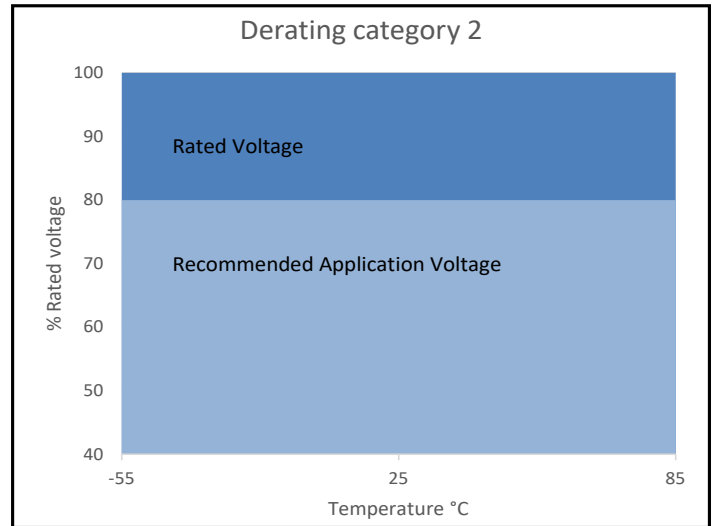
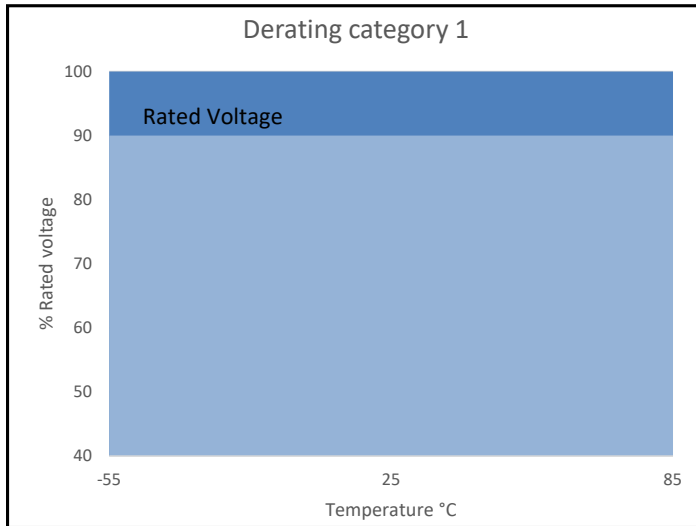

Derating Guidelines cont.

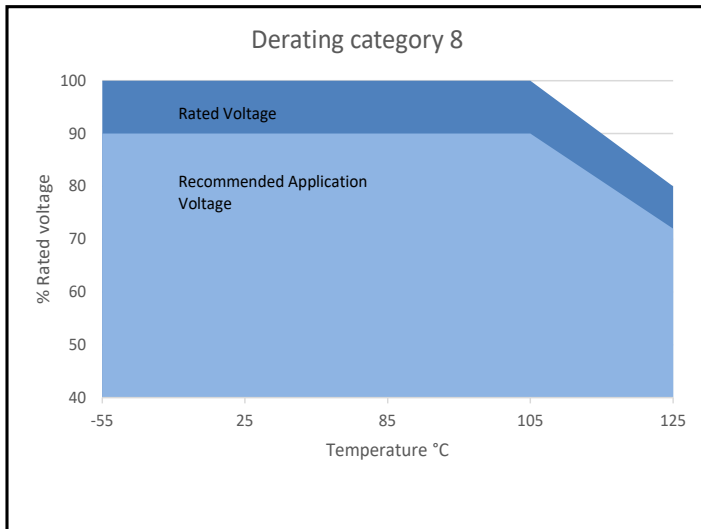
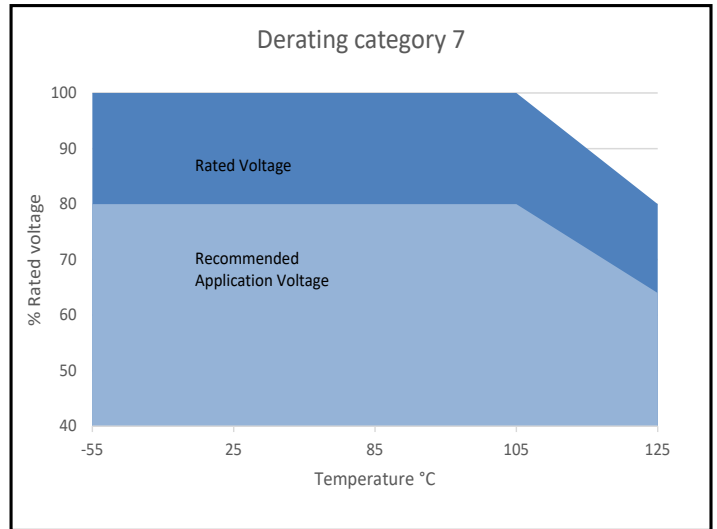
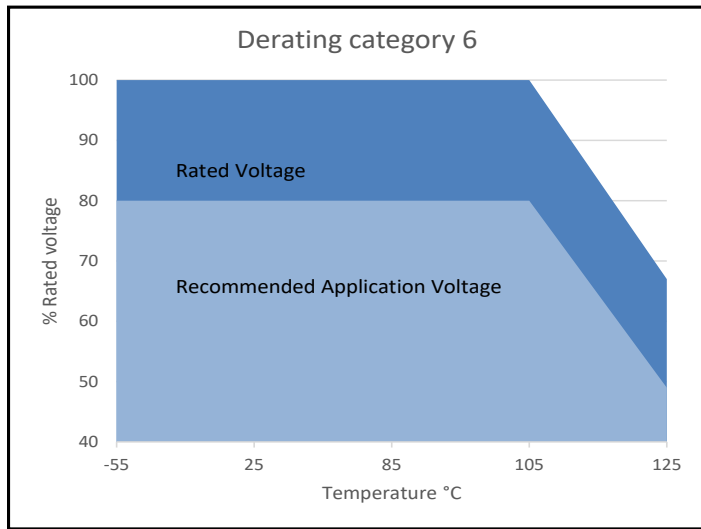
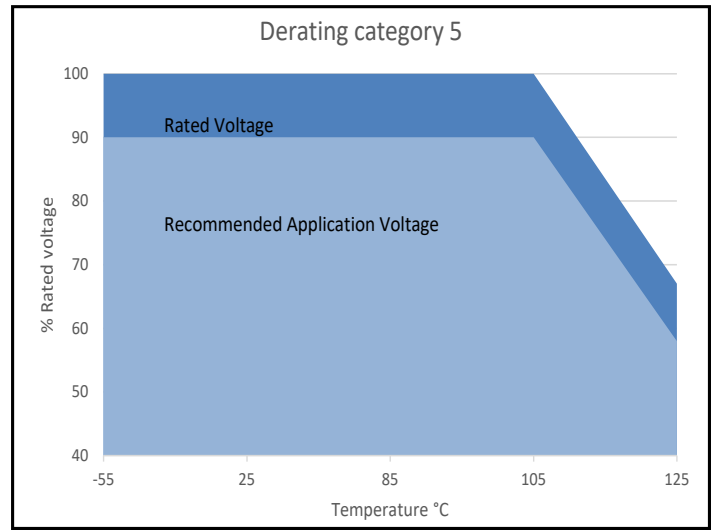
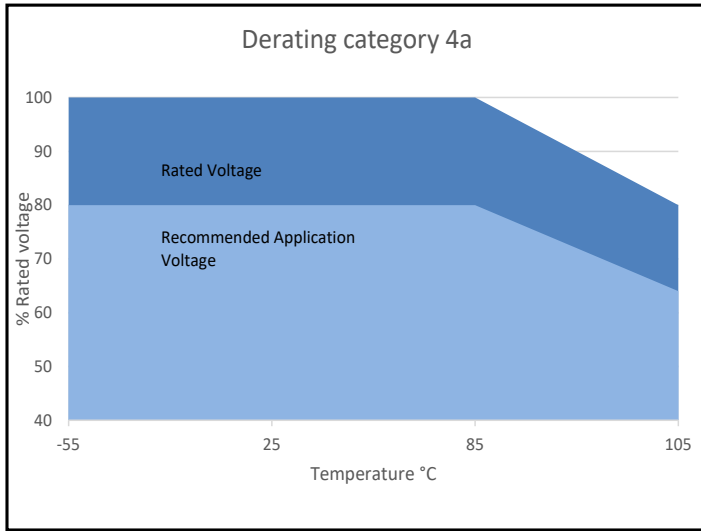

Ripple Current/Ripple Voltage

Permissible AC ripple voltage and current are related to equivalent series resistance (ESR) and the power dissipation capabilities of the device.

Permissible AC ripple voltage which may be applied is limited by two criteria:

- The positive peak AC voltage plus the DC bias voltage, if any, must not exceed the DC voltage rating of the capacitor.
- The negative peak AC voltage, in combination with bias voltage, if any, must not exceed the allowable limits specified for reverse voltage.

The maximum power dissipation by case size can be determined using the below table.

| Temperature Compensation Multipliers for Maximum Ripple Current | | | | |
|---|------------------|-----------------|------------------|-------------------|
| Max Operational Temperature (Series) | -55°C < T ≤ 45°C | 45°C < T ≤ 85°C | 85°C < T ≤ 105°C | 105°C < T ≤ 125°C |
| 85°C (T520, T523) | 1.00 | 0.7 | | |
| 105°C (T520, T521, T523, T527, T529, TF) | 1.00 | 0.7 | 0.25 | |
| 125°C (T525, T530) | 1.00 | 0.7 | 0.25 | 0.25 |
| 125°C dedicated to T521 | 1.00 | 1.00 | 0.70 | 0.25 |

T = Environmental Temperature

Using the P max of the device, the maximum allowable rms ripple current or voltage may be determined.

$$I(max) = \sqrt{P_{max}/R}$$

$$E(max) = Z \sqrt{P_{max}/R}$$

I = RMS ripple current (amperes)

E = RMS ripple voltage (volts)

Pmax = maximum power dissipation (watts)

R = ESR at specified frequency (ohms)

Z = Impedance at specified frequency (ohms)

Refer to part number listings for permissible Arms limits.

Ripple Current/Ripple Voltage cont.

| Maximum Power Dissipation (Pmax) mWatts at 45°C with +30°C Rise | | | | | | |
|---|---------------|-----------|------|------|-----------|------|
| Case Code | EIA Case Code | T520/T525 | T521 | T523 | T527/T529 | T530 |
| P | 2012 | | | | 25 | |
| I / S | 3216 | | | | 60 | |
| A | 3216-18 | 112 | | | | |
| T | 3528-12 | 105 | 160 | 105 | 75 | |
| M | 3528-15 | 120 | 120 | | | |
| B | 3528-21 | 127 | 200 | | | |
| U | 6032-15 | 135 | | | | |
| L | 6032-19 | 150 | | | | |
| C | 6032-28 | 165 | 220 | | | |
| W | 7343-15 | 180 | 255 | 395 | | |
| V | 7343-20 | 187 | 270 | 423 | | |
| D | 7343-31 | 225 | 315 | | | 255 |
| Q | 7343-12 | 170 | 245 | | | |
| Y | 7343-40 | 241 | | | | 263 |
| X | 7343-43 | 247 | 400 | | | 270 |
| J | 7360-15 | | | 440 | | |
| H | 7360-20 | 187 | | 440 | | |

Surge Voltage

Surge voltage is the maximum voltage (peak value) which may be applied to the capacitor. The surge voltage must not be applied for periodic charging and discharging in course of normal operation and cannot be part of the application voltage. Surge voltage capability is demonstrated by application of 1,000 cycles at operating temperature. The parts are charged through a 33 Ohm resistor for 30 seconds and then discharged through a 33 Ohm resistor for each cycle.

| Rated Voltage (V) | Surge Voltage (V) | Category Voltage (V) | Category Surge Voltage (V) |
|-------------------|-------------------|----------------------|----------------------------|
| -55°C to 105°C | | Up to 125°C | |
| 2 | 2.6 | - | |
| 2.5 | 3.3 | 1.7 | 2.2 |
| 3 | 3.9 | 2.0 | 2.7 |
| 4 | 5.2 | 2.7 | 3.5 |
| 6.3 | 8.2 | 4.2 | 5.5 |
| 8 | 10.4 | 5.4 | 7.1 |
| 10 | 13 | 6.7 | 8.7 |
| 12.5 | 16.25 | - | |
| 16 | 20.8 | 10.7 | 13.9 |
| 18 | 23.4 | --- | |
| 20 | 26 | 13.4 | 17.4 |
| 25 | 32.5 | 16.8 | 21.8 |
| 35 | 45.5 | 23.5 | 30.5 |
| 50 | 65 | 33.5 | 43.6 |
| 63 | 81.9 | 42.2 | 54.9 |
| 75 | 97.5 | 50.3 | 65.3 |

Reverse Voltage

Polymer electrolytic capacitors are polar devices and may be permanently damaged or destroyed if connected in the wrong polarity. These devices will withstand a small degree of transient voltage reversal for short periods as shown in the below table.

| Temperature | Permissible Transient Reverse Voltage |
|-------------|---------------------------------------|
| 25°C | 15% of Rated Voltage |
| 55°C | 10% of Rated Voltage |
| 85°C | 5% of Rated Voltage |
| 105°C | 3% of Rated Voltage |
| 125°C* | 1% of Rated Voltage |

*For series rated to 125°C

Table 2 – Land Dimensions/Courtyard

T520/T521/T525/T530

| KEMET | Metric Size Code | Density Level A: Maximum (Most) Land Protrusion (mm) | | | | | Density Level B: Median (Nominal) Land Protrusion (mm) | | | | | Density Level C: Minimum (Least) Land Protrusion (mm) | | | | |
|----------------|------------------|---|------|------|-------|------|---|------|------|------|------|--|------|------|------|------|
| | | Case | EIA | W | L | S | V1 | V2 | W | L | S | V1 | V2 | W | L | S |
| A | 3216-18 | 1.35 | 2.20 | 0.62 | 6.02 | 2.80 | 1.23 | 1.80 | 0.82 | 4.92 | 2.30 | 1.13 | 1.42 | 0.98 | 4.06 | 2.04 |
| B | 3528-21 | 2.35 | 2.21 | 0.92 | 6.32 | 4.00 | 2.23 | 1.80 | 1.12 | 5.22 | 3.50 | 2.13 | 1.42 | 1.28 | 4.36 | 3.24 |
| C | 6032-28 | 2.35 | 2.77 | 2.37 | 8.92 | 4.50 | 2.23 | 2.37 | 2.57 | 7.82 | 4.00 | 2.13 | 1.99 | 2.73 | 6.96 | 3.74 |
| D | 7343-31 | 2.55 | 2.77 | 3.67 | 10.22 | 5.60 | 2.43 | 2.37 | 3.87 | 9.12 | 5.10 | 2.33 | 1.99 | 4.03 | 8.26 | 4.84 |
| H | 7360-20 | 4.25 | 2.77 | 3.67 | 10.22 | 7.30 | 4.13 | 2.37 | 3.87 | 9.12 | 6.80 | 4.03 | 1.99 | 4.03 | 8.26 | 6.54 |
| L | 6032-19 | 2.35 | 2.77 | 2.37 | 8.92 | 4.50 | 2.23 | 2.37 | 2.57 | 7.82 | 4.00 | 2.13 | 1.99 | 2.73 | 6.96 | 3.74 |
| M | 3528-15 | 2.35 | 2.20 | 0.92 | 6.32 | 4.00 | 2.23 | 1.80 | 1.12 | 5.22 | 3.50 | 2.13 | 1.42 | 1.28 | 4.36 | 3.24 |
| Q | 7343-12 | 2.55 | 2.77 | 3.67 | 10.22 | 5.60 | 2.43 | 2.37 | 3.87 | 9.12 | 5.10 | 2.33 | 1.99 | 4.03 | 8.26 | 4.84 |
| T | 3528-12 | 2.35 | 2.20 | 0.92 | 6.32 | 4.00 | 2.23 | 1.80 | 1.12 | 5.22 | 3.50 | 2.13 | 1.42 | 1.28 | 4.36 | 3.24 |
| U | 6032-15 | 2.35 | 2.77 | 2.37 | 8.92 | 4.50 | 2.23 | 2.37 | 2.57 | 7.82 | 4.00 | 2.13 | 1.99 | 2.73 | 6.96 | 3.74 |
| V | 7343-21 | 2.55 | 2.77 | 3.67 | 10.22 | 5.60 | 2.43 | 2.37 | 3.87 | 9.12 | 5.10 | 2.33 | 1.99 | 4.03 | 8.26 | 4.84 |
| W | 7343-15 | 2.55 | 2.77 | 3.67 | 10.22 | 5.60 | 2.43 | 2.37 | 3.87 | 9.12 | 5.10 | 2.33 | 1.99 | 4.03 | 8.26 | 4.84 |
| X ¹ | 7343-43 | 2.55 | 2.77 | 3.67 | 10.22 | 5.60 | 2.43 | 2.37 | 3.87 | 9.12 | 5.10 | 2.33 | 1.99 | 4.03 | 8.26 | 4.84 |
| Y ¹ | 7343-40 | 2.55 | 2.77 | 3.67 | 10.22 | 5.60 | 2.43 | 2.37 | 3.87 | 9.12 | 5.10 | 2.33 | 1.99 | 4.03 | 8.26 | 4.84 |

Density Level A: For low-density product applications. Recommended for wave solder applications and provides a wider process window for reflow solder processes.

Density Level B: For products with a moderate level of component density. Provides a robust solder attachment condition for reflow solder processes.

Density Level C: For high component density product applications. Before adapting the minimum land pattern variations the user should perform qualification testing based on the conditions outlined in IPC standard 7351 (IPC-7351).

¹ Height of these chips may create problems in wave soldering.

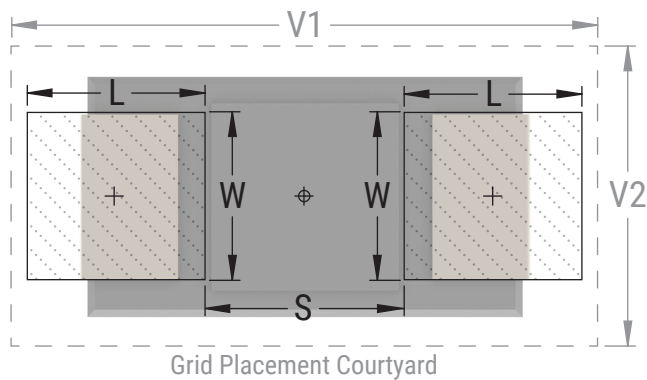
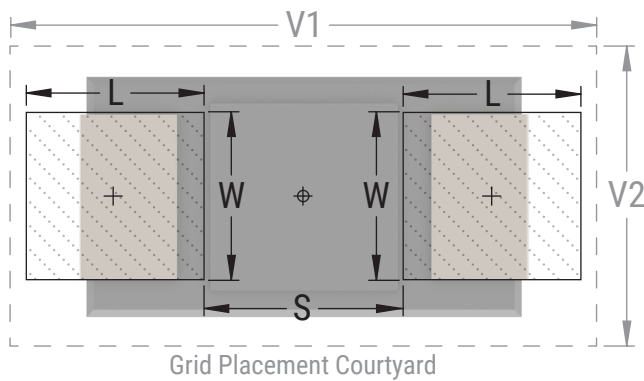

Table 2 – Land Dimensions/Courtyard cont.

T523 / T527

| KEMET | Metric Size Code | Maximum (Most) Land Protrusion (mm) | | | | | Median (Nominal) Land Protrusion (mm) | | | | | Minimum (Least) Land Protrusion (mm) | | | | | |
|-------|------------------|-------------------------------------|------|------|------|-------|---------------------------------------|------|------|------|------|--------------------------------------|------|------|------|------|------|
| | | Case | EIA | W | L | S | V1 | V2 | W | L | S | V1 | V2 | W | L | S | V1 |
| P | 2012-10 | | 1.05 | 1.76 | 0.21 | 4.74 | 2.36 | 0.93 | 1.36 | 0.41 | 3.64 | 1.86 | 0.83 | 0.98 | 0.57 | 2.93 | 1.6 |
| K | 3528-10 | | 2.35 | 2.04 | 1.24 | 6.32 | 4.00 | 2.23 | 1.64 | 1.44 | 5.22 | 3.50 | 2.13 | 1.26 | 1.60 | 4.52 | 3.24 |
| W | 7343-15 | | 2.55 | 2.77 | 3.67 | 10.22 | 5.60 | 2.43 | 2.37 | 3.87 | 9.12 | 5.10 | 2.33 | 1.99 | 4.03 | 8.26 | 4.84 |
| V | 7343-20 | | 2.55 | 2.77 | 3.67 | 10.22 | 5.60 | 2.43 | 2.37 | 3.87 | 9.12 | 5.10 | 2.33 | 1.99 | 4.03 | 8.26 | 4.84 |
| G | 7360-12 | | 4.60 | 3.07 | 3.07 | 10.22 | 7.30 | 4.48 | 2.67 | 3.27 | 9.12 | 6.80 | 4.38 | 2.29 | 3.43 | 8.26 | 6.54 |
| J | 7360-15 | | 4.60 | 3.07 | 3.07 | 10.22 | 7.30 | 4.48 | 2.67 | 3.27 | 9.12 | 6.80 | 4.38 | 2.29 | 3.43 | 8.26 | 6.54 |
| H | 7360-20 | | 4.60 | 3.07 | 3.07 | 10.22 | 7.30 | 4.48 | 2.67 | 3.27 | 9.12 | 6.80 | 4.38 | 2.29 | 3.43 | 8.26 | 6.54 |



T527 / T529

| KEMET | Metric Size Code | Dimensions (mm) | | | |
|-------|------------------|-------------------|-------------|-------------|-------------|
| | | Minimum – Maximum | | | |
| Case | EIA | G | Z | X | Y |
| A08 | 3216-08 | 1.00 – 1.65 | 3.25 – 3.80 | 1.1 – 1.30 | 0.8 – 1.40 |
| I | 3216-10 | 1.00 – 1.65 | 3.25 – 3.80 | 1.10 – 1.30 | 0.80 – 1.40 |
| S | 3216-12 | 1.00 – 1.65 | 3.25 – 3.80 | 1.1 – 1.30 | 0.8 – 1.40 |
| P | 2012-10 | 0.40 – 1.05 | 2.05 – 2.60 | 0.80 – 1.00 | 0.5 – 1.1 |

(JEITA RC-2371 is recommended for reference)

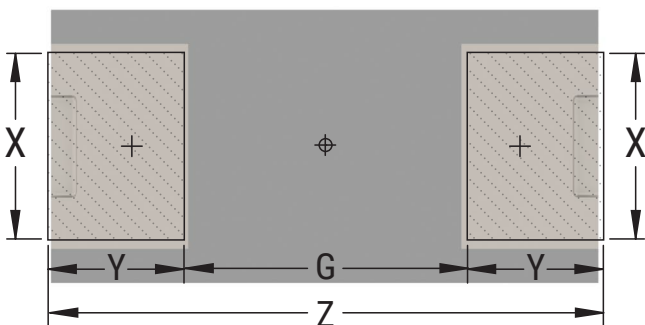

Soldering Process

The KEMET families of surface mount capacitors are compatible with wave (single or dual), convection, IR, or vapor phase reflow techniques. Preheating of these components is recommended to avoid extreme thermal stress. KEMET's recommended profile conditions for convection and IR reflow reflect the profile conditions of the IPC/J-STD-020D standard for moisture sensitivity testing. The devices can safely withstand a maximum of three reflow passes at these conditions.

Please note that although the X/7343-43 case size can withstand wave soldering, the tall profile (4.3 mm maximum) dictates care in wave process development.

Hand soldering should be performed with care due to the difficulty in process control. If performed, care should be taken to avoid contact of the soldering iron to the molded case. The iron should be used to heat the solder pad, applying solder between the pad and the termination, until reflow occurs. Once reflow occurs, the iron should be removed immediately. "Wiping" the edges of a chip and heating the top surface is not recommended.

| Profile Feature | SnPb Assembly | Pb-Free Assembly |
|---|---------------------|---------------------|
| Preheat/Soak | | |
| Temperature Minimum (T_{smin}) | 100°C | 150°C |
| Temperature Maximum (T_{smax}) | 150°C | 200°C |
| Time (t_s) from T_{smin} to T_{smax} | 60 – 120 seconds | 60 – 120 seconds |
| Ramp-up Rate (T_L to T_P) | 3°C/seconds maximum | 3°C/seconds maximum |
| Liquidous Temperature (T_L) | 183°C | 217°C |
| Time Above Liquidous (t_L) | 60 – 150 seconds | 60 – 150 seconds |
| Peak Temperature (T_P) | 220°C* 235°C** | 250°C* 260°C** |
| Time within 5°C of Maximum Peak Temperature (t_p) | 20 seconds maximum | 30 seconds maximum |
| Ramp-down Rate (T_P to T_L) | 6°C/seconds maximum | 6°C/seconds maximum |
| Time 25°C to Peak Temperature | 6 minutes maximum | 8 minutes maximum |

Note: All temperatures refer to the center of the package, measured on the package body surface that is facing up during assembly reflow.

* For Case Size height > 2.5 mm

** For Case Size height ≤ 2.5 mm

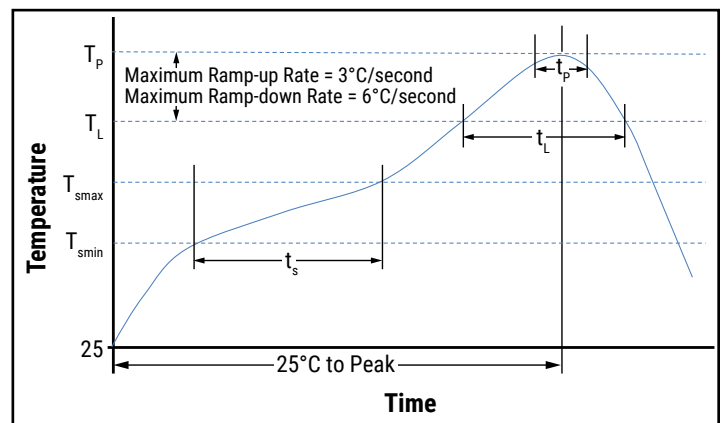

Storage

All KO-Cap are shipped in moisture barrier bags (MBBs) with desiccant and humidity indicator card (HIC).

These parts are classified as moisture sensitivity level 3 (MSL3) or moisture sensitivity level 4 (MSL4) per IPC/JEDEC J-STD-020 and packaged per IPC/JEDEC J-STD-033. Refer to Table 1 for part type specification.

MSL3 specifies a floor time of 168H at 30°C maximum temperature and 60% relative humidity.

MSL4 specifies a floor time of 72H at 30°C maximum temperature and 60% relative humidity. Unused capacitors should be sealed in a MBB with fresh desiccant.

Calculated shelf life in sealed bag:

- 12 months from bag seal date in a storage environment of < 40°C and humidity < 90% RH

- 24 months from bag seal date in a storage environment of < 30°C and humidity < 70% RH

If baking is required, refer to IPC/JEDEC J-STD-033 for bake procedure

Construction

T52X/T530

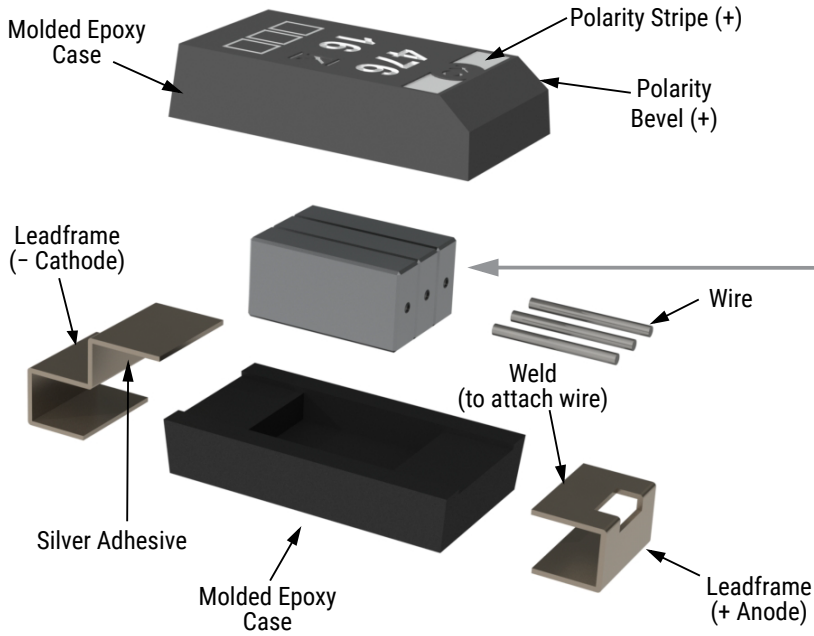

Detailed Cross Section

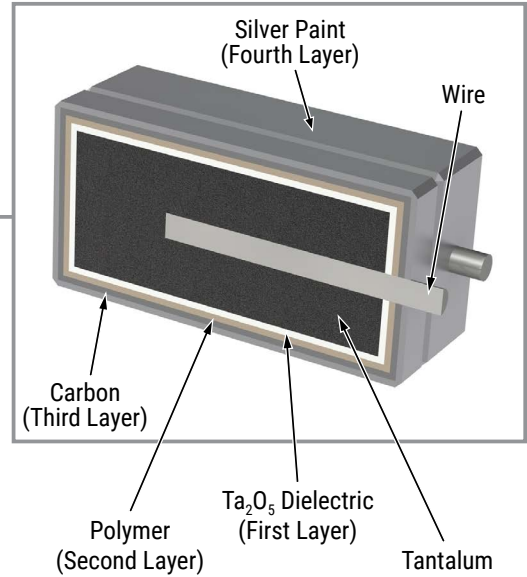

T520/T521/T525

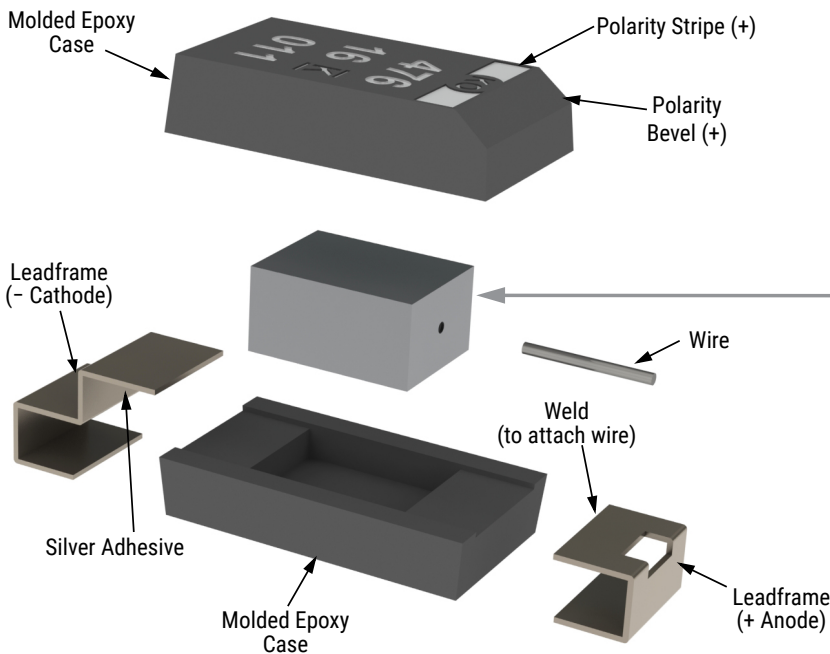

Detailed Cross Section

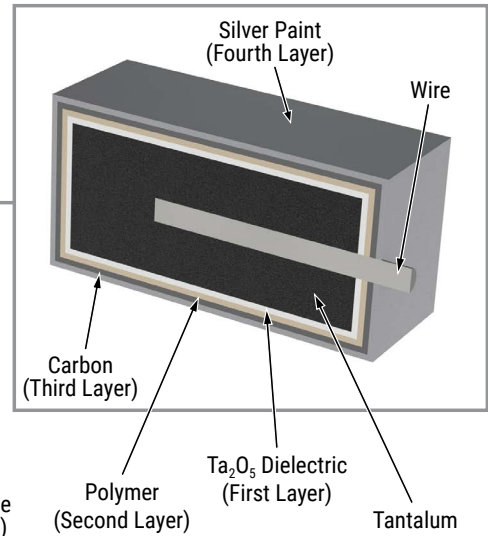

Construction cont.

T523

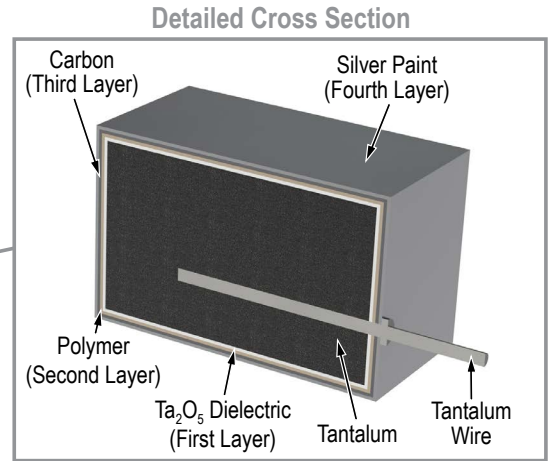
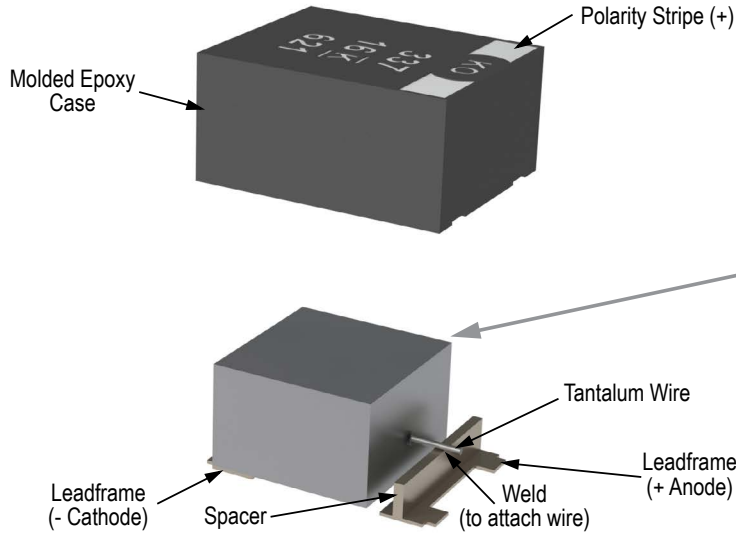

T527

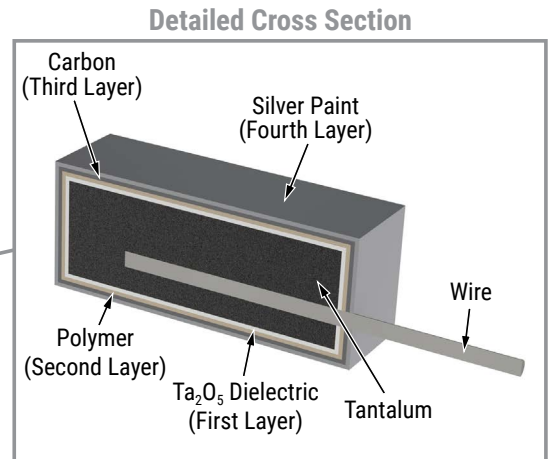
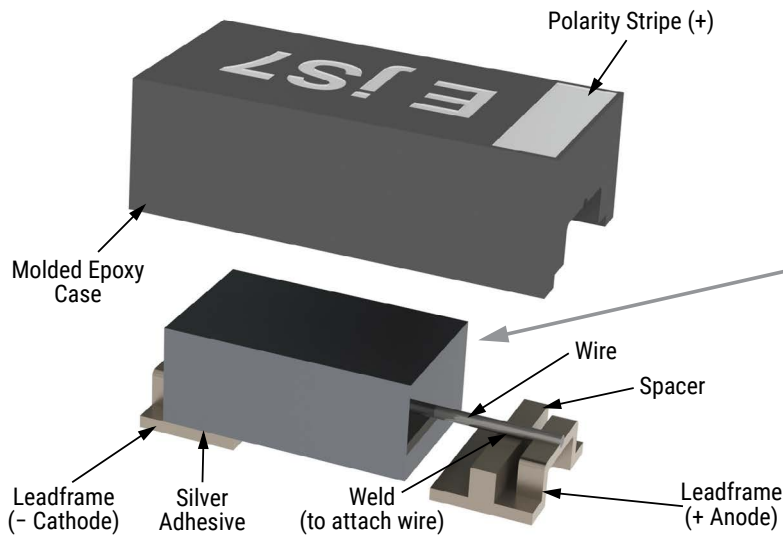

Construction cont.

T529

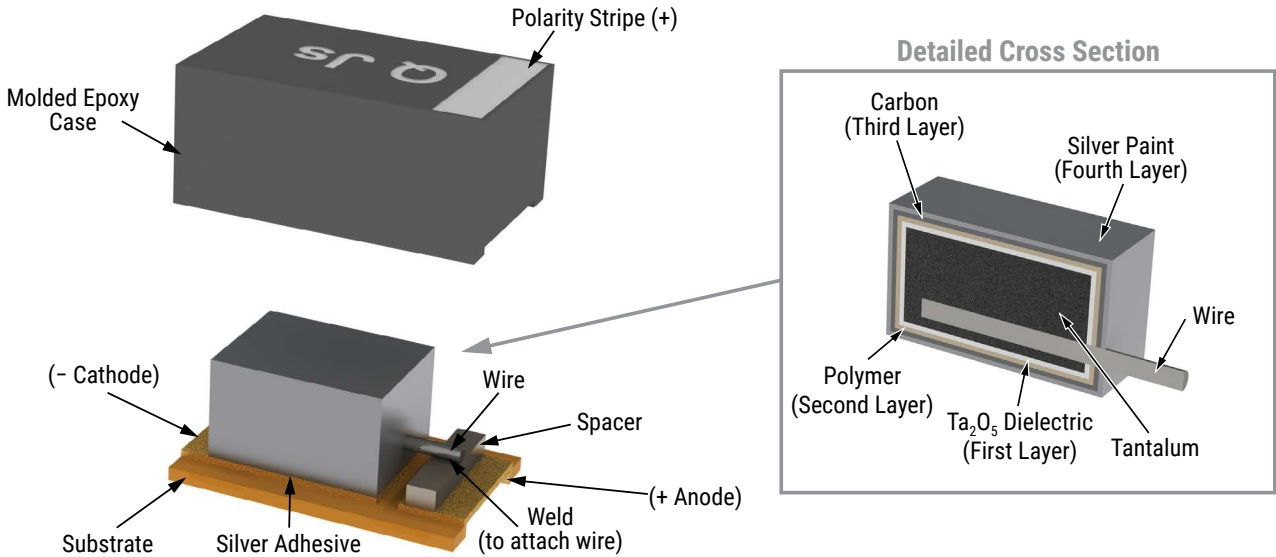

Capacitor Marking

T520/T521/T523/T525/T530

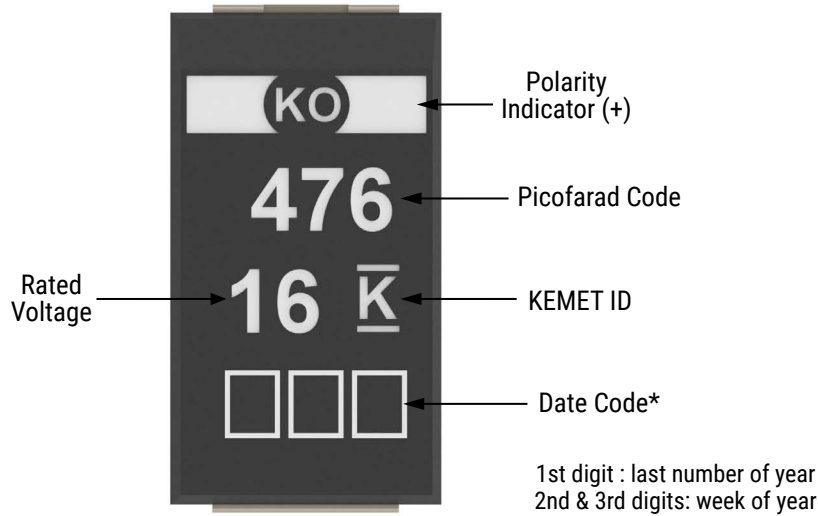

T520A/T527I/T527S/T527T

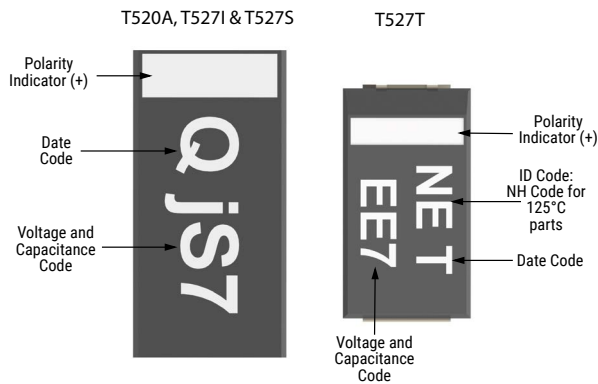

| Code | e | g | j | A | C | E |
|---------------|-------|-----|-------|------|------|------|
| Rated Voltage | 2.5 V | 4 V | 6.3 V | 10 V | 16 V | 25 V |

| Code | A7 | E7 | J7 | N7 | S7 |
|-------------|----|----|----|----|----|
| Capacitance | 10 | 15 | 22 | 33 | 47 |

| Code | W7 | A8 | J8 | N8 |
|-------------|----|-----|-----|-----|
| Capacitance | 68 | 100 | 220 | 330 |

| Date Code* | | | | | | | | | | | | |
|------------|-----|-----|-----|-----|-----|-----|-----|-----|-----|-----|-----|-----|
| Year | Jan | Feb | Mar | Apr | May | Jun | Jul | Aug | Sep | Oct | Nov | Dec |
| 2022 | N | P | Q | R | S | T | U | V | W | X | Y | Z |
| 2023 | a | b | c | d | e | f | g | h | j | k | l | m |
| 2024 | n | p | q | r | s | t | u | v | w | x | y | z |
| 2025 | A | B | C | D | E | F | G | H | J | K | L | M |
| 2026 | N | P | Q | R | S | T | U | V | W | X | Y | Z |

Capacitor Marking cont.

T520B/T521B/T520T

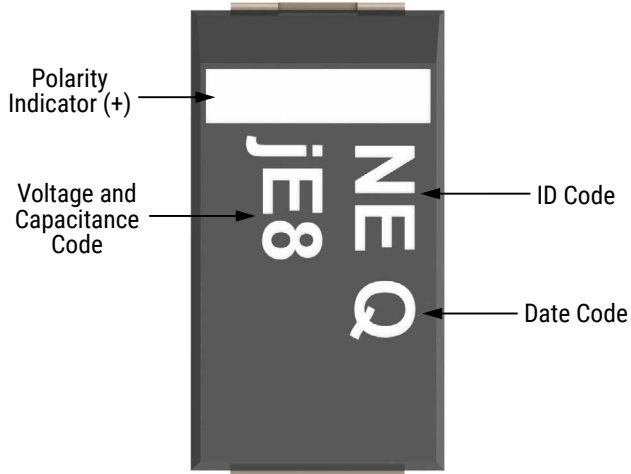

| Code | e | g | J | A | C | D | E |
|---------------|-------|-----|-------|------|------|------|------|
| Rated Voltage | 2.5 V | 4 V | 6.3 V | 10 V | 16 V | 20 V | 25 V |

| Code | E7 | J7 | N7 | A8 |
|-------------|----|----|----|-----|
| Capacitance | 15 | 22 | 33 | 100 |

| Code | E8 | J8 | N8 | S8 |
|-------------|-----|-----|-----|-----|
| Capacitance | 150 | 220 | 330 | 470 |

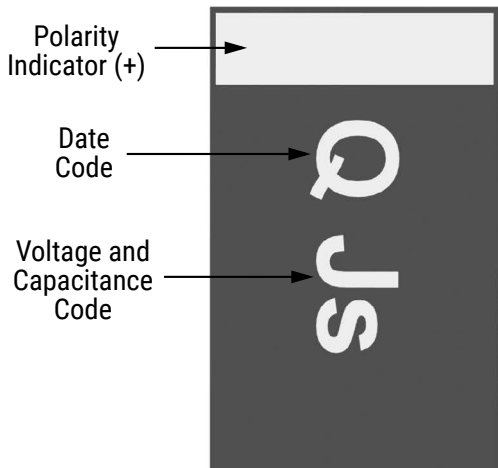

T529

| Code | J | A | C | E |
|---------------|-------|------|------|------|
| Rated Voltage | 6.3 V | 10 V | 16 V | 25 V |

| Code | S | a | j | s |
|------------------|-----|----|----|----|
| Capacitance (µF) | 4.7 | 10 | 22 | 47 |

Tape & Reel Packaging Information

KEMET's molded chip capacitor families are packaged in 8 and 12 mm plastic tape on 7" and 13" reels in accordance with *EIA Standard 481: Embossed Carrier Taping of Surface Mount Components for Automatic Handling*. This packaging system is compatible with all tape-fed automatic pick-and-place systems.

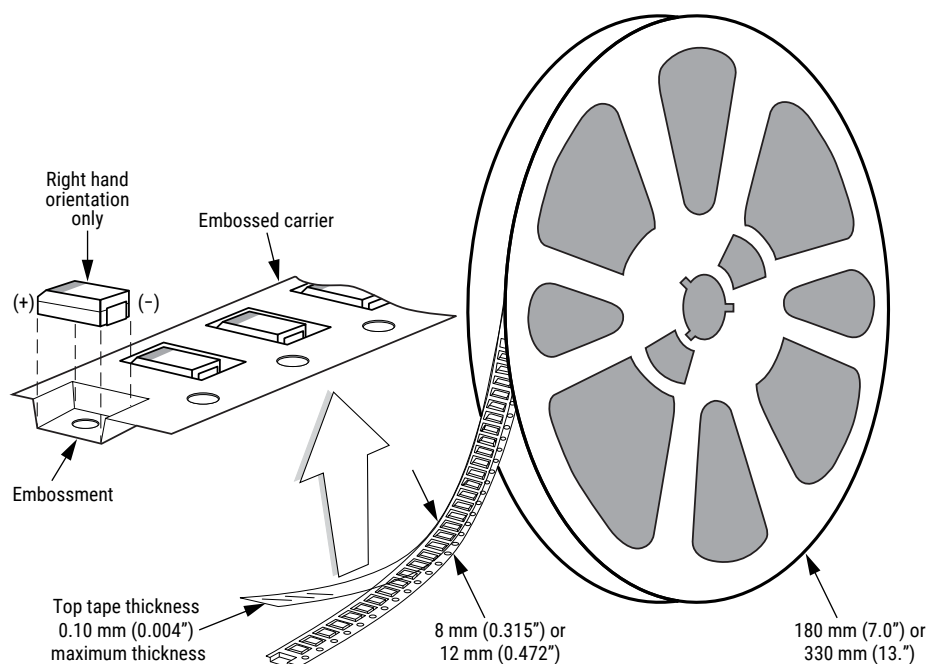

Table 3 – Packaging Quantity

| Case Code | | Tape Width (mm) | 7" Reel* | 13" Reel* |
|-----------|---------|-----------------|----------|-----------|
| KEMET | EIA | | | |
| P | 2012-10 | 8 | 3,000 | N/A |
| R | 2012-12 | 8 | 2,500 | 10,000 |
| 08A | 3216-08 | 8 | 3,000 | N/A |
| I | 3216-10 | 8 | 3,000 | N/A |
| S | 3216-12 | 8 | 3,000 | N/A |
| A | 3216-18 | 8 | 2,000 | N/A |
| K | 3528-10 | 8 | 3,000 | N/A |
| T | 3528-12 | 8 | 3,000 | 10,000 |
| M | 3528-15 | 8 | 2,500 | 8,000 |
| B | 3528-21 | 8 | 2,000 | 8,000 |
| U | 6032-15 | 12 | 1,000 | 5,000 |
| L | 6032-19 | 12 | 1,000 | 3,000 |
| C | 6032-28 | 12 | 500 | 3,000 |
| Q | 7343-12 | 12 | 1,000 | 3,000 |
| W | 7343-15 | 12 | 1,000 | 3,000 |
| Z | 7343-17 | 12 | 1,000 | 3,000 |
| V | 7343-19 | 12 | 1,000 | 3,000 |
| D | 7343-31 | 12 | 500 | 2,500 |
| Y | 7343-40 | 12 | 500 | 2,000 |
| X | 7343-43 | 12 | 500 | 2,000 |
| J | 7360-15 | 12 | 1,000 | 3,000 |
| H | 7360-20 | 12 | 1,000 | 3,000 |
| O | 7360-43 | 12 | 250 | 1,000 |

* No Co-Spec required for 7" reel packaging. C-7280 required for 13" reel packaging.

Figure 1 – Embossed (Plastic) Carrier Tape Dimensions

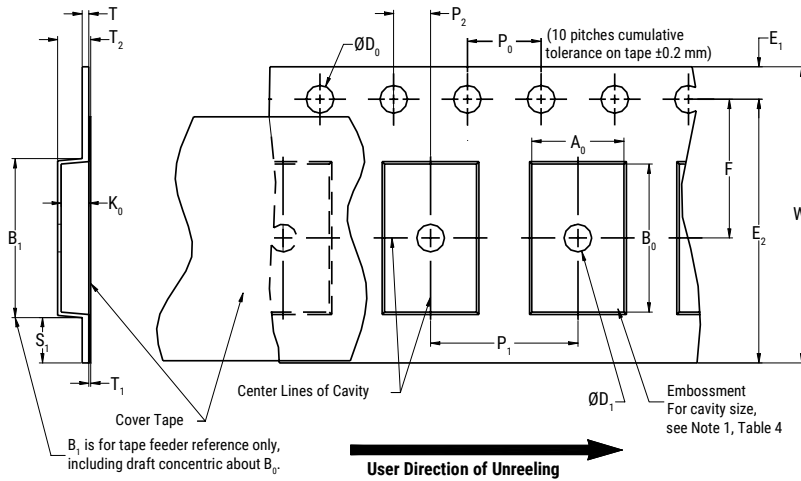

Table 4 – Embossed (Plastic) Carrier Tape Dimensions

Metric will govern

| Constant Dimensions – Millimeters (Inches) | | | | | | | | | |
|--|---|-------------------------|--|---|---|-----------------------|-------------------------|--------------------|------------------|
| Tape Size | D_0 | D_1 Minimum Note 1 | E_1 | P_0 | P_2 | R Reference Note 2 | S_1 Minimum Note 3 | T Maximum | T_1 Maximum |
| 8 mm | $1.5 +0.10/-0.0$ ($0.059 +0.004/-0.0$) | 1.0 (0.039) | 1.75 ± 0.10 (0.069 ± 0.004) | 4.0 ± 0.10 (0.157 ± 0.004) | 2.0 ± 0.05 (0.079 ± 0.002) | 25.0 (0.984) | 0.600 (0.024) | 0.600 (0.024) | 0.100 (0.004) |
| 12 mm | | 1.5 (0.059) | | | | | | | |
| Variable Dimensions – Millimeters (Inches) | | | | | | | | | |
| Tape Size | Pitch | B_1 Maximum Note 4 | E_2 Minimum | F | P_1 | T_2 Maximum | W Maximum | A_0, B_0 & K_0 | |
| 8 mm | Single (4 mm) | 4.35 (0.171) | 6.25 (0.246) | 3.5 ± 0.05 (0.138 ± 0.002) | 4.0 ± 0.10 (0.157 ± 0.004) | 2.5 (0.098) | 8.3 (0.327) | Note 5 | |
| 12 mm | Single (4 mm) and Double (8 mm) | 8.2 (0.323) | 10.25 (0.404) | 5.5 ± 0.05 (0.217 ± 0.002) | 8.0 ± 0.10 (0.315 ± 0.004) | 4.6 (0.181) | 12.3 (0.484) | | |

1. The embossment hole location shall be measured from the sprocket hole controlling the location of the embossment. Dimensions of embossment location and hole location shall be applied independent of each other.
2. The tape, with or without components, shall pass around R without damage (see Figure 4).
3. If $S_1 < 1.0$ mm, there may not be enough area for cover tape to be properly applied (see EIA Standard 481-D, paragraph 4.3, section b).
4. B_1 dimension is a reference dimension for tape feeder clearance only.
5. The cavity defined by A_0 , B_0 and K_0 shall surround the component with sufficient clearance that:
 - (a) the component does not protrude above the top surface of the carrier tape.
 - (b) the component can be removed from the cavity in a vertical direction without mechanical restriction, after the top cover tape has been removed.
 - (c) rotation of the component is limited to 20° maximum for 8 and 12 mm tapes (see Figure 2).
 - (d) lateral movement of the component is restricted to 0.5 mm maximum for 8 mm and 12 mm wide tape (see Figure 3).
 - (e) see Addendum in EIA Standard 481-D for standards relating to more precise taping requirements.

Packaging Information Performance Notes

- 1. Cover Tape Break Force:** 1.0 Kg minimum.
- 2. Cover Tape Peel Strength:** The total peel strength of the cover tape from the carrier tape shall be:

| Tape Width | Peel Strength |
|------------|----------------------------------|
| 8 mm | 0.1 to 1.0 Newton (10 to 100 gf) |
| 12 mm | 0.1 to 1.3 Newton (10 to 130 gf) |

The direction of the pull shall be opposite the direction of the carrier tape travel. The pull angle of the carrier tape shall be 165° to 180° from the plane of the carrier tape. During peeling, the carrier and/or cover tape shall be pulled at a velocity of 300 ±10 mm/minute.

- 3. Labeling:** Bar code labeling (standard or custom) shall be on the side of the reel opposite the sprocket holes. Refer to EIA Standards 556 and 624.

Figure 2 – Maximum Component Rotation

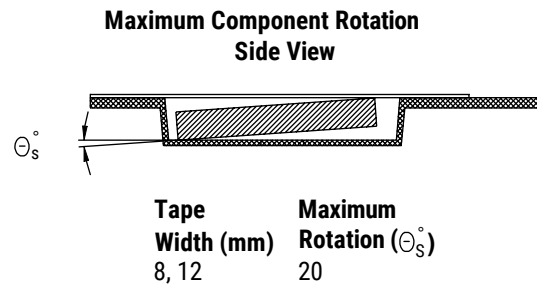
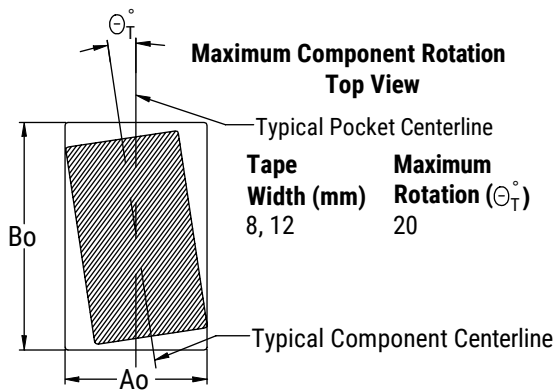

Figure 3 – Maximum Lateral Movement

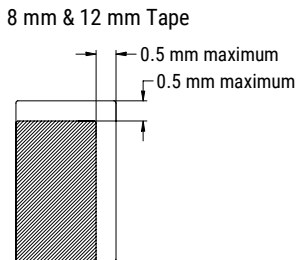

Figure 4 – Bending Radius

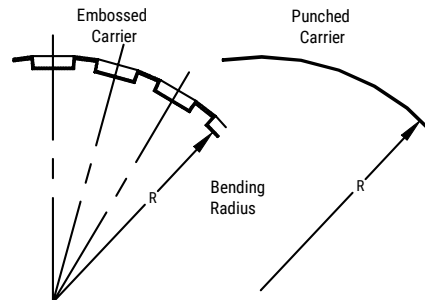

Figure 5 – Reel Dimensions

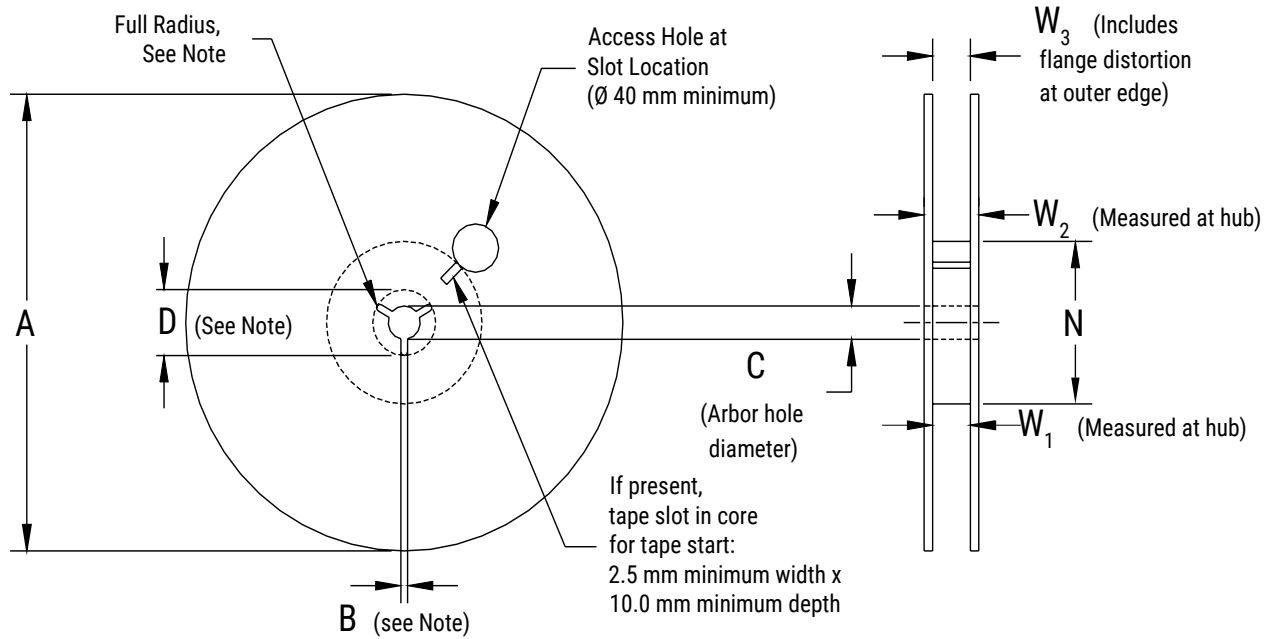

Table 5 – Reel Dimensions

Metric will govern

| Constant Dimensions – Millimeters (Inches) | | | | |
|--|------------------------------|---------------------------------------|--|---|
| Tape Size | A | B Minimum | C | D Minimum |
| 8 mm | 178 ±0.20 (7.008 ±0.008) | 1.5 (0.059) | 13.0 +0.5/-0.2 (0.521 +0.02/-0.008) | 20.2 (0.795) |
| 12 mm | 330 ±0.20 (13.000 ±0.008) | | | |
| Variable Dimensions – Millimeters (Inches) | | | | |
| Tape Size | N Minimum | W ₁ | W ₂ Maximum | W ₃ |
| 8 mm | 50 (1.969) | 8.4 +1.5/-0.0 (0.331 +0.059/-0.0) | 14.4 (0.567) | Shall accommodate tape width without interference |
| 12 mm | | 12.4 +2.0/-0.0 (0.488 +0.078/-0.0) | 18.4 (0.724) | |

Figure 6 – Tape Leader & Trailer Dimensions

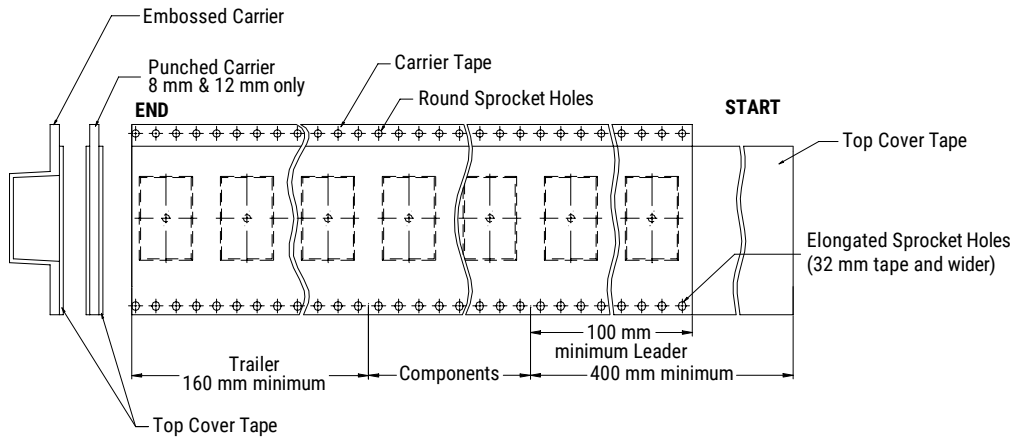
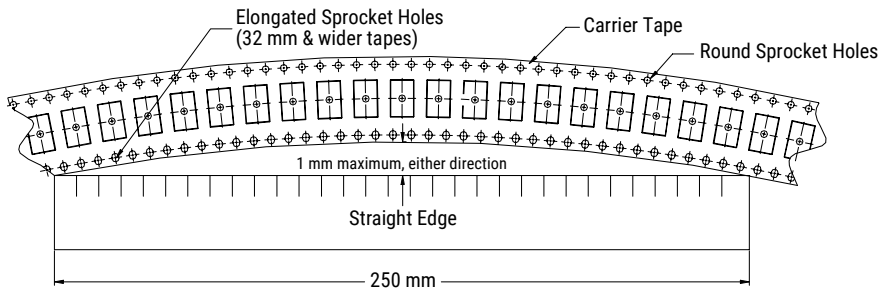

Figure 7 – Maximum Camber



KEMET Electronics Corporation Sales Offices

For a complete list of our global sales offices, please visit <https://www.yageogroup.com/SalesResources/SalesOffices>

Disclaimer

YAGEO Corporation and its affiliates do not recommend the use of commercial or automotive grade products for high reliability applications or manned space flight.

All product specifications, statements, information and data (collectively, the "Information") in this datasheet are subject to change. The customer is responsible for checking and verifying the extent to which the Information contained in this publication is applicable to an order at the time the order is placed. All Information given herein is believed to be accurate and reliable, but it is presented without guarantee, warranty, or responsibility of any kind, expressed or implied.

Statements of suitability for certain applications are based on KEMET Electronics Corporation's ("KEMET") knowledge of typical operating conditions for such applications, but are not intended to constitute – and KEMET specifically disclaims – any warranty concerning suitability for a specific customer application or use. The Information is intended for use only by customers who have the requisite experience and capability to determine the correct products for their application. Any technical advice inferred from this Information or otherwise provided by KEMET with reference to the use of KEMET's products is given gratis, and KEMET assumes no obligation or liability for the advice given or results obtained.

Although KEMET designs and manufactures its products to the most stringent quality and safety standards, given the current state of the art, isolated component failures may still occur. Accordingly, customer applications which require a high degree of reliability or safety should employ suitable designs or other safeguards (such as installation of protective circuitry or redundancies) in order to ensure that the failure of an electrical component does not result in a risk of personal injury or property damage.

Although all product-related warnings, cautions and notes must be observed, the customer should not assume that all safety measures are indicated or that other measures may not be required.

KEMET is a registered trademark of KEMET Electronics Corporation.