

600 W TVS in SMB

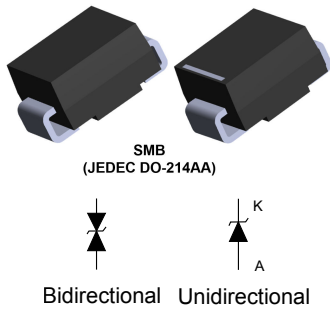

Features

- Peak pulse power: 600 W (10/1000 μ s) and 4 kW (8/20 μ s)
- Stand-off voltage range from 5 V to 188 V
- Unidirectional and bidirectional types
- Low leakage current: 0.2 μ A at 25 °C and 1 μ A at 85 °C
- Operating T_j max: 150 °C
- High power capability at T_j max.: up to 350 W (10/1000 μ s)
- Lead finishing: matte tin plating

Complies with the following standards

- UL94, V0
- J-STD-020 MSL level 1
- J-STD-002, JESD 22-B102 E3 and MIL-STD-750, method 2026 solderable matte tin plated leads
- JESD-201 class 2 whisker test
- IPC7531 footprint
- JEDEC registered package outline
- IEC 61000-4-4 level 4:
 - 4 kV
- IEC 61000-4-2, C = 150 pF - R = 330 Ω exceeds level 4:
 - 30 kV (air discharge)
 - 30 kV (contact discharge)

Description

The SMBJ series are designed to protect sensitive equipment against electrostatic discharges according to IEC 61000-4-2 and MIL STD 883, method 3015, and electrical overstress according to IEC 61000-4-4 and 5. This device is more generally used against surges below 600 W (10/1000 μ s).

The Planar technology makes it suitable for high-end equipment and SMPS where low leakage current and high junction temperature are required to provide reliability and stability over time.

The SMBJ series are packaged in SMB.

Product status link

Unidirectional	Bidirectional
SMBJ5.0A,	SMBJ5.0CA,
SMBJ6.0A,	SMBJ6.0CA,
SMBJ6.5A,	SMBJ6.5CA,
SMBJ8.5A,	SMBJ8.5CA,
SMBJ10A,	SMBJ10CA,
SMBJ12A,	SMBJ12CA,
SMBJ13A,	SMBJ13CA,
SMBJ15A,	SMBJ15CA,
SMBJ16A,	SMBJ16CA,
SMBJ18A,	SMBJ18CA,
SMBJ20A,	SMBJ20CA,
SMBJ22A,	SMBJ22CA,
SMBJ24A,	SMBJ24CA,
SMBJ26A,	SMBJ26CA,
SMBJ28A,	SMBJ28CA,
SMBJ30A,	SMBJ30CA,
SMBJ33A,	SMBJ33CA,
SMBJ36A,	SMBJ36CA,
SMBJ40A,	SMBJ40CA,
SMBJ43A,	SMBJ43CA,
SMBJ48A,	SMBJ48CA,
SMBJ58A,	SMBJ58CA,
SMBJ64A,	SMBJ64CA,
SMBJ70A,	SMBJ70CA,
SMBJ85A,	SMBJ85CA,
SMBJ100A,	SMBJ100CA,
SMBJ130A,	SMBJ130CA,
SMBJ154A,	SMBJ154CA,
SMBJ170A,	SMBJ170CA,
SMBJ188A,	SMBJ188CA,

1 Characteristics

Table 1. Absolute maximum ratings ($T_{amb} = 25\text{ }^{\circ}\text{C}$)

Symbol	Parameter	Value	Unit	
V_{PP}	Peak pulse voltage	IEC 61000-4-2 (C = 150 pF, R = 330 Ω)		
		Contact discharge	30	kV
		Air discharge	30	
P_{PP}	Peak pulse power dissipation	10/1000 μs , T_j initial = T_{amb}	600	W
T_{stg}	Storage temperature range		-65 to +150	$^{\circ}\text{C}$
T_j	Operating junction temperature range		-55 to +150	$^{\circ}\text{C}$
T_L	Maximum lead temperature for soldering during 10 s		260	$^{\circ}\text{C}$

Figure 1. Electrical characteristics - parameter definitions

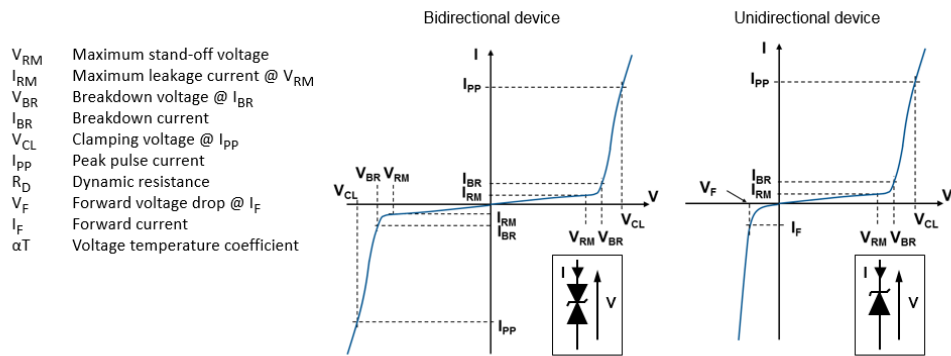

Figure 2. Pulse definition for electrical characteristics

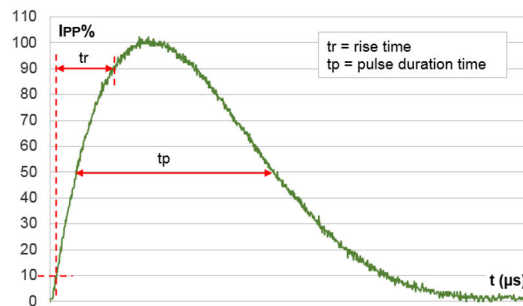

Table 2. Electrical characteristics - parameter values ($T_{amb} = 25\text{ }^{\circ}\text{C}$, unless otherwise specified)

Type	I_{RM} max at V_{RM}			V_{BR} at $I_{BR}^{(1)}$			10 / 1000 μs			8 / 20 μs			αT
							$V_{CL}^{(2)(3)}$	$I_{PP}^{(4)}$	R_D	$V_{CL}^{(2)(3)}$	$I_{PP}^{(4)}$	R_D	
	25 $^{\circ}\text{C}$	85 $^{\circ}\text{C}$		Min.	Typ.		Max.		Max.	Max.		Max.	
	μA		V	V		mA	V	A	Ω	V	A	Ω	$10^{-4}/^{\circ}\text{C}$
SMBJ5.0A/CA	20	50	5.0	6.40	6.74	10	9.2	68	0.031	14.4	275	0.027	5.7
SMBJ6.0A/CA	20	50	6.0	6.70	7.05	10	10.3	61	0.048	14.8	270	0.027	5.9
SMBJ6.5A/CA	20	50	6.5	7.20	7.58	10	11.2	56	0.058	15.2	266	0.027	6.1
SMBJ8.5A/CA	20	50	8.5	9.40	9.90	1	14.4	41.7	0.096	19.5	205	0.044	7.3
SMBJ10A/CA	0.2	1	10	11.1	11.7	1	17	37	0.127	21.7	184	0.051	7.8
SMBJ12A/CA	0.2	1	12	13.3	14.0	1	19.9	31	0.168	25.3	157	0.068	8.3
SMBJ13A/CA	0.2	1	13	14.4	15.2	1	21.5	29	0.191	27.2	147	0.076	8.4
SMBJ15A/CA	0.2	1	15	16.7	17.6	1	24.4	25.1	0.236	32.5	123	0.114	8.8
SMBJ16A/CA	0.2	1	16	17.8	18.7	1	26	23.1	0.276	34.4	116	0.127	8.8
SMBJ18A/CA	0.2	1	18	20.0	21.1	1	29.2	21.5	0.328	39.3	102	0.168	9.2
SMBJ20A/CA	0.2	1	20	22.2	23.4	1	32.4	19.4	0.404	42.8	93	0.196	9.4
SMBJ22A/CA	0.2	1	22	24.4	25.7	1	35.5	17.7	0.481	48.3	83	0.257	9.6
SMBJ24A/CA	0.2	1	24	26.7	28.1	1	38.9	16	0.587	50	80	0.256	9.6
SMBJ26A/CA	0.2	1	26	28.9	30.4	1	42.1	14.9	0.683	53.5	75	0.288	9.7
SMBJ28A/CA	0.2	1	28	31.1	32.7	1	45.4	13.8	0.802	59	68	0.363	9.8
SMBJ30A/CA	0.2	1	30	33.3	35.1	1	48.4	13	0.888	64.3	62	0.443	9.9
SMBJ33A/CA	0.2	1	33	36.7	38.6	1	53.3	11.8	1.08	69.7	57	0.512	10.0
SMBJ36A/CA	0.2	1	36	40.0	42.1	1	58.1	10.3	1.35	76	52	0.611	10.0
SMBJ40A/CA	0.2	1	40	44.4	46.7	1	64.5	9.7	1.59	84	48	0.728	10.1
SMBJ48A/CA	0.2	1	48	53.3	56.1	1	77.4	8.1	2.28	100	40	1.03	10.3
SMBJ58A/CA	0.2	1	58	64.4	67.8	1	93.6	6.7	3.34	121	33	1.51	10.4
SMBJ64A/CA	0.2	1	64	71.3	75	1	103	5.8	4.17	134	30	1.84	10.5
SMBJ70A/CA	0.2	1	70	77.8	81.9	1	113	5.5	4.91	146	27	2.22	10.5
SMBJ85A/CA	0.2	1	85	94	99	1	137	4.6	7.18	178	22.5	3.29	10.6
SMBJ100A/CA	0.2	1	100	111	117	1	162	3.8	10.3	212	19	4.69	10.7
SMBJ130A/CA	0.2	1	130	144	152	1	209	3	16.5	265	15	7.03	10.8
SMBJ154A/CA	0.2	1	154	171	180	1	246	2.4	23.8	317	12.6	10.2	10.8
SMBJ170A/CA	0.2	1	170	189	199	1	275	2.2	30.0	353	11.3	12.7	10.8
SMBJ188A/CA	0.2	1	188	209	220	1	328	2	48.5	388	10.3	15.2	10.8

1. To calculate V_{BR} versus T_j : V_{BR} at $T_j = V_{BR}$ at $25\text{ }^{\circ}\text{C} \times (1 + \alpha T \times (T_j - 25))$
2. To calculate V_{CL} versus T_j : V_{CL} at $T_j = V_{CL}$ at $25\text{ }^{\circ}\text{C} \times (1 + \alpha T \times (T_j - 25))$
3. To calculate V_{CL} max versus $I_{PP_{appli}}$: $V_{CL_{max}} = V_{CL} - R_D \times (I_{PP} - I_{PP_{appli}})$ where $I_{PP_{appli}}$ is the surge current in the application
4. Surge capability given for both directions for unidirectional and bidirectional devices

1.1 Characteristics (curves)

Figure 3. Maximum peak power dissipation versus initial junction temperature

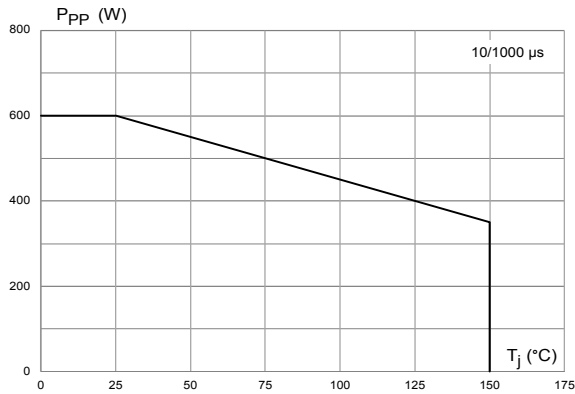

Figure 4. Maximum peak pulse power versus exponential pulse duration

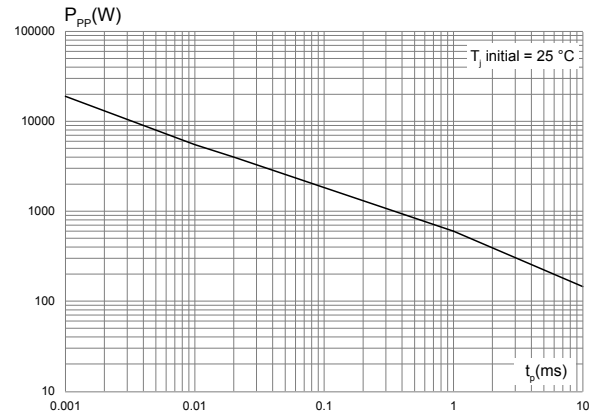

Figure 5. Maximum peak pulse current versus clamping voltage

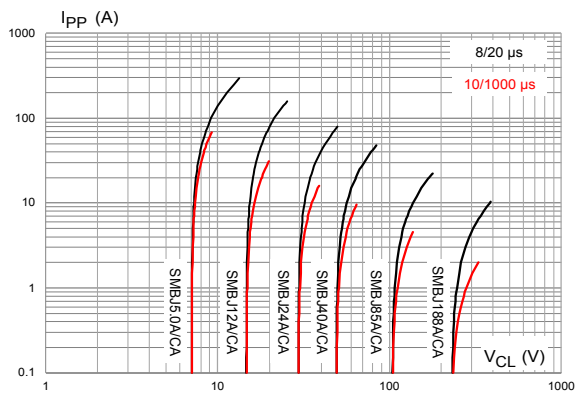

Figure 6. Dynamic resistance versus pulse duration

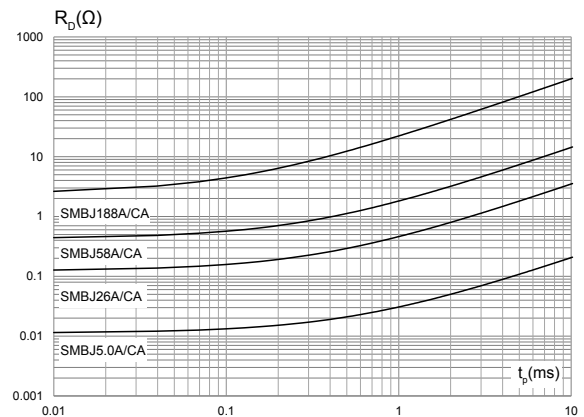

Figure 7. Junction capacitance versus reverse applied voltage (unidirectional type)

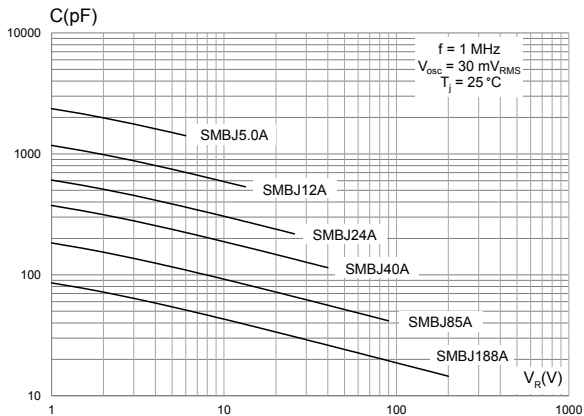

Figure 8. Junction capacitance versus applied voltage (bidirectional type)

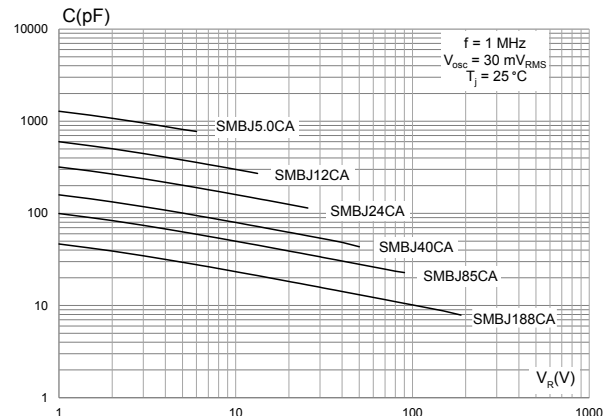

Figure 9. Leakage current versus junction temperature

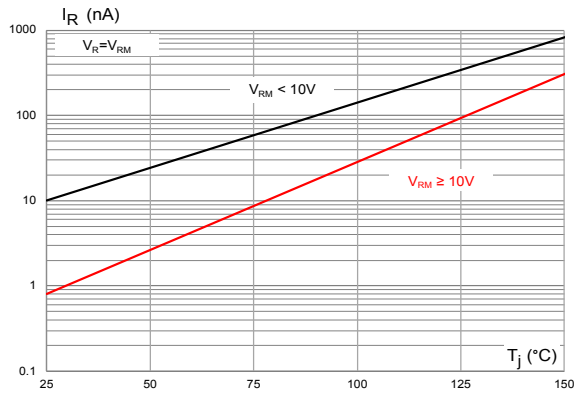

Figure 10. Peak forward voltage drop versus peak forward current

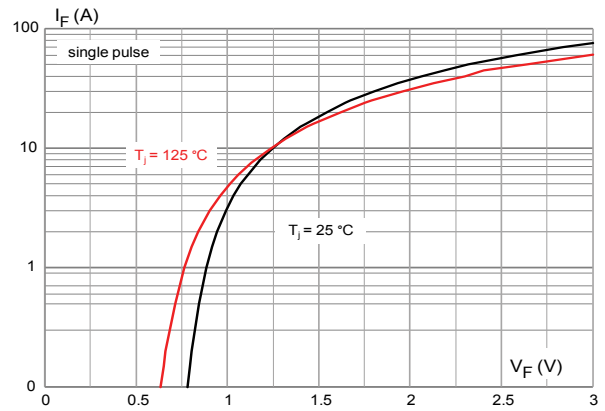

Figure 11. Thermal impedance junction to ambient versus pulse duration

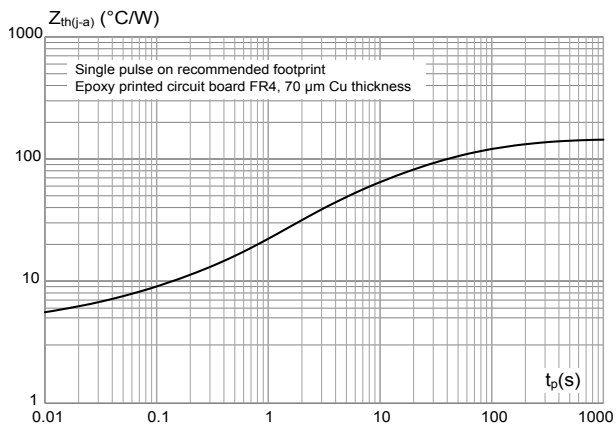
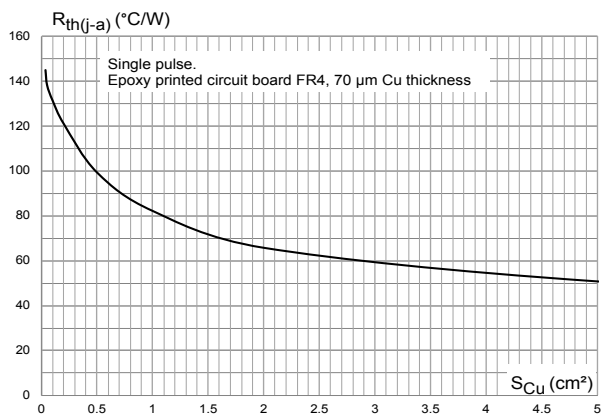

Figure 12. Thermal resistance junction to ambient versus copper area under each lead



2 Package information

To meet environmental requirements, ST offers these devices in different grades of **ECOPACK** packages, depending on their level of environmental compliance. ECOPACK specifications, grade definitions, and product status are available at: www.st.com. ECOPACK is an ST trademark.

2.1 SMB package information

Figure 13. SMB package outline

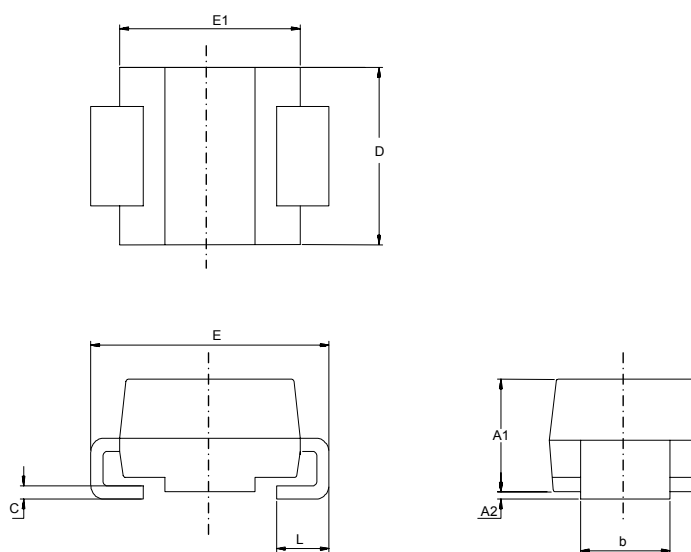

Table 3. SMB package mechanical data

Ref.	Dimensions			
	Millimeters		Inches ⁽¹⁾	
	Min.	Max.	Min.	Max.
A1	1.90	2.45	0.0748	0.0965
A2	0.05	0.20	0.0020	0.0079
b	1.95	2.20	0.0768	0.0867
c	0.15	0.40	0.0059	0.0157
D	3.30	3.95	0.1299	0.1556
E	5.10	5.60	0.2008	0.2205
E1	4.05	4.60	0.1594	0.1811
L	0.75	1.50	0.0295	0.0591

1. Values in inches are converted from mm

Figure 14. SMB recommended footprint

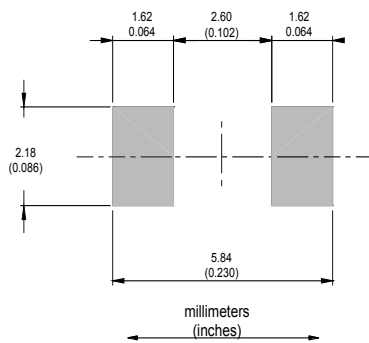

Figure 15. Marking layout

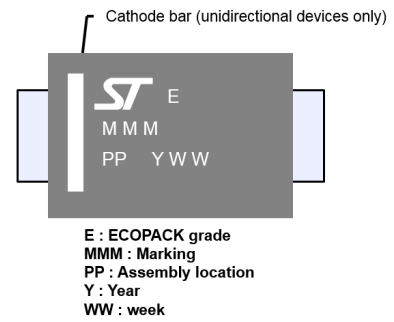
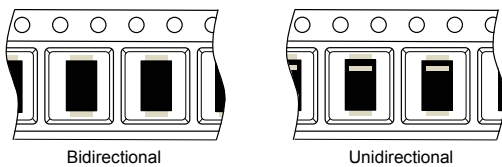

Figure 16. Package orientation in reel



Taped according to EIA-481
 Pocket dimensions are not on scale.
 Pocket shape may vary depending on package
 On bidirectional devices, marking and logo may not be always in the same direction.

Figure 17. Tape and reel orientation

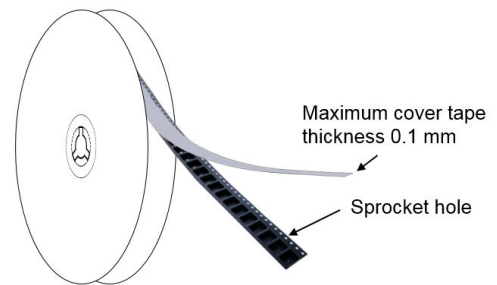

Figure 18. 13" reel dimensions (mm)

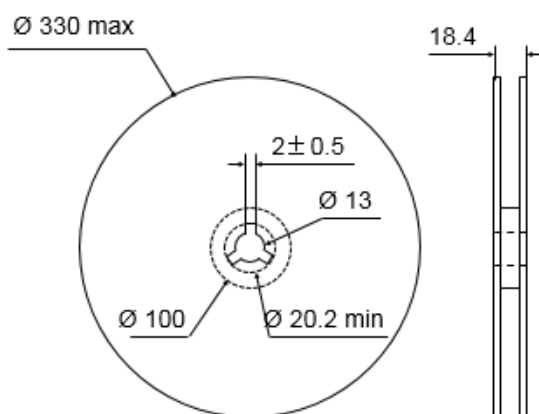

Figure 19. Inner box dimensions (mm)

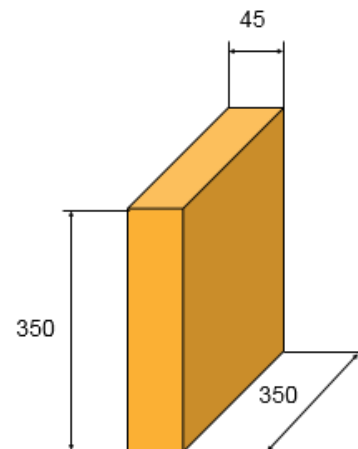
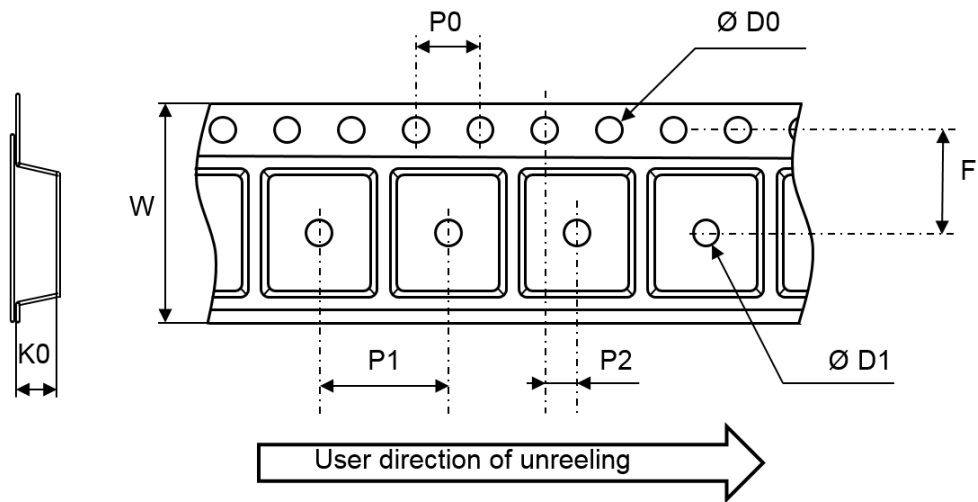

Figure 20. Tape and reel outline



Note: Pocket dimensions are not on scale
Pocket shape may vary depending on package

Table 4. Tape and reel mechanical data

Ref.	Dimensions		
	Millimeters		
	Min.	Typ.	Max.
ØD0	1.5	1.55	1.6
ØD1	1.5		
F	5.4	5.5	5.6
K0	2.64	2.74	2.84
P0	3.9	4.0	4.1
P1	7.9	8.0	8.1
P2	1.9	2.0	2.1
W	11.7	12.0	12.3

2.2 Reflow profile

Figure 21. ST ECOPACK recommended soldering reflow profile for PCB mounting

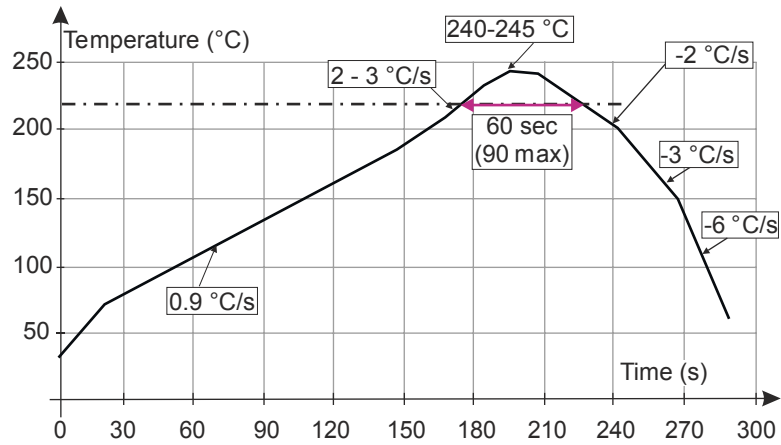

Note: Minimize air convection currents in the reflow oven to avoid component movement. Maximum soldering profile corresponds to the latest IPC/JEDEC J-STD-020.

3 Ordering information

Table 5. Ordering information

Order code	Marking	Package	Weight	Base qty.	Delivery mode
SMBJxxA / CA ⁽¹⁾	See Table 6. Marking.	SMB	0.11 g	2500	Tape and reel

1. Where xx corresponds to V_{RM} and A or CA indicates unidirectional or bidirectional version.

Table 6. Marking

Order code	Marking	Order code	Marking
SMBJ5.0A	BUZ	SMBJ5.0CA	BBZ
SMBJ6.0A	BUA	SMBJ6.0CA	BBA
SMBJ6.5A	BUB	SMBJ6.5CA	BBB
SMBJ8.5A	BUC	SMBJ8.5CA	BBC
SMBJ10A	BUD	SMBJ10CA	BBD
SMBJ12A	BUE	SMBJ12CA	BBE
SMBJ13A	BUF	SMBJ13CA	BBF
SMBJ15A	BUG	SMBJ15CA	BBG
SMBJ16A	CUG	SMBJ16CA	CBG
SMBJ18A	BUH	SMBJ18CA	BBH
SMBJ20A	BUI	SMBJ20CA	BBI
SMBJ22A	BVA	SMBJ22CA	CBH
SMBJ24A	BUJ	SMBJ24CA	BBJ
SMBJ26A	BUK	SMBJ26CA	BBK
SMBJ28A	BUL	SMBJ28CA	BBL
SMBJ30A	BUM	SMBJ30CA	BBM
SMBJ33A	BUN	SMBJ33CA	BBN
SMBJ36A	CUN	SMBJ36CA	CBN
SMBJ40A	CUJ	SMBJ40CA	CBJ
SMBJ48A	BUW	SMBJ48CA	BBW
SMBJ58A	BUO	SMBJ58CA	BBO
SMBJ64A	BUP	SMBJ64CA	BBP
SMBJ70A	CUM	SMBJ70CA	CBM
SMBJ85A	BUQ	SMBJ85CA	BBQ
SMBJ100A	CUQ	SMBJ100CA	CBQ
SMBJ130A	BUS	SMBJ130CA	BBS
SMBJ154A	BUT	SMBJ154CA	BBT
SMBJ170A	BUU	SMBJ170CA	BBU
SMBJ188A	BUV	SMBJ188CA	BBV

Revision history

Table 7. Document revision history

Date	Version	Changes
Oct-2001	4	Previous issue.
10-Feb-2005	5	Reformatted to current template. Added directional (uni and bi) indications to graphics. Added <i>ECOPACK</i> statement.
16-Nov-2006	6	Add part numbers SMBJ36A-TR and SMBJ36CA-TR in <i>Table 3</i> .
14-May-2009	7	Reformatted to current standards. Updated <i>ECOPACK</i> statement. Added part number SMBJ43CAVA.
17-Sep-2009	8	Document updated for low leakage current.
09-Jul-2010	9	Changed timescale in <i>Figure 9</i> .
20-Oct-2010	10	Updated <i>Figure 13</i> .
24-Jan-2018	11	Updated <i>Table 3</i> : "Electrical characteristics parameter values ($T_{amb} = 25\text{ °C}$, unless otherwise specified)".
26-Apr-2021	12	Updated <i>Table 6</i> . Minor text changes.
23-May-2024	13	Updated <i>Figure 11</i> .
04-Oct-2024	14	Updated Figure 3 , and Figure 9 . Minor text changes.

IMPORTANT NOTICE – READ CAREFULLY

STMicroelectronics NV and its subsidiaries (“ST”) reserve the right to make changes, corrections, enhancements, modifications, and improvements to ST products and/or to this document at any time without notice. Purchasers should obtain the latest relevant information on ST products before placing orders. ST products are sold pursuant to ST’s terms and conditions of sale in place at the time of order acknowledgment.

Purchasers are solely responsible for the choice, selection, and use of ST products and ST assumes no liability for application assistance or the design of purchasers’ products.

No license, express or implied, to any intellectual property right is granted by ST herein.

Resale of ST products with provisions different from the information set forth herein shall void any warranty granted by ST for such product.

ST and the ST logo are trademarks of ST. For additional information about ST trademarks, refer to www.st.com/trademarks. All other product or service names are the property of their respective owners.

Information in this document supersedes and replaces information previously supplied in any prior versions of this document.

© 2024 STMicroelectronics – All rights reserved