



# 36W Desktop C14 Adapter Series



## Features

- DOE Level VI Efficiency Compliant
- ErP/Ecodesign Directive 2009/125/EC – Regulation EU 2019/1782 Compliant
- EU CoC Tier 2 Compliant (except 5V and 12V models)
- Over Voltage, Short Circuit and Over Current Protection
- Non-Vented/Spill-Proof Case
- Class B EMI

## Applications

- Networking
- Peripherals
- Consumer Electronics

\*NRCan approval for PPL36U-050, PPL36U-090, PPL36U-120L6, PPL36U-150, PPL36U-180, PPL36U-240, PPL36U-480 models only

Phihong Taiwan - No.568, Fuxing 3rd Rd., Guishan Dist., Taoyuan City (33383), Taiwan, ROC

Phihong USA - 47800 Fremont Blvd. Fremont, CA 94538, USA

Phihong Europe - Wattstraat 50, 2171 TR Sassenheim, The Netherlands



# PPL36U Series Specifications<sup>1</sup>

Model		PPL36U-050 <sup>1</sup>	PPL36U-075	PPL36U-085	PPL36U-090 <sup>1</sup>
Output	DC Output Voltage	5.0V	7.5V	8.5V	9.0V
	Max Current	5.0A	4.0A	3.52A	3.34A
	Output Power	25.0W	30.0W	29.92W	30.06W
	Regulation	± 6%	± 5%	± 5%	± 5%
	Ripple & Noise P-P(max) <sup>2</sup>	80mV	75mV	85mV	90mV
Input	AC Input Voltage Range	90 to 264VAC			
	AC Input Frequency	47 to 63Hz			
	Input Current	1.0A max			
	Inrush Current	70A max., 230VAC (Cold Start at ambient 25°C)			
	No Load Power Consumption at 115VAC Input	≤ 0.1W	≤ 0.1W	≤ 0.1W	≤ 0.1W
	No Load Power Consumption at 230VAC Input	≤ 0.1W	≤ 0.075W	≤ 0.075W	≤ 0.075W
	115VAC Average Efficiency <sup>3</sup>	≥ 84.2%	≥ 86.9%	≥ 86.9%	≥ 87%
	230VAC Average Efficiency <sup>3</sup>	≥ 84.2%	≥ 87.6%	≥ 87.6%	≥ 87.6%
	230VAC 10% Load Efficiency <sup>3</sup>	≥ 76.9%	≥ 77.6%	≥ 77.6%	≥ 77.6%
	Leakage Current	<3.5mA			
Protection	Over-Voltage	180% max	180% max	180% max	180% max
	Short Circuit	Auto-recover after short-circuit fault is removed			
	Over-Current	200% max	200% max	200% max	200% max
Environmental	Operating Temperature	0°C to +40°C			
	Non-Operating Temperature	-20° to +80°C			
	Operating Humidity	20 to +80%			
Safety Approvals and EMC	Dielectric Withstand (HI-POT)	Primary to Secondary: 3000VAC for 1min, 10mA			
	Insulation Resistance	Primary to Secondary: 10M ohm for 500VDC			
	Standards	cULus 62368-1, IEC 62368-1			
	EMI Emissions	FCC Part 15 Class B, CAN ICES-003(B)/NMB-003(B), EN 55032/CISPR 32 Class B Conducted and Radiated			
	Harmonic Current Emissions	IEC 61000-3-2			
	Voltage Fluctuations & Flicker	IEC 61000-3-3			
	Immunity	EN 55035/CISPR 35: IEC 61000-4-2, IEC 61000-4-3, IEC 61000-4-4, IEC 61000-4-5, IEC 61000-4-6, IEC 61000-4-8, IEC 61000-4-11			
Mechanical	Dimensions (L x W x H)	100mm (3.94in) x 50mm (1.97in) x 33mm (1.30in)			
	Weight	170g			
	Cable Length	1000mm	1500mm		
	DC Cable Type	16 AWG	16 AWG	18 AWG	18 AWG
	DC Output Connector	2.1mm x 5.5mm x 10.0mm			
	DC Plug Pin Assignment	Inner (V+) / Outer GND (V-)			
	Input Connector	IEC 60320 C14			

Model		PPL36U-120L6'	PPL36U-135	PPL36U-150'	PPL36U-160
Output	DC Output Voltage	12.0V	13.5V	15.0V	16.0V
	Max Current	3.0A	2.66A	2.4A	2.25A
	Output Power	36.0W	35.91W	36.0W	36.0W
	Regulation	± 5%	± 5%	± 5%	± 5%
	Ripple & Noise P-P(max) <sup>2</sup>	120mV	135mV	150mV	160mV
Input	AC Input Voltage Range	90 to 264VAC			
	AC Input Frequency	47 to 63Hz			
	Input Current	1.0A max			
	Inrush Current	70A max., 230VAC (Cold Start at ambient 25°C)			
	No Load Power Consumption at 115VAC Input	≤ 0.1W	≤ 0.1W	≤ 0.1W	≤ 0.1W
	No Load Power Consumption at 230VAC Input	≤ 0.1W	≤ 0.075W	≤ 0.075W	≤ 0.075W
	115VAC Average Efficiency <sup>3</sup>	≥ 87.4%	≥ 87.4%	≥ 87.4%	≥ 87.4%
	230VAC Average Efficiency <sup>3</sup>	≥ 87.4%	≥ 88.3%	≥ 88.3%	≥ 88.3%
	230VAC 10% Load Efficiency <sup>3</sup>	≥ 78.3%	≥ 78.3%	≥ 78.3%	≥ 78.3%
Leakage Current	<3.5mA				
Protection	Over-Voltage	180% max	180% max	180% max	180% max
	Short Circuit	Auto-recover after short-circuit fault is removed			
	Over-Current	200% max	200% max	200% max	200% max
Environmental	Operating Temperature	0°C to +40°C			
	Non-Operating Temperature	-20° to +80°C			
	Operating Humidity	20 to +80%			
Safety Approvals and EMC	Dielectric Withstand (HI-POT)	Primary to Secondary: 3000VAC for 1min, 10mA			
	Insulation Resistance	Primary to Secondary: 10M ohm for 500VDC			
	Standards	cULus 62368-1, IEC 62368-1			
	EMI Emissions	FCC Part 15 Class B, CAN ICES-003(B)/NMB-003(B), EN 55032/CISPR 32 Class B Conducted and Radiated			
	Harmonic Current Emissions	IEC 61000-3-2			
	Voltage Fluctuations & Flicker	IEC 61000-3-3			
	Immunity	EN 55035/CISPR 35: IEC 61000-4-2, IEC 61000-4-3, IEC 61000-4-4, IEC 61000-4-5, IEC 61000-4-6, IEC 61000-4-8, IEC 61000-4-11			
Mechanical	Dimensions (L x W x H)	100mm (3.94in) x 50mm (1.97in) x 33mm (1.3in)			
	Weight	170g			
	Cable Length	1500mm			
	DC Cable Type	18 AWG	18 AWG	18 AWG	18 AWG
	DC Output Connector	2.1mm x 5.5mm x 10.0mm			
	DC Plug Pin Assignment	Inner (V+) / Outer GND (V-)			
	Input Connector	IEC 60320 C14			

Model		PPL36U-180 <sup>1</sup>	PPL36U-240 <sup>1</sup>	PPL36U-480 <sup>1</sup>
Output	DC Output Voltage	18.0V	24.0V	48.0V
	Max Current	2.0A	1.5A	0.75A
	Output Power	36.0W	36.0W	36.0W
	Regulation	± 5%	± 5%	± 5%
	Ripple & Noise P-P(max) <sup>2</sup>	180mV	240mV	480mV
Input	AC Input Voltage Range	90 to 264VAC		
	AC Input Frequency	47 to 63Hz		
	Input Current	1.0A max		
	Inrush Current	70A max., 230VAC (Cold Start at ambient 25°C)		
	No Load Power Consumption at 115VAC Input	≤ 0.1W	≤ 0.1W	≤ 0.1W
	No Load Power Consumption at 230VAC Input	≤ 0.075W	≤ 0.075W	≤ 0.075W
	115VAC Average Efficiency <sup>3</sup>	≥ 87.4%	≥ 87.4%	≥ 87.4%
	230VAC Average Efficiency <sup>3</sup>	≥ 88.3%	≥ 88.3%	≥ 88.3%
	230VAC 10% Load Efficiency <sup>3</sup>	≥ 78.3%	≥ 78.3%	≥ 78.3%
	Leakage Current	<3.5mA		
Protection	Over-Voltage	180% max	180% max	180% max
	Short Circuit	Auto-recover after short-circuit fault is removed		
	Over-Current	200% max	200% max	200% max
Environmental	Operating Temperature	0°C to +40°C		
	Non-Operating Temperature	-20° to +80°C		
	Operating Humidity	20 to +80%		
Safety Approvals and EMC	Dielectric Withstand (HI-POT)	Primary to Secondary: 3000VAC for 1min, 10mA		
	Insulation Resistance	Primary to Secondary: 10M ohm for 500VDC		
	Standards	cULus 62368-1, IEC 62368-1		
	EMI Emissions	FCC Part 15 Class B, CAN ICES-003(B)/NMB-003(B), EN 55032/CISPR 32 Class B Conducted and Radiated		
	Harmonic Current Emissions	IEC 61000-3-2		
	Voltage Fluctuations & Flicker	IEC 61000-3-3		
	Immunity	EN 55035/CISPR 35: IEC 61000-4-2, IEC 61000-4-3, IEC 61000-4-4, IEC 61000-4-5, IEC 61000-4-6, IEC 61000-4-8, IEC 61000-4-11		
Mechanical	Dimensions (L x W x H)	100mm (3.94in) x 50mm (1.97in) x 33mm (1.3in)		
	Weight	170g		
	Cable Length	1500mm		
	DC Cable Type	18 AWG	20 AWG	22 AWG
	DC Output Connector	2.1mm x 5.5mm x 10.0mm		
	DC Plug Pin Assignment	Inner (V+) / Outer GND (V-)		
	Input Connector	IEC 60320 C14		
Notes	<ol style="list-style-type: none"> <li>The specifications defined are at ambient temperature of 25C, unless otherwise specified.</li> <li>20MHz bandwidth frequency oscilloscope, add a 0.1µF multilayer Cap. and Low ESR Electrolytic Cap. (10µF) at output connector terminals (nominal line voltage, full load).</li> <li>Efficiency is measured after 30 minutes burn-in.</li> </ol>			

\*NRCan approval for PPL36U-050, PPL36U-090, PPL36U-120L6. PPL36U-150, PPL36U-180, PPL36U-240, PPL36U-480 models only



# PPL36U Outline Drawing

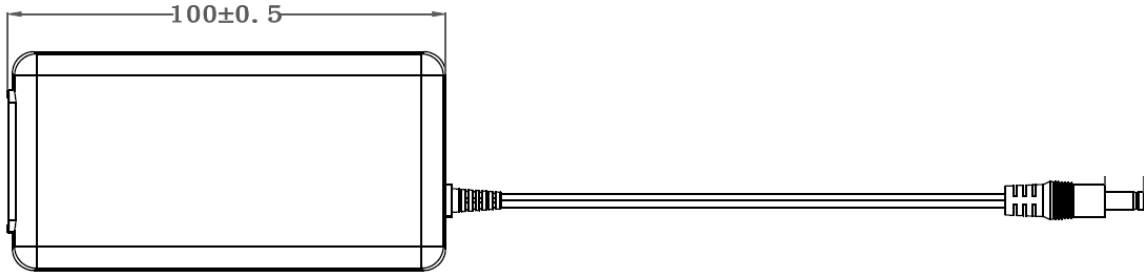

TOP VIEW

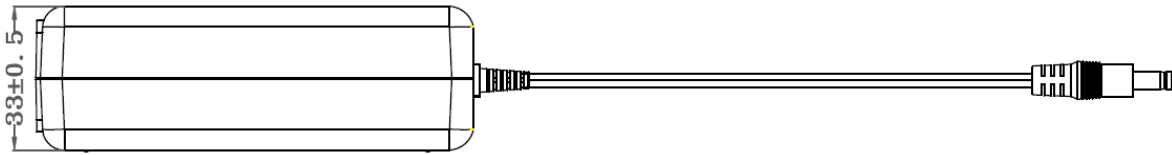

SIDE VIEW

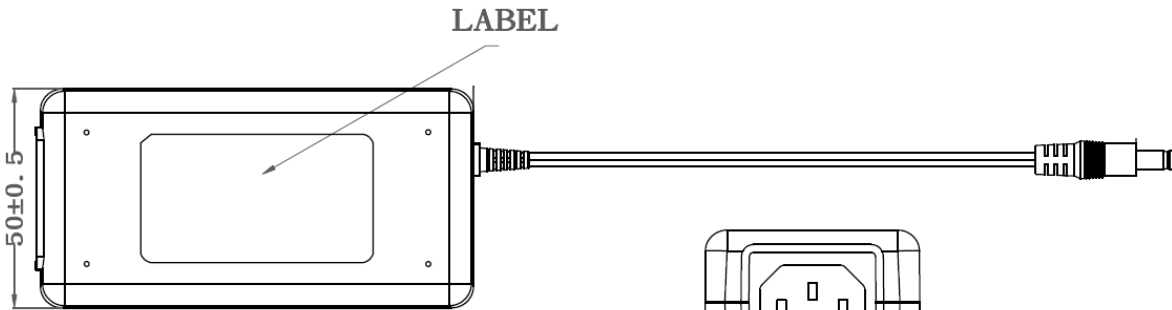

BOTTOM VIEW

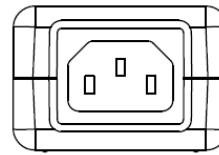

FRONT-VIEW





**Supplier's Declaration of Conformity**  
**47 CFR § 2.1077 Compliance Information**

Phihong USA Corporation  
47800 Fremont Boulevard  
Fremont, CA 94538  
Telephone: (510) 445-0100  
[www.phihong.com](http://www.phihong.com)

*This device complies with/The devices in this product series comply with part 15 of the FCC Rules. Operation is subject to the following two conditions: (1) This device may not cause harmful interference, and (2) this device must accept any interference received, including interference that may cause undesired operation.*



# PPL36U Line Cords Sold Separately

Model		AC30UNA-R	AC30UEU-R	AC30UUK-R
Specifications	Plug Type	North America NEMA 5-15P	Continental Europe CEE 7VIII	United Kingdom BS 1363
	Connector	IEC320 C13	IEC320 C13	IEC320 C13
	Wire Size	18 AWG	0.75mm	1.0mm
	Temperature	60°C	70°C	70 °C
	Amperage Rating	10A	6A	10A
	Voltage Rating	125V	250V	250V
	Cable Length	1830mm	1830mm	2500mm
Safety Approvals		CSA; UL	CEBEC; DEMKO; DVE; FIMKO; GOST; IMQ; KEMA; NEMKO; NF; OVE; SEMKO	BSI; Safety Mark
Photos				



# PPL36U Line Cords Outline Drawings

**AC30UNA-R**

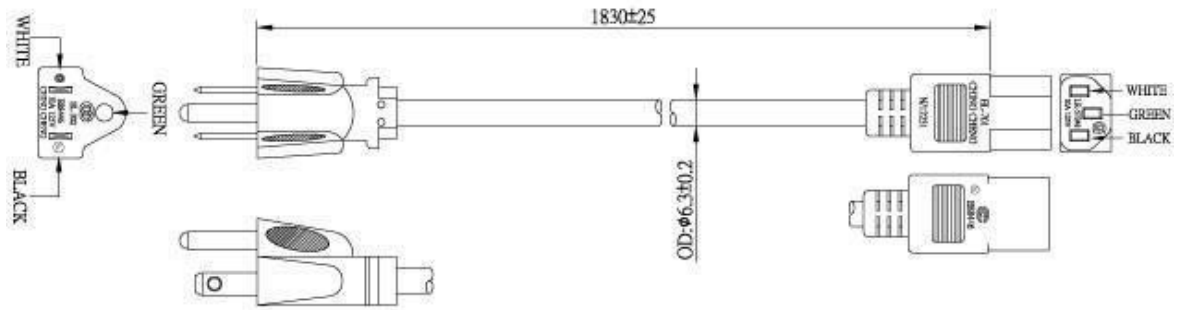

**AC30UEU-R**

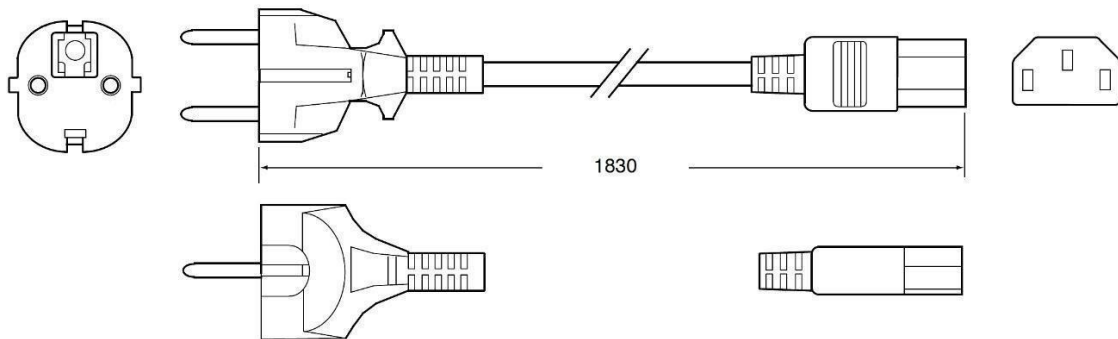

**AC30UUK-R**

