

HDSM-201x, HDSM-203x

0.2-Inch Single-Digit Surface-Mount Display

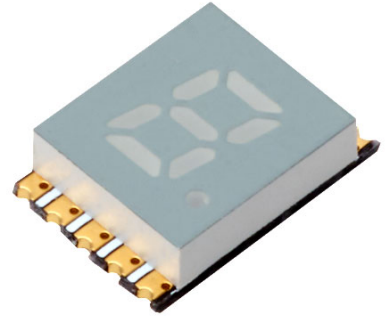

Description

The Broadcom[®] HDSM-201x/HDSM-203x 0.2-inch single-digit surface-mount display uses AlInGaP chip technology. The gray top surface and white segments provide optimum contrast. This device is available in a common cathode and common anode configuration.

To facilitate easy pick-and-place assembly, the LED displays are packed in tape and reel form.

Features

- Low current operation
- Excellent character appearance
- Available in yellow, green, and red color
- JEDEC MSL 3
- RoHS compliant

Applications

- Industrial
- Consumer
- Home appliance displays
- Medical
- Office automation
- Avionic instrumentation

CAUTION! This LED is ESD sensitive. Observe appropriate precautions during handling and processing. Refer to Application Note 1142 for additional details.

Figure 1: Package Drawing

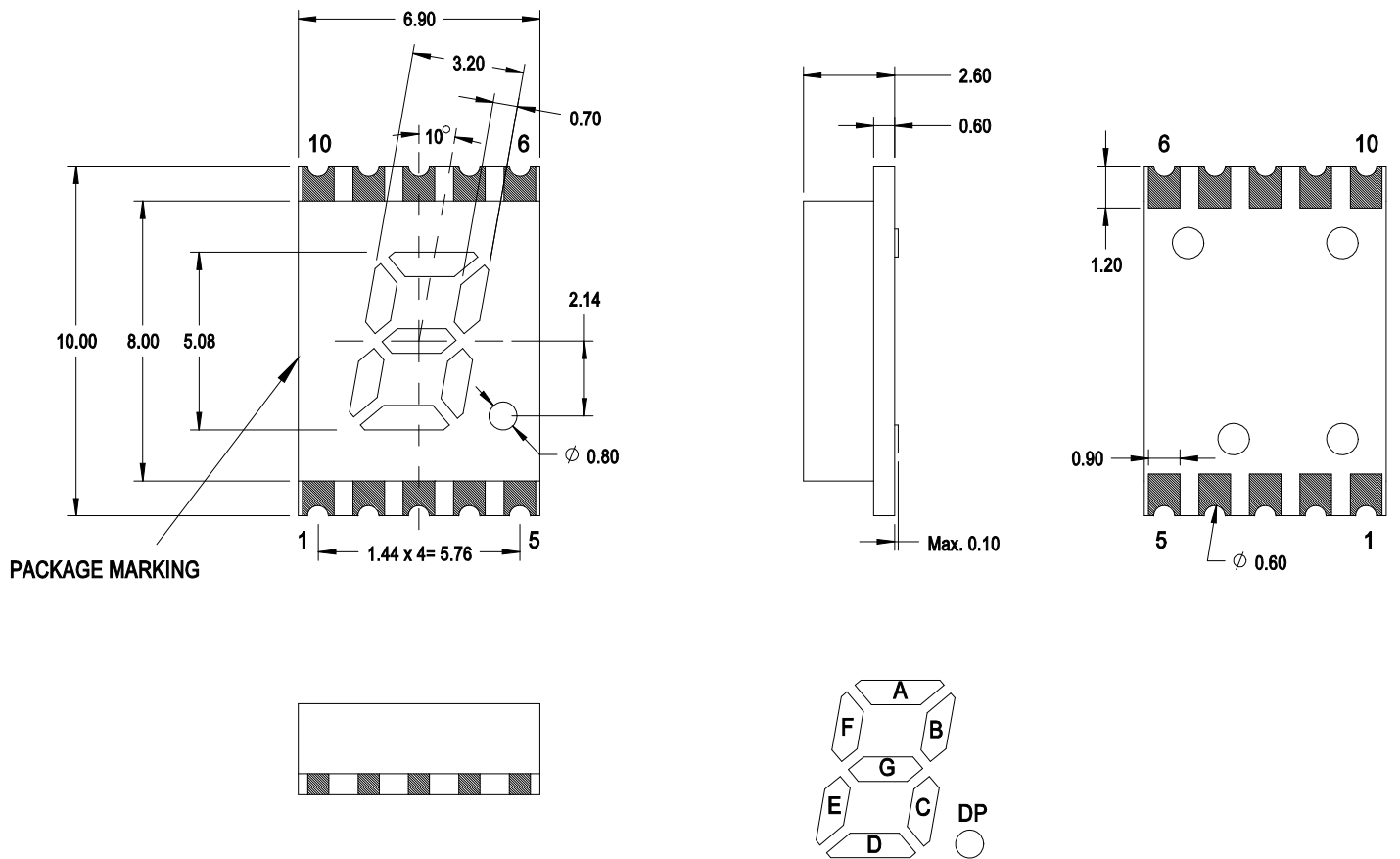

The package marking includes:

- Part Number: HDSM-20xx
- Date Code: YYWW
- Intensity Bin (refer to the Intensity Bin table)

NOTE:

1. All dimensions are in millimeters (mm).
2. The tolerance is ± 0.25 mm unless otherwise specified.

Figure 2: Internal Circuit Diagram

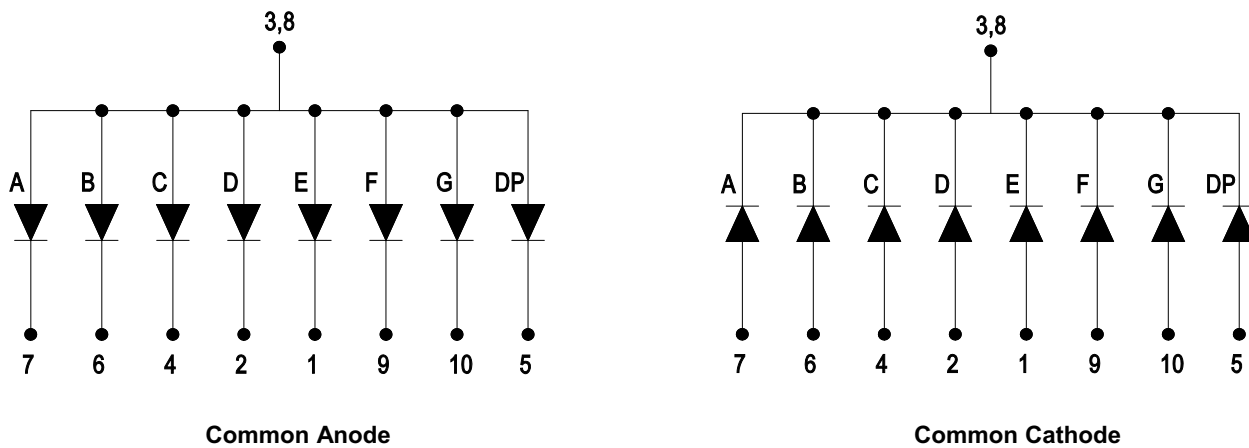

Pin Connection

Common Anode

Pin	Configurations
1	Cathode E
2	Cathode D
3	Common Anode
4	Cathode C
5	Cathode DP
6	Cathode B
7	Cathode A
8	Common Anode
9	Cathode F
10	Cathode G

Common Cathode

Pin	Configurations
1	Anode E
2	Anode D
3	Common Cathode
4	Anode C
5	Anode DP
6	Anode B
7	Anode A
8	Common Cathode
9	Anode F
10	Anode G

Device Selection Guide

Part Number	Color	Description
HDSM-201C	Red	Common Anode, Gray Surface, Right-Hand Decimal
HDSM-203C	Red	Common Cathode, Gray Surface, Right-Hand Decimal
HDSM-201H	Green	Common Anode, Gray Surface, Right-Hand Decimal
HDSM-203H	Green	Common Cathode, Gray Surface, Right-Hand Decimal
HDSM-201F	Yellow	Common Anode, Gray Surface, Right-Hand Decimal
HDSM-203F	Yellow	Common Cathode, Gray Surface, Right-Hand Decimal

Absolute Maximum Ratings

Parameters	HDSM-20xx	Unit
DC Forward Current ^a	25	mA
Peak Forward Current ^b	100	mA
Power Dissipation	65	mW
Reverse Voltage	Not designed for reverse bias operation	
Operating Temperature Range	-40 to +105	°C
Storage Temperature Range	-40 to +105	°C

a. Derate linearly as shown in Figure 6.

b. Duty factor = 10%, frequency = 1 kHz, $T_A = 25^\circ\text{C}$.

Optical and Electrical Characteristics ($T_J = 25^\circ\text{C}$)

Parameters	Min.	Typ.	Max.	Unit	Test Conditions
Luminous Intensity, I_V (Average per Segment) ^{a,b}					
Red	8.6	15	—	mcd	$I_F = 10\text{ mA}$
Green	3.4	5	—		
Yellow	5.4	10	—		
Luminous Intensity Matching Ratio (Segment to Segment)	—	—	2.1	—	$I_F = 10\text{ mA}$
Dominant Wavelength, λ_d ^c					
Red	—	635	—	nm	$I_F = 20\text{ mA}$
Green	—	572	—		
Yellow	—	590	—		
Peak Wavelength, λ_p					
Red	—	649	—	nm	$I_F = 20\text{ mA}$
Green	—	573	—		
Yellow	—	593	—		
Forward Wavelength, V_F ^d					
Red	—	2.2	2.6	V	$I_F = 20\text{ mA}$
Green	—	2.1	2.6		
Yellow	—	2.1	2.6		
Reverse Current, I_R ^e	—	—	100	μA	$V_R = 5\text{ V}$

a. The luminous intensity, I_V , is measured at the mechanical axis of the package and is tested with a single-current pulse condition. The actual peak of the spatial radiation pattern may not be aligned with the axis.

b. The tolerance is $\pm 15\%$.

c. The dominant wavelength, λ_d , is derived from the CIE Chromaticity Diagram and represents the perceived color of the device.

d. The forward voltage tolerance is $\pm 0.1\text{ V}$.

e. Indicates the product final test condition. Long-term reverse bias is not recommended.

Bin Information

Intensity Bin Limits (CAT)

Red

Bin ID	Luminous Intensity, I_V (mcd)	
	Min.	Max.
N	8.601	13.700
P	13.701	21.800
Q	21.801	34.700

Green

Bin ID	Luminous Intensity, I_V (mcd)	
	Min.	Max.
L	3.401	5.400
M	5.401	8.600
N	8.601	13.700

Yellow

Bin ID	Luminous Intensity, I_V (mcd)	
	Min.	Max.
M	5.401	8.600
N	8.601	13.700
P	13.701	21.800

Tolerance = $\pm 15\%$.

Example of bin information on reel and packaging label:

CAT: M – Intensity bin M

Figure 3: Spectral Power Distribution

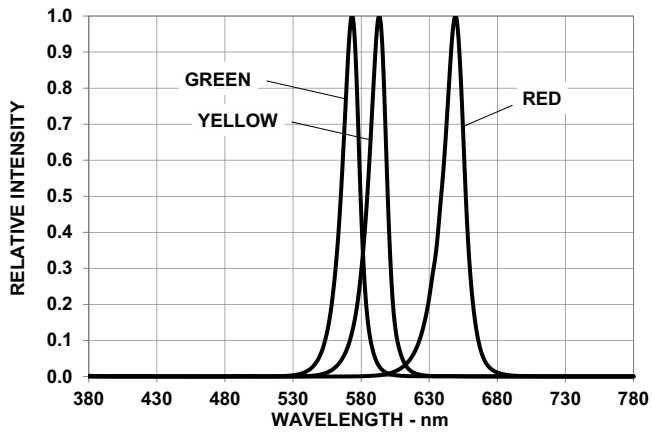

Figure 4: Forward Current vs. Forward Voltage

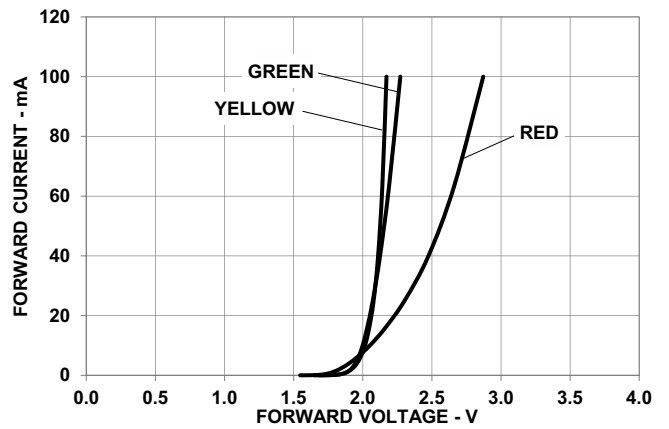

Figure 5: Relative Luminous Intensity vs. Mono Pulse Current

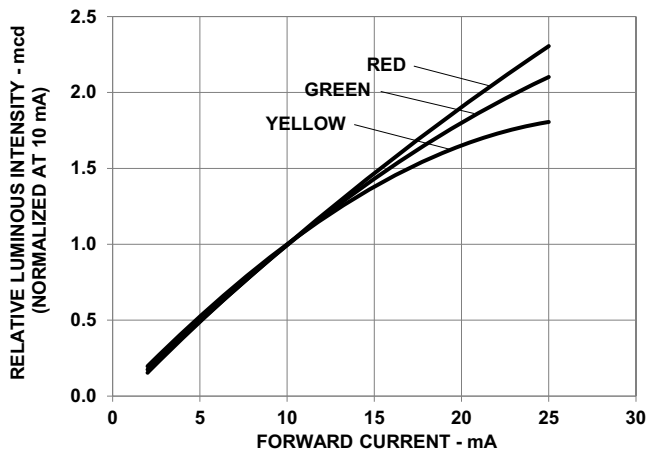

Figure 6: Maximum Forward Current vs. Ambient Temperature

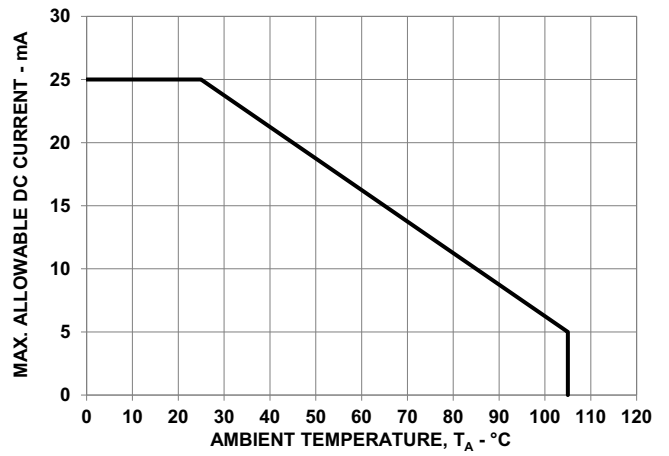
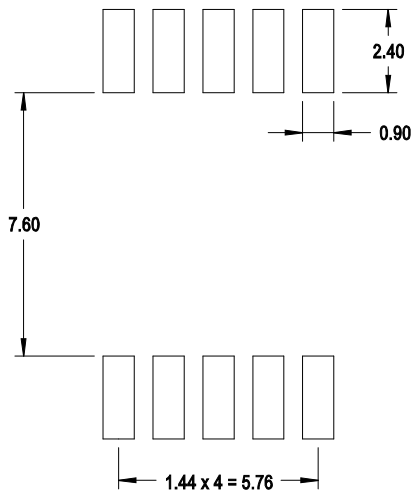
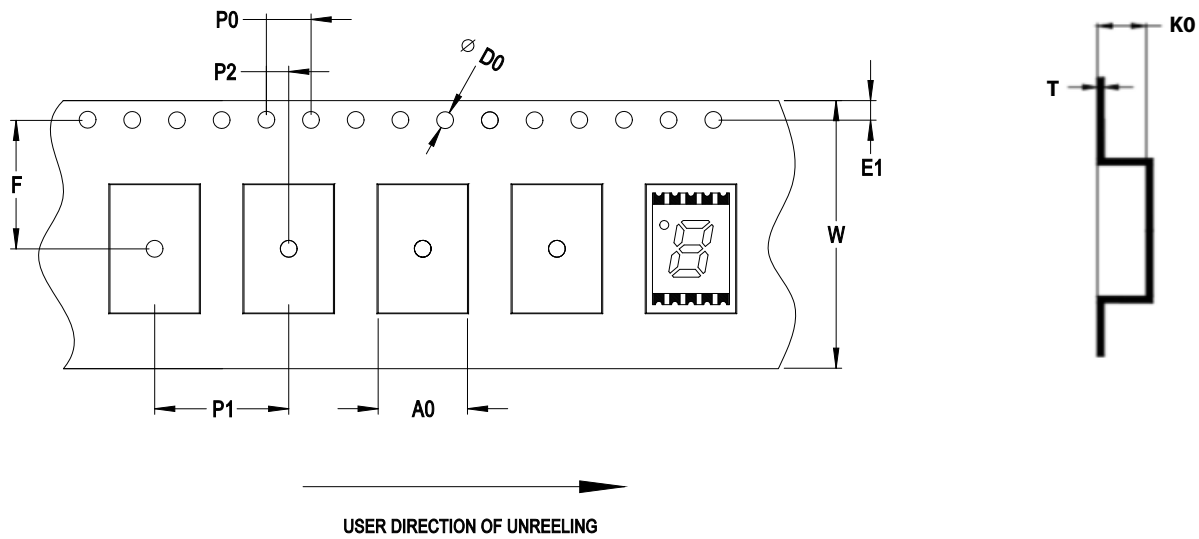

Figure 7: Recommended Soldering Land Pattern



NOTE: All dimensions are in millimeters (mm).

Figure 8: Carrier Tape Dimensions



F	P0	P1	P2	D0	E1	W
11.5 ±0.1	4.0 ±0.1	12.0 ±0.1	2.0 ±0.1	1.50 +0.1/-0.0	1.75 ±0.1	24.0 ±0.1

T	K0	A0
0.35 ±0.1	4.0 ±0.1	8.0 ±0.1

NOTE:

1. All dimensions are in millimeters (mm).
2. Quantity per reel: 1000 pieces.

Figure 9: Reel Dimensions

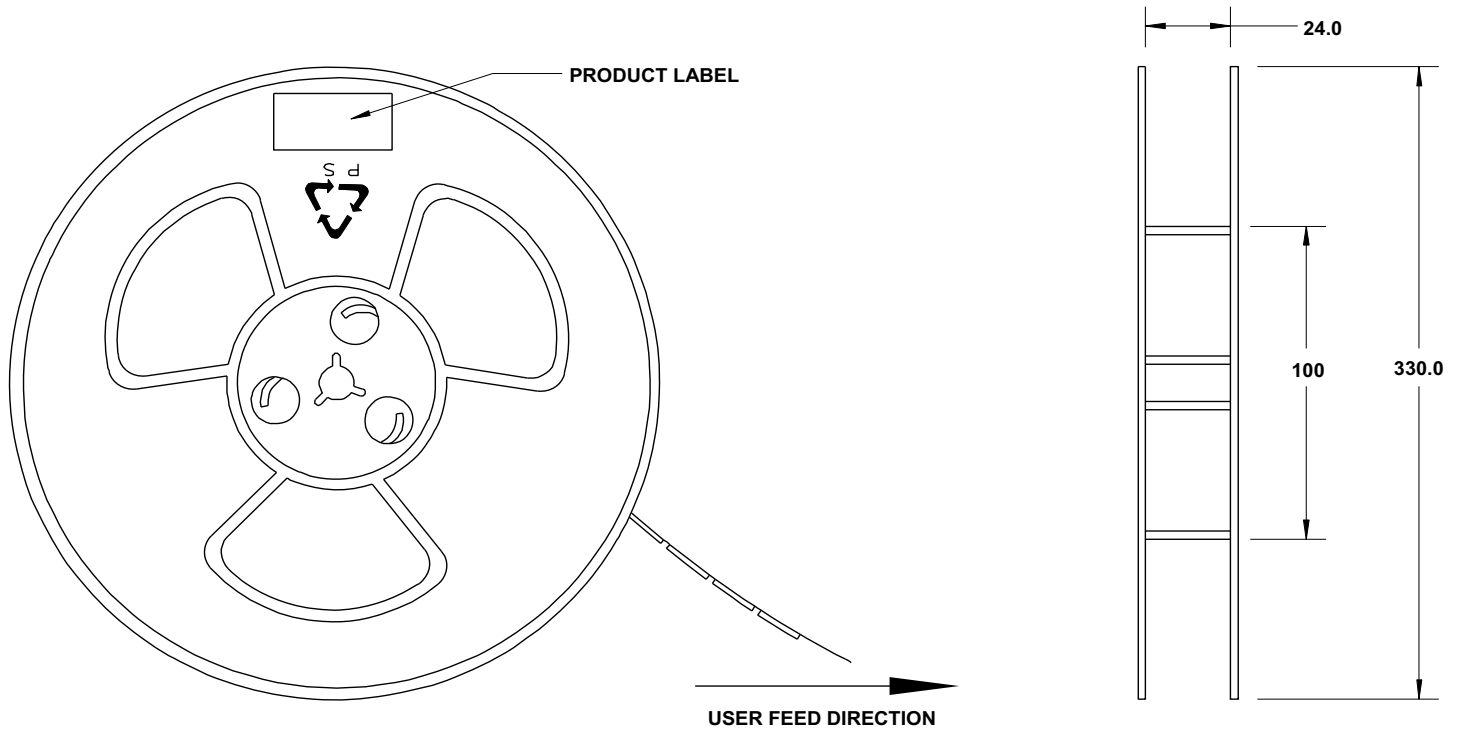

NOTE: All dimensions are in millimeters (mm).

Precautionary Notes

Soldering and Handling Precautions

- Do not perform reflow soldering more than twice. Allow the product to cool to normal room temperature before second reflow. Observe necessary precautions of handling moisture-sensitive device as stated in the following section.
- Do not apply any pressure or force on the LED display during reflow and after reflow when it is still hot.
- Use reflow soldering to solder the LED display. Use hand soldering only for rework if unavoidable, but it must be strictly controlled to the following conditions:
 - Soldering iron tip temperature = 315°C maximum
 - Soldering duration = 2 seconds maximum
 - Number of cycles = 1 only
 - Power of soldering iron = 50W maximum
- Do not touch the LED package body with the soldering iron except for the soldering terminals because it can cause damage to the LED.
- Confirm beforehand whether the functionality and performance of the LED display are affected by soldering with hand soldering.
- Use solder paste with no-clean flux for soldering.

Figure 10: Recommended Lead-Free Reflow Soldering Profile

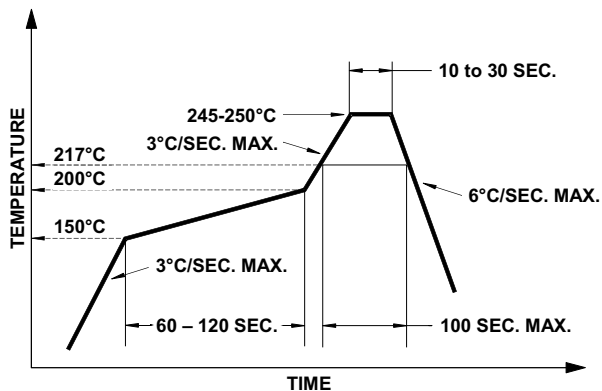

NOTE: The peak temperature refers to the peak package body temperature.

- To remove foreign particles on the surface of package, use a wet cotton bud with isopropyl alcohol (IPA). During cleaning, rub the surface gently without putting too much pressure. Do not wash or soak the LED display in any solution.

- Cleaning agents from the ketone family (acetone, methyl ethylketone, and so on) and from the chlorinated hydrocarbon family (methylene chloride, trichloroethylene, carbon tetrachloride, and so on) are not recommended for cleaning the LED displays. All of these various solvents attack or dissolve the encapsulating epoxies used to form the package of plastic LED parts.

Handling Moisture-Sensitive Devices

The product has a Moisture Sensitive Level 3 rating per JEDEC J-STD-020. Refer to Broadcom Application Note 5305, *Handling Moisture-Sensitive Surface-Mount LEDs*, for additional details and a review of proper handling procedures.

Before use:

- An unopened moisture barrier bag (MBB) can be stored at <40°C/90% RH for 12 months. If the actual shelf life has exceeded 12 months and the humidity indicator card (HIC) indicates that baking is not required, then it is safe to reflow the LED displays per the original MSL rating.
- Do not open the MBB prior to assembly (for example, for IQC). If unavoidable, the MBB must be properly resealed with fresh desiccant and HIC. The exposed duration must be taken in as floor life.

Control after opening the MBB:

- Read the HIC immediately upon opening of the MBB.
- Keep the LEDs at <30°/60%RH at all times, and complete all high-temperature-related processes, including soldering, curing, or rework within 168 hours.

Control for unfinished reels:

- Store unused LED displays in a sealed MBB with desiccant or a desiccator at <5% RH.

Control of assembled boards:

- If the PCB soldered with the LED displays is to be subjected to other high-temperature processes, store the PCB in a sealed MBB with desiccant or a desiccator at <5% RH to ensure that all LED displays have not exceeded their floor life of 168 hours.

Baking is required if any of these conditions exist:

- The HIC indicator indicates a change in color for 10% and 5%, as stated on the HIC.
- The LED displays are exposed to conditions of >30°C/60% RH at any time.
- The LED display's floor life exceeded 168 hours.

The recommended baking condition is: 60 ±5°C for 20 hours.

Baking can be done only once.

Application Precautions

- The drive current of the LED must not exceed the maximum allowable limit across temperature as stated in this data sheet. Constant current driving is recommended to ensure consistent performance.
- Circuit design must cater to the whole range of forward voltage (V_F) of the LEDs to ensure that the intended drive current can always be achieved.
- The LED exhibits slightly different characteristics at different drive currents, which can result in a larger variation of performance (such as intensity, wavelength, and forward voltage). Set the application current as close as possible to the test current to minimize these variations.
- The LED is not intended for reverse bias. Use other appropriate components for such purposes. When driving the LED in matrix form, ensure that the reverse bias voltage does not exceed the allowable limit of the LED.
- Do not use the LED in the vicinity of material with sulfur content or in environments of high gaseous sulfur compounds and corrosive elements. Examples of material that might contain sulfur are rubber gaskets, room-temperature vulcanizing (RTV) silicone rubber, rubber gloves, and so on. Prolonged exposure to such environments might affect the optical characteristics and product life.
Because the actual application might not be exactly similar to the test conditions, do verify that the LED will not be damaged by prolonged exposure in the intended environment.
- Avoid rapid changes in ambient temperatures, especially in high-humidity environments, because they cause condensation on the LED.
- If the LED is intended to be used in a harsh or outdoor environment, protect the LED against damages caused by rain water, water, dust, oil, corrosive gases, external mechanical stresses, and so on.

Eye Safety Precautions

LED displays can pose optical hazards when in operation. Do not look directly at operating LED displays because it might be harmful to the eyes. For safety reasons, use appropriate shielding or personal protective equipment.

Disclaimer

Broadcom's products and software are not specifically designed, manufactured, or authorized for sale as parts, components, or assemblies for the planning, construction, maintenance, or direct operation of a nuclear facility or for use in medical devices or applications. The customer is solely responsible, and waives all rights to make claims against Broadcom or its suppliers, for all loss, damage, expense, or liability in connection with such use.

Copyright © 2023–2025 Broadcom. All Rights Reserved. The term “Broadcom” refers to Broadcom Inc. and/or its subsidiaries. For more information, go to www.broadcom.com. All trademarks, trade names, service marks, and logos referenced herein belong to their respective companies.

Broadcom reserves the right to make changes without further notice to any products or data herein to improve reliability, function, or design. Information furnished by Broadcom is believed to be accurate and reliable. However, Broadcom does not assume any liability arising out of the application or use of this information, nor the application or use of any product or circuit described herein, neither does it convey any license under its patent rights nor the rights of others.

