

CRYSTAL OSCILLATOR TEST & BURN IN SOCKET

AXS-7550-06-03

Precision test socket for 7.5x5.0mm,
6 pad crystal oscillator packages.



RoHS
Compliant



FEATURES:

- Accurate and reliable testing of frequency control devices
- Contact force ideal for avoiding measurement error
- Highest quality socket available
- Clam shell design for easy open and close
- Reliable gold plated POGO pins
- Suitable for high temperature burn-in test
- Operating Temperature: -30 ~ +150°C

APPLICATIONS:

- Design stage component engineering evaluation
- Supplier comparison tests
- High temperature burn-in board testing
- Prototyping

SIDE VIEW (OPEN):

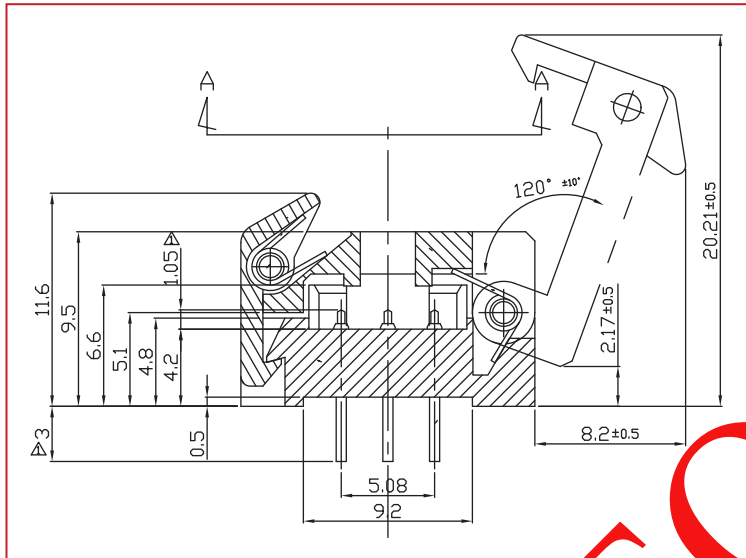

POCKET TOP VIEW:

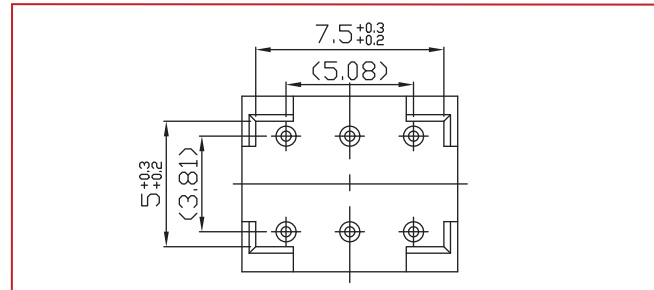

PIN DIMENSIONS:

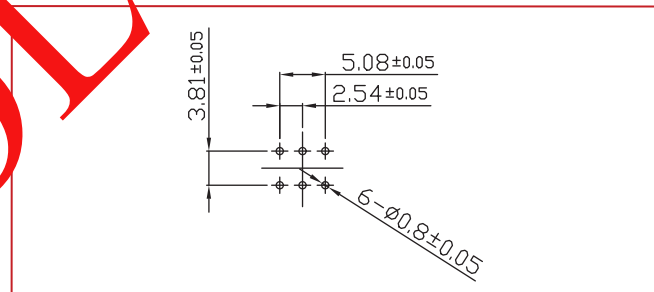

END VIEW:

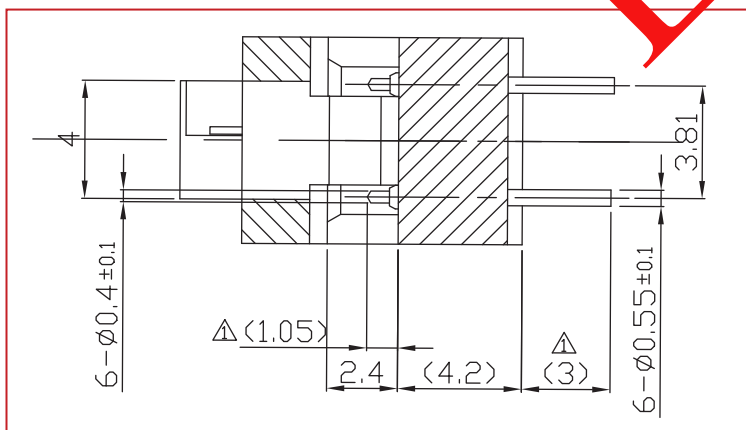

SUITABLE CRYSTAL OSCILLATOR PACKAGE DIMENSIONS:

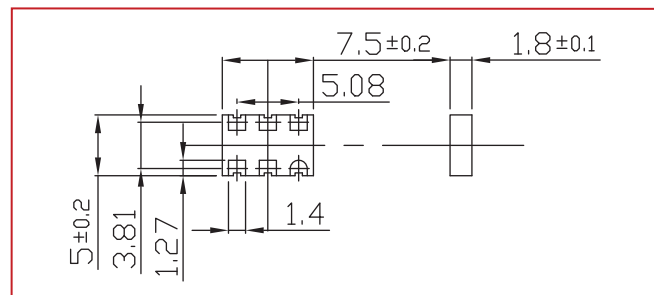

Dimensions: mm

ORDERING INFORMATION:

When ordering, please refer to part number

AXS-7550-06-03

RECOMMENDED FOR USE WITH DEVICE PACKAGE DIMENSIONS:

7.5 x 5.0 x 1.8mm

COMPATIBLE ABRACON SURFACE MOUNT OSCILLATOR:

ABFM, ASPE

(for a pdf download go to www.abracon.com/oscillators.htm)

* ABRACON test and burn in sockets are compatible with all industry standard frequency control packages.

ABRACON IS
ISO 9001 / QS 9000
CERTIFIED



Visit www.abracon.com for Terms & Conditions of Sale **Revised: 07.13.09**

30332 Esperanza, Rancho Santa Margarita, California 92688

tel 949-546-8000 | fax 949-546-8001 | www.abracon.com