

## 30 A - 600 V H-series Snubberless Triac

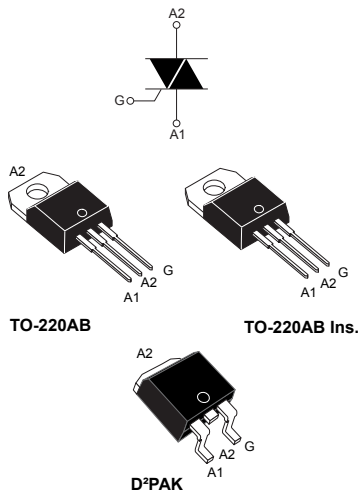

### Features

- High current Triac
- High immunity level
- Low thermal resistance with clip bonding
- Very high 3 quadrant commutations at 150 °C capabilities
- Packages are RoHS (2002/95/EC) compliant
- UL certified (ref. file E81734)

### Application

Thanks to its high electrical noise immunity level and its strong current robustness, the T3035H, T3050H series is designed for the control of AC actuators in appliances and industrial systems.

### Description

Specifically designed to operate at 150 °C, the 30 A triacs T3050H provide very high dynamic and enhanced performance in terms of power loss and thermal dissipation. This allows the heatsink size optimization, leading to space and cost effectiveness when compared to electro-mechanical solutions.

Based on ST Snubberless technology, they offer a specified minimal commutation and high noise immunity levels valid up to the  $T_j$  max.

These devices safely optimize the control of universal motors and inductive loads found in power tools and major appliances.

By using an internal ceramic pad, they provide voltage insulation (rated at 2500  $V_{RMS}$ ).

#### Product status link

[T3035H, T3050H](#)

#### Product summary

|                   |             |
|-------------------|-------------|
| $I_{T(RMS)}$      | 30 A        |
| $V_{DRM}/V_{RRM}$ | 600 V       |
| $I_{GT}$          | 35 or 50 mA |

# 1 Characteristics

**Table 1. Absolute maximum ratings (limiting values)**

| Symbol            | Parameter   |                                 |                       | Value                   | Unit             |
|-------------------|---|---------------------------------|-----------------------|-------------------------|------------------|
| $I_{T(RMS)}$      | RMS on-state current (full sine wave)   | D <sup>2</sup> PAK,<br>TO-220AB | $T_c = 121\text{ °C}$ | 30                      | A                |
|                   |   | TO-220AB Ins.                   | $T_c = 92\text{ °C}$  |                         |                  |
| $I_{TSM}$         | Non repetitive surge peak on-state current<br>(full cycle, $T_j$ initial = 25 °C)               | f = 50 Hz                       | t = 20 ms             | 270                     | A                |
|                   |   | f = 60 Hz                       | t = 16.7 ms           | 284                     |                  |
| $I^2t$            | $I^2t$ value for fusing   |                                 | $t_p = 10\text{ ms}$  | 487                     | A <sup>2</sup> s |
| dI/dt             | Critical rate of rise of on-state current,<br>$I_G = 2 \times I_{GT}$ , tr ≤ 100 ns, f = 100 Hz | f = 120 Hz                      | $T_j = 150\text{ °C}$ | 50                      | A/μs             |
| $V_{DSM}/V_{RSM}$ | Non Repetitive peak off-state voltage   | $t_p = 10\text{ ms}$            | $T_j = 25\text{ °C}$  | $V_{DRM}/V_{RRM} + 100$ | V                |
| $I_{GM}$          | Peak gate current   | $t_p = 20\text{ μs}$            | $T_j = 150\text{ °C}$ | 4                       | A                |
| $P_{G(AV)}$       | Average gate power dissipation  |                                 | $T_j = 150\text{ °C}$ | 1                       | W                |
| $T_{stg}$         | Storage temperature range   |                                 |                       | -40 to +150             | °C               |
| $T_j$             | Operating junction temperature range  |                                 |                       | -40 to +150             | °C               |

**Table 2. Electrical characteristics ( $T_j = 25\text{ °C}$ , unless otherwise specified)**

| Symbol                              | Test conditions                           | Quadrants             |      | Value  |        | Unit |
|-------------------------------------|---|-----------------------|------|--------|--------|------|
|                                     |   |                       |      | T3035H | T3050H |      |
| $I_{GT}^{(1)}$                      | $V_D = 12\text{ V}$ , $R_L = 33\text{ Ω}$ | I - II - III          | Max. | 35     | 50     | mA   |
| $V_{GT}$                            |   |                       | Max. | 1.0    |        | V    |
| $V_{GD}$                            | $V_D = V_{DRM}$ , $R_L = 3.3\text{ kΩ}$   | I - II - III          | Max. | 0.15   |        | V    |
| $I_L$                               | $I_G = 1.2 \times I_{GT}$                 | I - III               | Max. | 75     | 90     | mA   |
|                                     |   | II                    | Max. | 90     | 110    |      |
| $I_H^{(2)}$                         | $I_T = 500\text{ mA}$ , gate open         |                       | Max. | 60     | 75     | mA   |
| dV/dt <sup>(2)</sup>                | $V_D = 2/3 \times V_{DRM}$ , gate open    | $T_j = 150\text{ °C}$ | Min. | 1000   | 1500   | V/μs |
| (dI/dt) <sub>c</sub> <sup>(2)</sup> | Without snubber                           | $T_j = 150\text{ °C}$ | Min. | 33     | 44     | A/ms |

1. Minimum  $I_{GT}$  is guaranteed at 20% of  $I_{GT}$  max.

2. For both polarities of A2 referenced to A1.

**Table 3. Static characteristics**

| Symbol                        | Test conditions                                |                                   |      | Value | Unit          |
|-------------------------------|--|-----------------------------------|------|-------|---------------|
| $V_T^{(1)}$                   | $I_T = 42\text{ A}$ , $t_p = 380\ \mu\text{s}$ | $T_j = 25\text{ }^\circ\text{C}$  | Max. | 1.55  | V             |
| $V_{TO}^{(1)}$                | Threshold voltage                              | $T_j = 150\text{ }^\circ\text{C}$ | Max. | 0.80  | V             |
| $R_D^{(1)}$                   | Dynamic resistance                             | $T_j = 150\text{ }^\circ\text{C}$ | Max. | 15    | m $\Omega$    |
| $I_{DRM}/$<br>$I_{RRM}^{(2)}$ | $V_{DRM} = V_{RRM}$                            | $T_j = 25\text{ }^\circ\text{C}$  | Max. | 10    | $\mu\text{A}$ |
|                               |  | $T_j = 150\text{ }^\circ\text{C}$ |      | 8.5   | mA            |
|                               | $V_D = V_R = 400\text{ V}$ , peak voltage      | $T_j = 150\text{ }^\circ\text{C}$ | Max. | 7     | mA            |
|                               |  | $T_j = 150\text{ }^\circ\text{C}$ | Max. | 5.5   |               |

1. For both polarities of A2 referenced to A1.

2.  $t_p = 380\ \mu\text{s}$

**Table 4. Thermal resistance**

| Symbol        | Parameter  |                                 | Value | Unit               |
|---------------|--|---------------------------------|-------|--------------------|
| $R_{th(j-c)}$ | Junction to case (AC)                            | D <sup>2</sup> PAK,<br>TO-220AB | 0.8   | $^\circ\text{C/W}$ |
|               |  | TO-220AB Ins.                   | 1.6   |                    |
| $R_{th(j-a)}$ | Junction to ambient ( $S_{cu} = 2\text{ cm}^2$ ) | D <sup>2</sup> PAK,<br>TO-220AB | 45    | $^\circ\text{C/W}$ |
|               |  | TO-220AB Ins.                   | 60    |                    |

## 1.1 Characteristics (curves)

**Figure 1. Maximum power dissipation versus on-state RMS current**

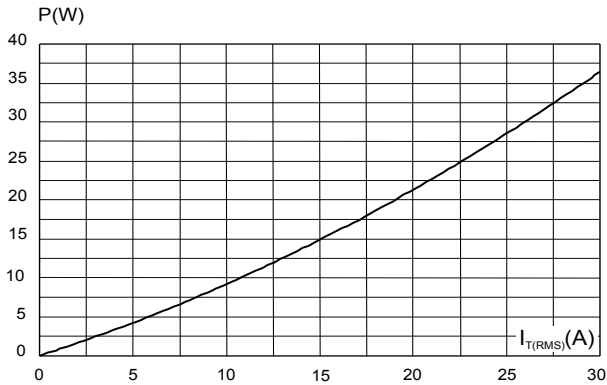

**Figure 2. On-state RMS current versus case temperature**

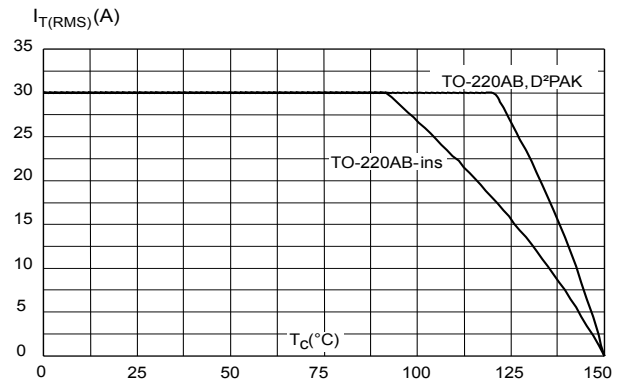

**Figure 3. On-state RMS current versus ambient temperature (free air convection)**

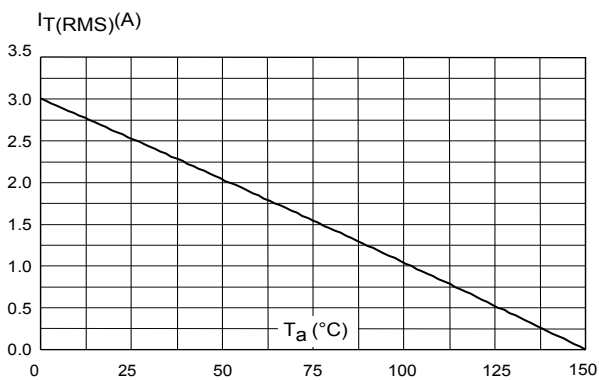

**Figure 4. Variation of thermal impedance versus pulse duration**

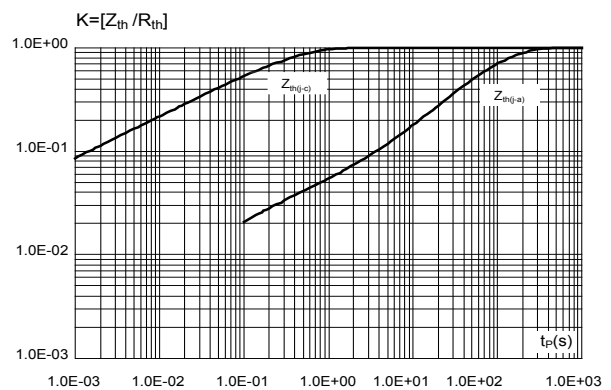

**Figure 5. Relative variation of gate trigger current and gate trigger voltage versus junction temperature**

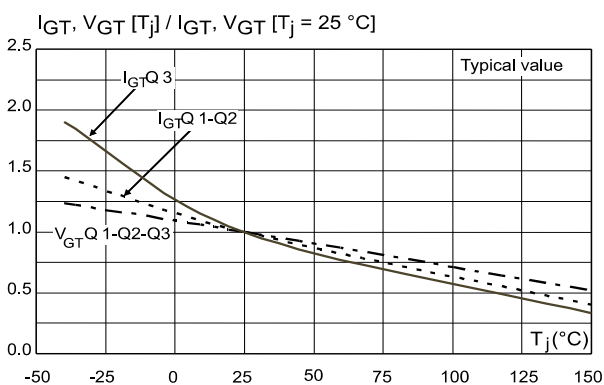

**Figure 6. Relative variation of holding current and latching current versus junction temperature (typical value)**

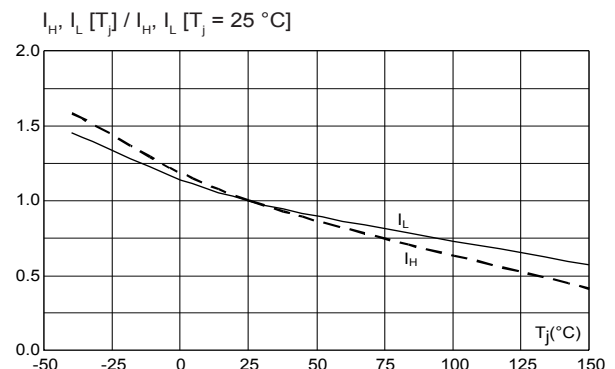

**Figure 7. Surge peak on-state current versus number of cycles**

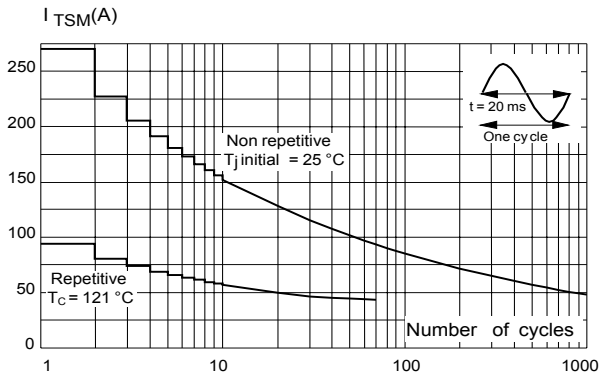

**Figure 8. Non-repetitive surge peak on-state current for a sinusoidal pulse with width  $t_p < 10$  ms**

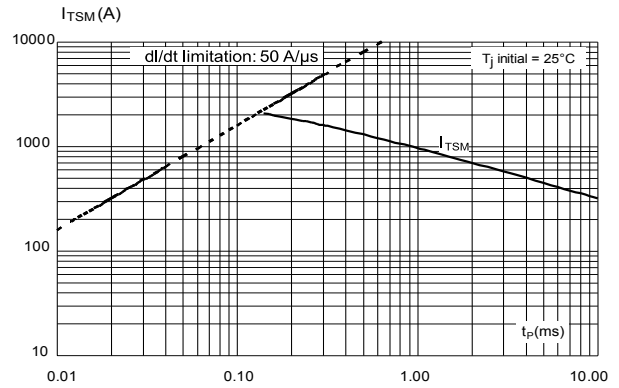

**Figure 9. On-state characteristics (maximum values)**

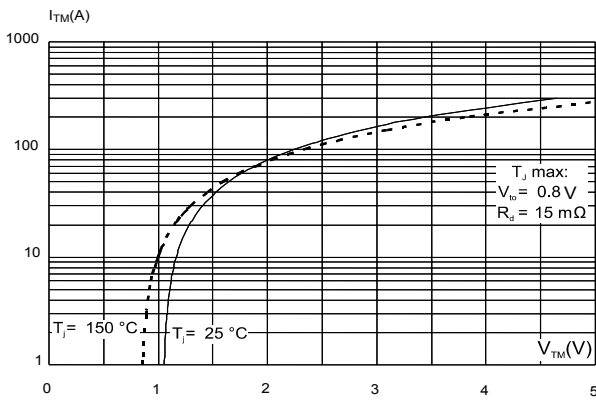

**Figure 10. Relative variation of critical rate of decrease of main current versus junction temperature**

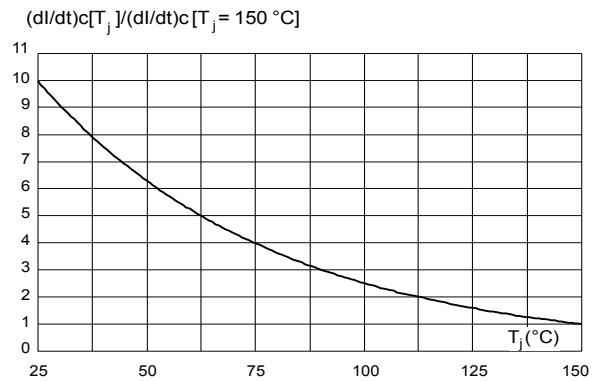

**Figure 11. Relative variation of static dV/dt immunity versus junction temperature**

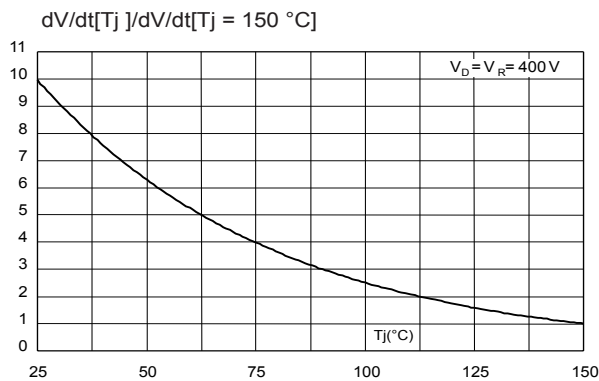

**Figure 12. Relative variation of leakage current versus junction temperature for different values of blocking voltage**

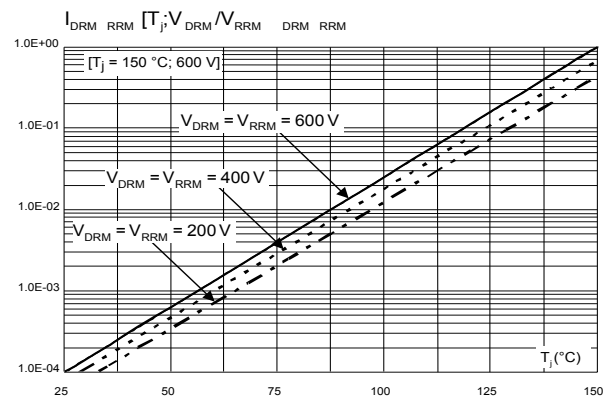

**Figure 13. Thermal resistance junction to ambient versus copper surface under tab**

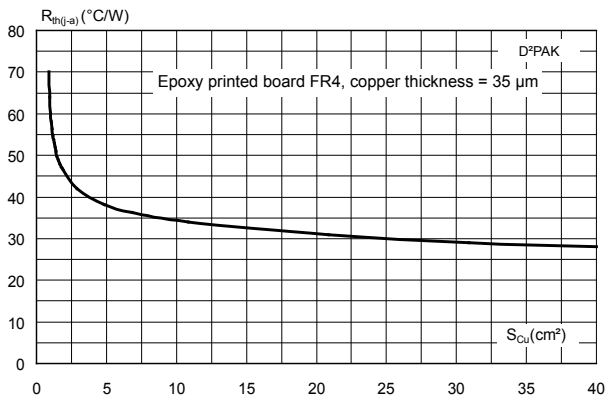

**Figure 14. Acceptable junction to ambient thermal resistance versus repetitive peak off-state voltage and ambient temperature**

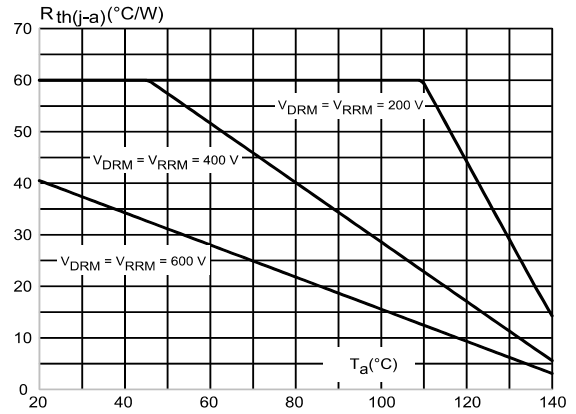

## 2 Package information

To meet environmental requirements, ST offers these devices in different grades of **ECOPACK** packages, depending on their level of environmental compliance. ECOPACK specifications, grade definitions, and product status are available at: [www.st.com](http://www.st.com). ECOPACK is an ST trademark.

### 2.1 D<sup>2</sup>PAK package information

Figure 15. D<sup>2</sup>PAK package outline

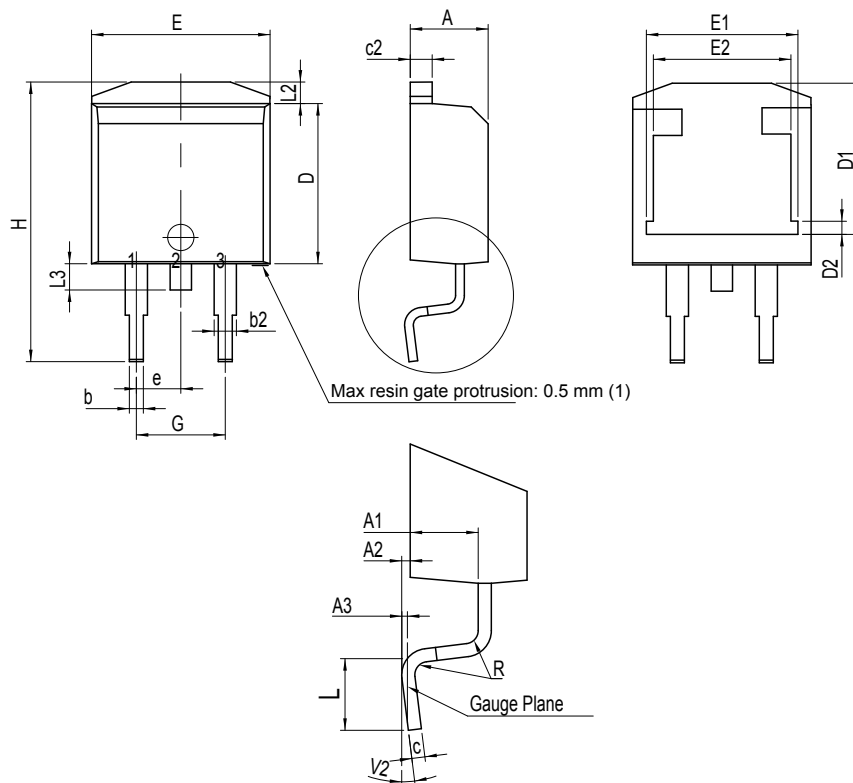

(1) Resin gate is accepted in each of position shown on the drawing, or their symmetrical.

**Table 5. D<sup>2</sup>PAK package mechanical data**

| Ref. | Dimensions  |      |       |                       |        |        |
|------|-------------|------|-------|-----------------------|--------|--------|
|      | Millimeters |      |       | Inches <sup>(1)</sup> |        |        |
|      | Min.        | Typ. | Max.  | Min.                  | Typ.   | Max.   |
| A    | 4.30        |      | 4.60  | 0.1693                |        | 0.1811 |
| A1   | 2.49        |      | 2.69  | 0.0980                |        | 0.1059 |
| A2   | 0.03        |      | 0.23  | 0.0012                |        | 0.0091 |
| A3   |             | 0.25 |       |                       | 0.0098 |        |
| b    | 0.70        |      | 0.93  | 0.0276                |        | 0.0366 |
| b2   | 1.25        |      | 1.7   | 0.0492                |        | 0.0669 |
| c    | 0.45        |      | 0.60  | 0.0177                |        | 0.0236 |
| c2   | 1.21        |      | 1.36  | 0.0476                |        | 0.0535 |
| D    | 8.95        |      | 9.35  | 0.3524                |        | 0.3681 |
| D1   | 7.50        |      | 8.00  | 0.2953                |        | 0.3150 |
| D2   | 1.30        |      | 1.70  | 0.0512                |        | 0.0669 |
| e    | 2.54        |      |       | 0.1                   |        |        |
| E    | 10.00       |      | 10.28 | 0.3937                |        | 0.4047 |
| E1   | 8.30        |      | 8.70  | 0.3268                |        | 0.3425 |
| E2   | 6.85        |      | 7.25  | 0.2697                |        | 0.2854 |
| G    | 4.88        |      | 5.28  | 0.1921                |        | 0.2079 |
| H    | 15          |      | 15.85 | 0.5906                |        | 0.6240 |
| L    | 1.78        |      | 2.28  | 0.0701                |        | 0.0898 |
| L2   | 1.27        |      | 1.40  | 0.0500                |        | 0.0551 |
| L3   | 1.40        |      | 1.75  | 0.0551                |        | 0.0689 |
| R    |             | 0.40 |       |                       | 0.0157 |        |
| V2   | 0°          |      | 8°    | 0°                    |        | 8°     |

1. Dimensions in inches are given for reference only

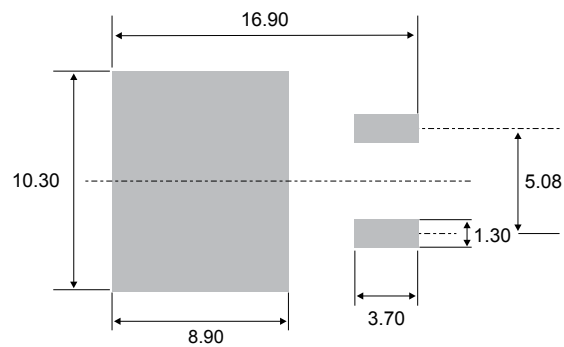
**Figure 16. D<sup>2</sup>PAK recommended footprint (dimensions are in mm)**



## 2.2 TO-220AB package information

- Molding compound resin is halogen-free and meets flammability standard UL94 level 0
- Lead-free package leads finishing
- ECOPACK2 compliant
- Recommended torque value: 0.55 N·m
- Maximum torque value: 0.70 N·m

Figure 17. TO-220AB package outline

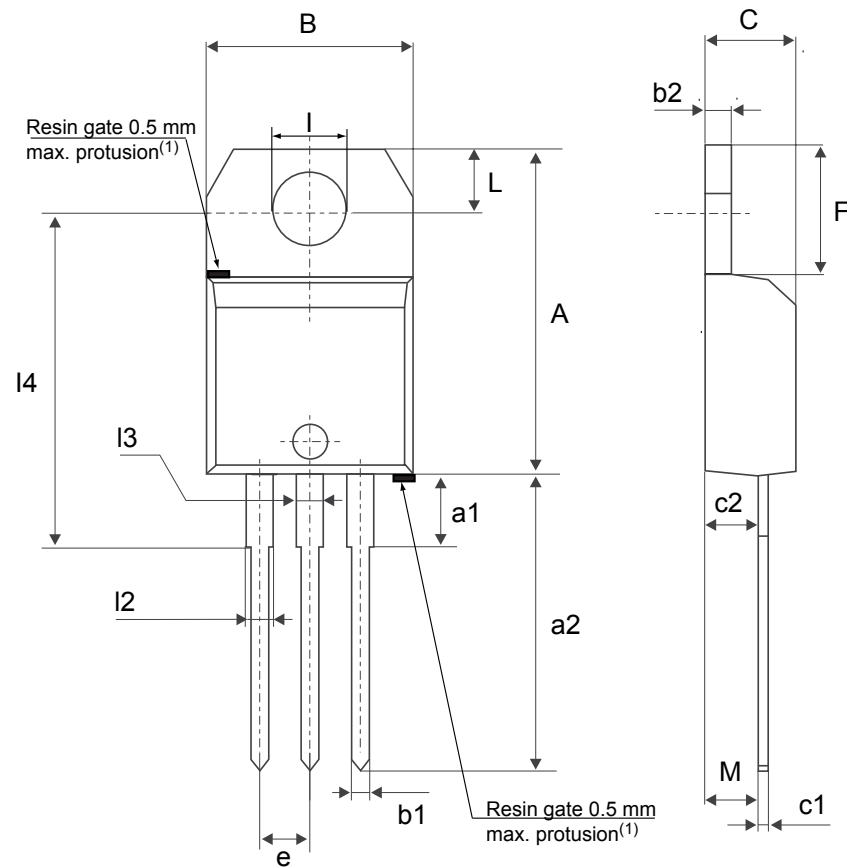

(1) Resin gate position accepted in one of the two positions or in the symmetrical opposites.

**Table 6. TO-220AB package mechanical data**

| Ref. | Dimensions  |       |       |                       |        |        |
|------|-------------|-------|-------|-----------------------|--------|--------|
|      | Millimeters |       |       | Inches <sup>(1)</sup> |        |        |
|      | Min.        | Typ.  | Max.  | Min.                  | Typ.   | Max.   |
| A    | 15.20       |       | 15.90 | 0.5984                |        | 0.6260 |
| a1   |             | 3.75  |       |                       | 0.1476 |        |
| a2   | 13.00       |       | 14.00 | 0.5118                |        | 0.5512 |
| B    | 10.00       |       | 10.40 | 0.3937                |        | 0.4094 |
| b1   | 0.61        |       | 0.88  | 0.0240                |        | 0.0346 |
| b2   | 1.23        |       | 1.32  | 0.0484                |        | 0.0520 |
| C    | 4.40        |       | 4.60  | 0.1732                |        | 0.1811 |
| c1   | 0.49        |       | 0.70  | 0.0193                |        | 0.0276 |
| c2   | 2.40        |       | 2.72  | 0.0945                |        | 0.1071 |
| e    | 2.40        |       | 2.70  | 0.0945                |        | 0.1063 |
| F    | 6.20        |       | 6.60  | 0.2441                |        | 0.2598 |
| I    | 3.73        |       | 3.88  | 0.1469                |        | 0.1528 |
| L    | 2.65        |       | 2.95  | 0.1043                |        | 0.1161 |
| I2   | 1.14        |       | 1.70  | 0.0449                |        | 0.0669 |
| I3   | 1.14        |       | 1.70  | 0.0449                |        | 0.0669 |
| I4   | 15.80       | 16.40 | 16.80 | 0.6220                | 0.6457 | 0.6614 |
| M    |             | 2.6   |       |                       | 0.1024 |        |

1. Inch dimensions are for reference only.

### 3 Ordering information

Figure 18. Ordering information scheme

Table 7.

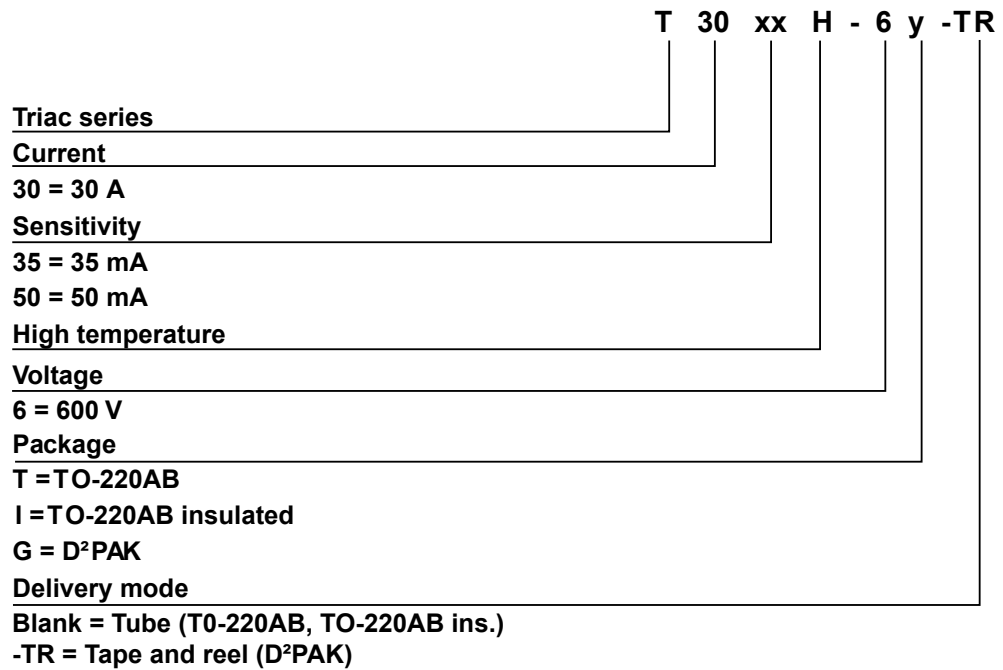

#### Ordering information

| Order code   | Marking   | Package            | Weight | Base qty. | Delivery mode     |
|--------------|-----------|--------------------|--------|-----------|-------------------|
| T3035H-6G    | T3035H-6G | D <sup>2</sup> PAK | 1.5 g  | 50        | Tube              |
| T3035H-6G-TR | T3035H-6G |                    |        | 1000      | Tape and reel 13" |
| T3035H-6I    | T3035H-6I | TO-220AB Ins.      | 2.3 g  | 50        | Tube              |
| T3035H-6T    | T3035H-6T | TO-220AB           | 2.3 g  | 50        | Tube              |
| T3050H-6G    | T3050H-6G | D <sup>2</sup> PAK | 1.5 g  | 50        | Tube              |
| T3050H-6G-TR | T3050H-6G |                    |        | 1000      | Tape and reel 13" |
| T3050H-6T    | T3050H-6T | TO-220AB           | 2.3 g  | 50        | Tube              |

## Revision history

**Table 8. Document revision history**

| Date        | Version | Changes  |
|-------------|---------|--|
| 28-Jan-2010 | 1       | Initial release.   |
| 17-May-2010 | 2       | Updated maximum Tj in <i>Table 2</i> .                                 |
| 14-Dec-2010 | 3       | Updated IGT in <i>Table 1</i> .  |
| 20-Sep-2011 | 4       | Updated: <i>Features</i> .   |
| 21-Jul-2015 | 5       | Update <i>Table 2</i> and reformatted to current standard.             |
| 20-Jan-2017 | 6       | D <sup>2</sup> PAK package added.                                      |
| 17-Nov-2021 | 7       | Updated <i>Description</i> and <i>Table 2</i> .<br>Minor text changes. |
| 29-Apr-2022 | 8       | Updated <i>Table 2</i> and <i>Table 7</i> .                            |
| 26-Jun-2025 | 9       | Updated <a href="#">Figure 7</a> .                                     |

**IMPORTANT NOTICE – READ CAREFULLY**

STMicroelectronics NV and its subsidiaries (“ST”) reserve the right to make changes, corrections, enhancements, modifications, and improvements to ST products and/or to this document at any time without notice. Purchasers should obtain the latest relevant information on ST products before placing orders. ST products are sold pursuant to ST’s terms and conditions of sale in place at the time of order acknowledgment.

Purchasers are solely responsible for the choice, selection, and use of ST products and ST assumes no liability for application assistance or the design of purchasers’ products.

No license, express or implied, to any intellectual property right is granted by ST herein.

Resale of ST products with provisions different from the information set forth herein shall void any warranty granted by ST for such product.

ST and the ST logo are trademarks of ST. For additional information about ST trademarks, refer to [www.st.com/trademarks](http://www.st.com/trademarks). All other product or service names are the property of their respective owners.

Information in this document supersedes and replaces information previously supplied in any prior versions of this document.

© 2025 STMicroelectronics – All rights reserved